

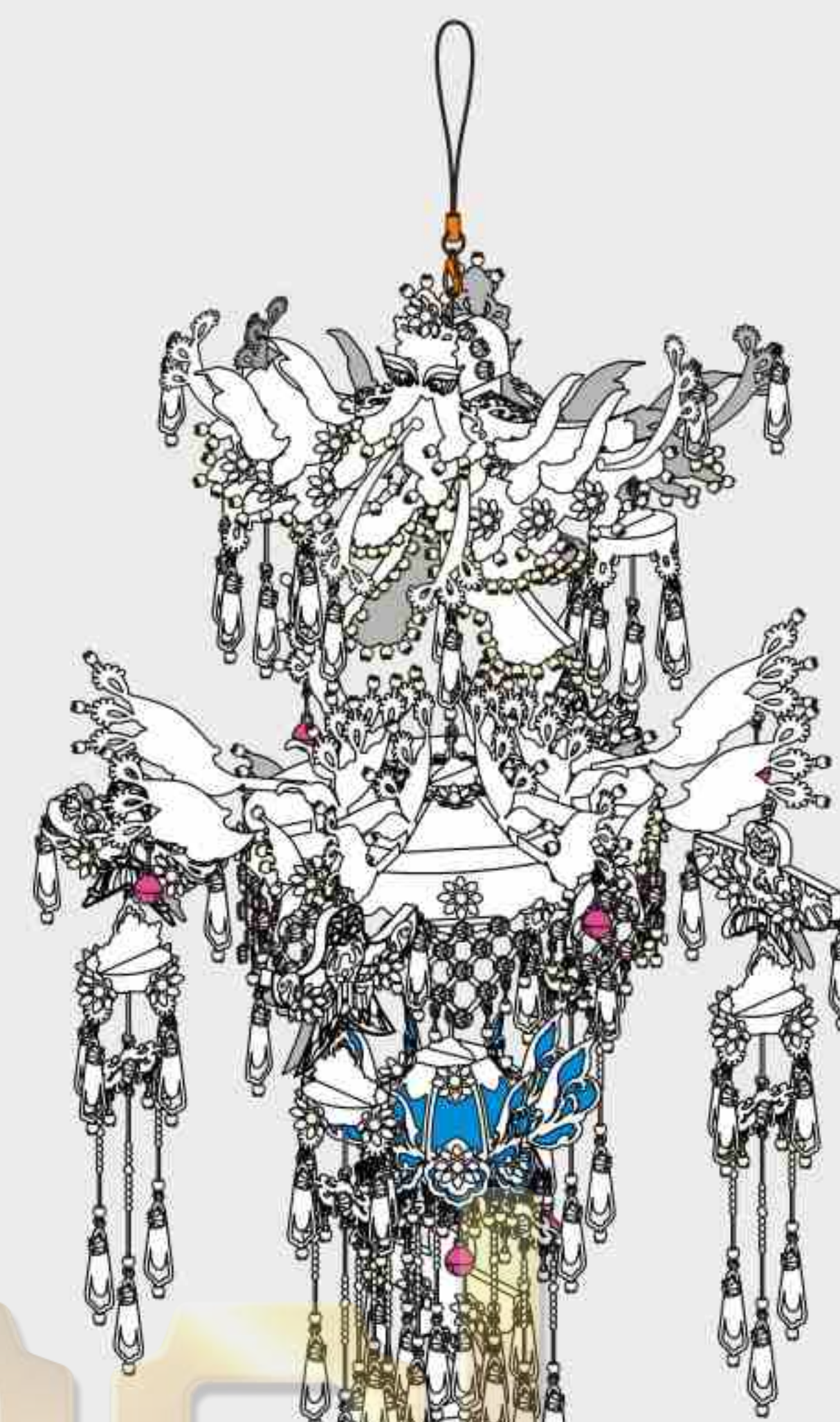

成品尺寸 Assembled model size  
≈L14.5cm×W14.5cm×40cm(含挂绳)



挑战星级 Difficulty Level



春风起，鸢铃响，  
一响一春，春启运来。  
拼酷凝非遗之韵，取纸鸢之形，留风铃之声，  
将宋时春意变为可长久相伴的信物。  
春逸·纸鸢铃，  
让千年回响栖于你的窗前。

商品信息:

产品名称: 春逸·纸鸢铃  
产品型号: P470  
产品材质: 430不锈钢  
成品尺寸: ≈L14.5cm×W14.5cm×H40cm(含挂绳)  
适用年龄: 15岁以上

官方服务中心:



- 免费补件
- 专属客服
- 视频教程
- 社群交流

内含金属片:

金属片数: 11cm×21cm×6(Pcs)+733配件



补件流程:



进入拼酷公众号/官网



选择【零件补给】程序



根据商品编号/类别/年份  
查找对应商品



填写零件补给表单



支付邮费



等待收件

\*零件补给服务具体条款、服务范围、邮费标准,请参考【零件补给】程序的服务说明,  
服务最终解释权归微石所有。



组装时请小心处理金属零件,以防划伤!

Please handle metal sheets with care,  
The parts may have sharp edges that  
could cut or scratch skin.  
Keep away from Children.

(1) 准备工具:

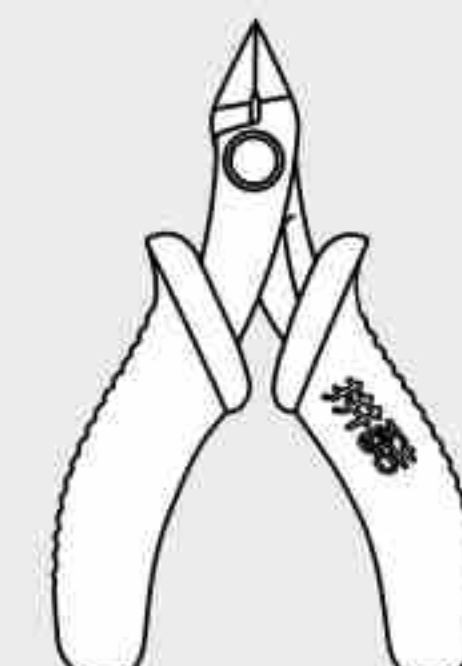

水口钳工具

修剪金属片板件  
上的零件水口位



尖嘴钳工具

弯折金属零件上  
的折叠线和扣点

\*建议使用拼酷正品拼装工具(水口钳、尖嘴钳)  
拼装时更省心、省力,拼装后作品更精细、美观!

(2) 取下零件:



使用水口钳剪断金属零件上的水口,  
将需要的金属零件从金属片板件取下。

(3) 识别零件:

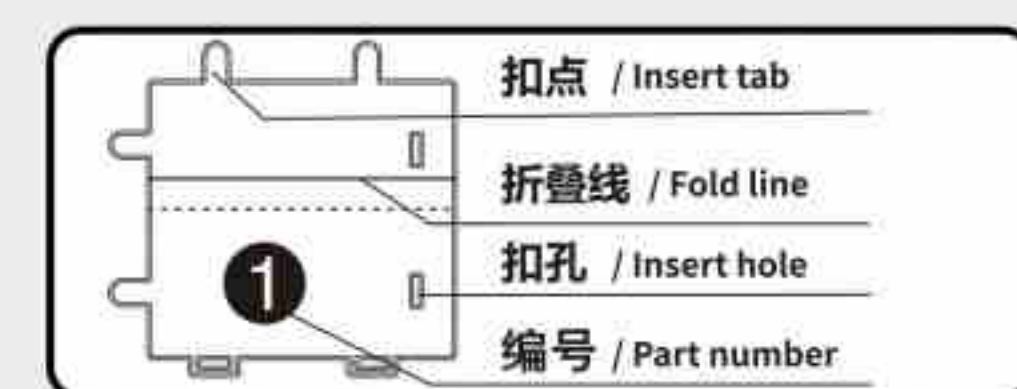

零件编号在金属片板件背面  
识别金属零件上的扣点、折叠线、扣孔的样子。

(4) 折叠零件:

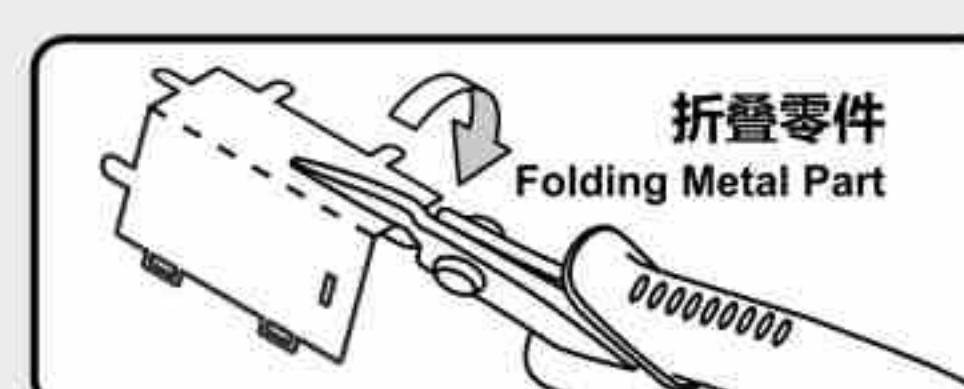

使用尖嘴钳,参照拼装说明书将金属零件折成形状。

(5) 固定零件:



扣点插入扣孔,旋转90°固定零件,再平折。

(6) 注意事项:

- 纹 颜色面  
纹理面
- 非 非颜色面  
非纹理面
- 正 零件正面
- 背 零件背面  
或编号面
- 注意细节
- 注意片对称
- 注意颜色和  
纹理不在同一  
面时

剪金属零件时请剪零件“水口位”,请勿将“扣点”当成“水口位”剪下,每次剪零件时请仅剪当前步骤的零件,切勿一次性将所有零件全部剪下,避免丢失;

当遇到折叠线的零件,请注意金属片的正反面及拼折方向,请按照说明书的方向,轻剪慢折,最好一次性折叠完成,请勿反复折叠,避免零件损坏。

拼装步骤:

Step 01

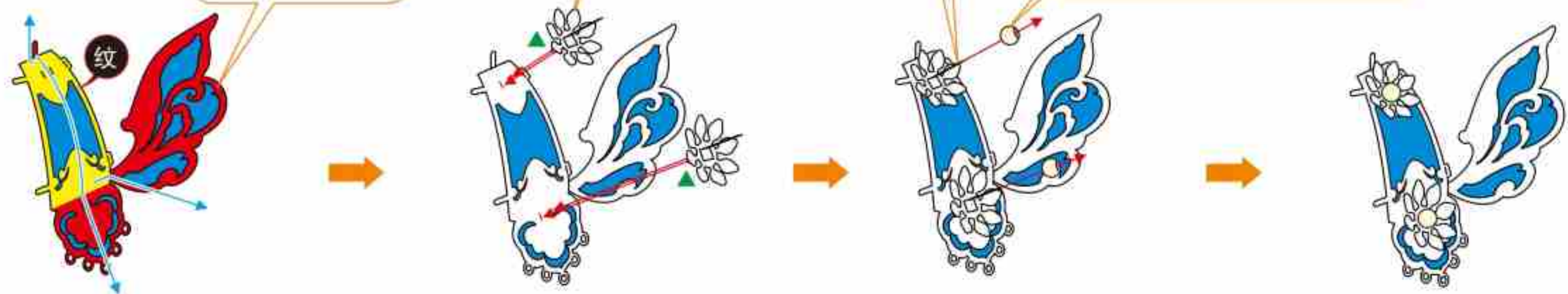
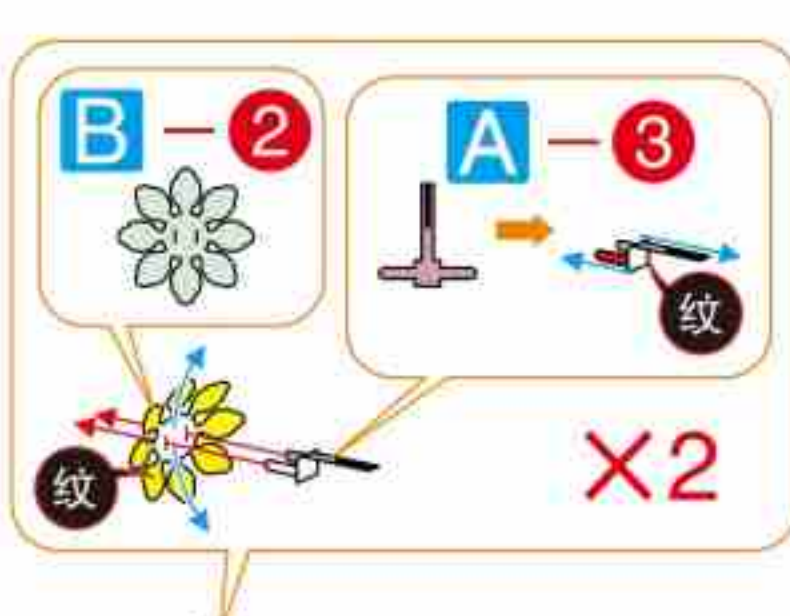
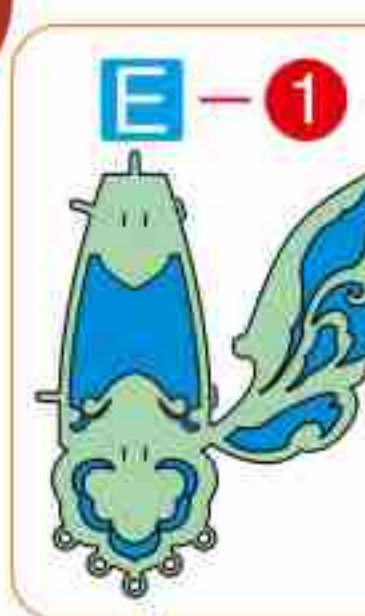

1号白色小珠子 X 2

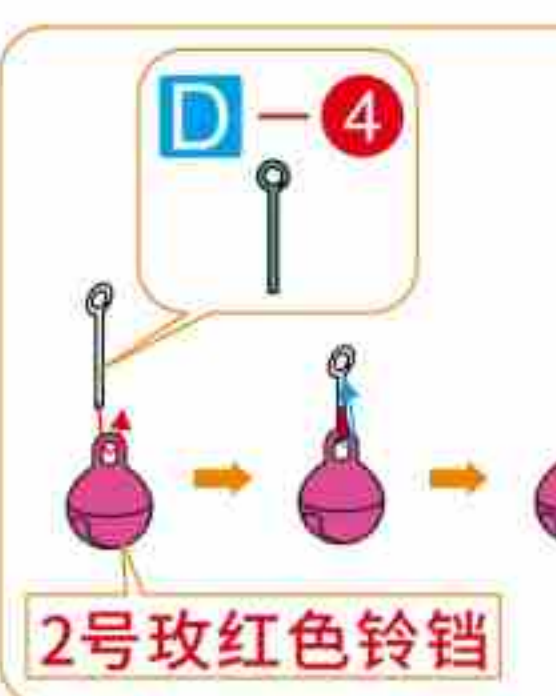

1号白色小珠子 X 4



Step 02

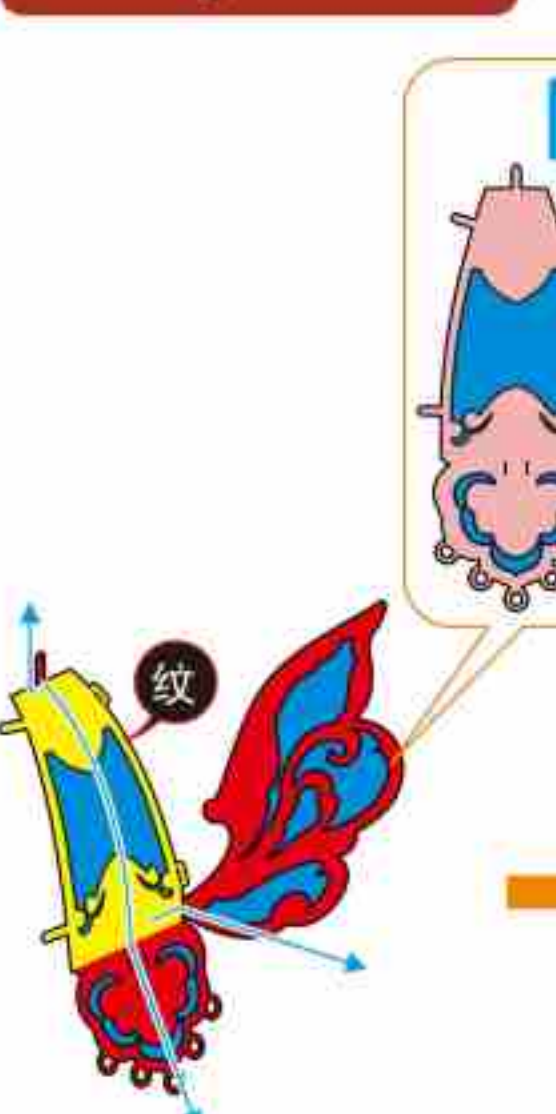

1号白色小珠子 X 4

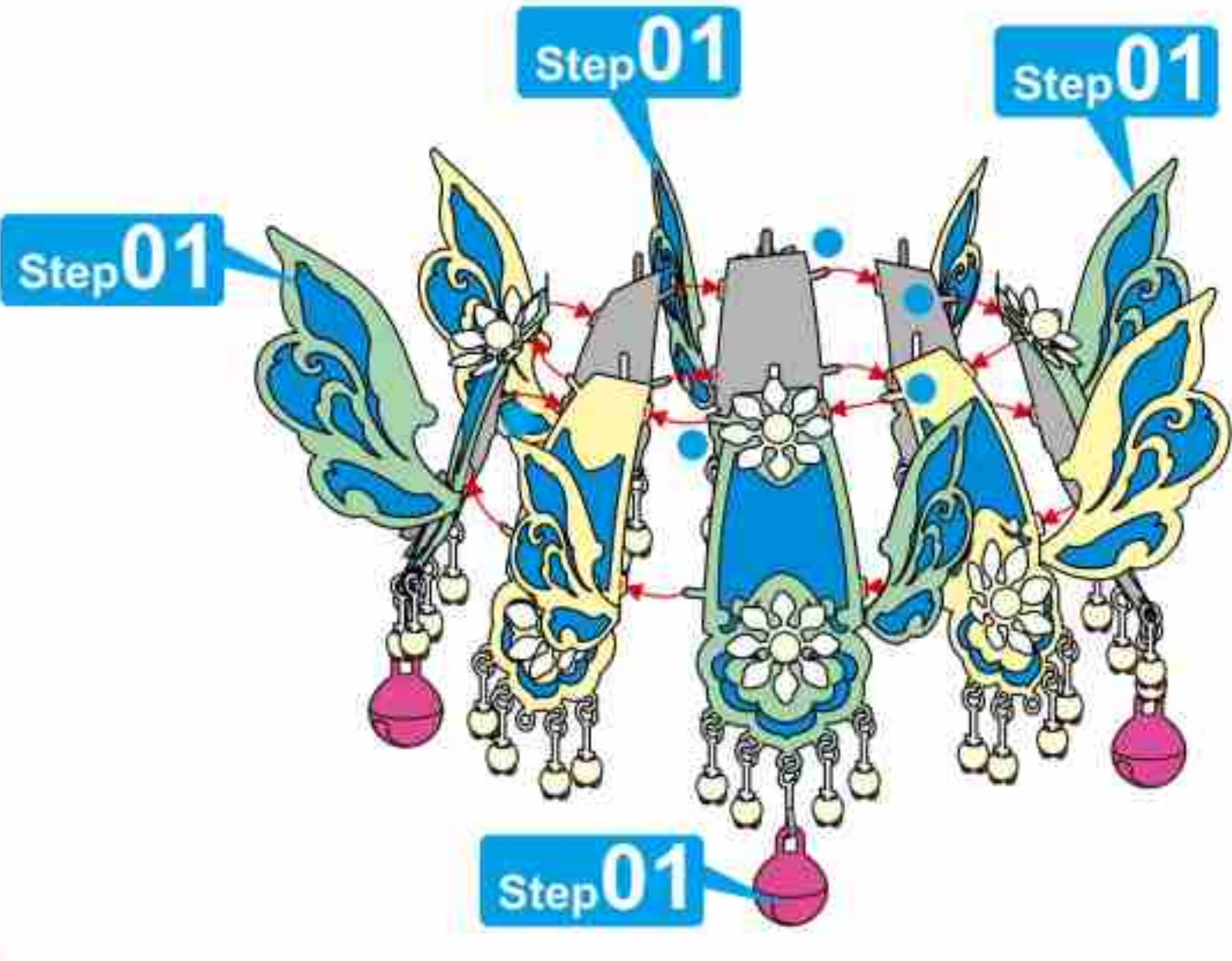

Step 01

Step 01

Step 01

Step 01

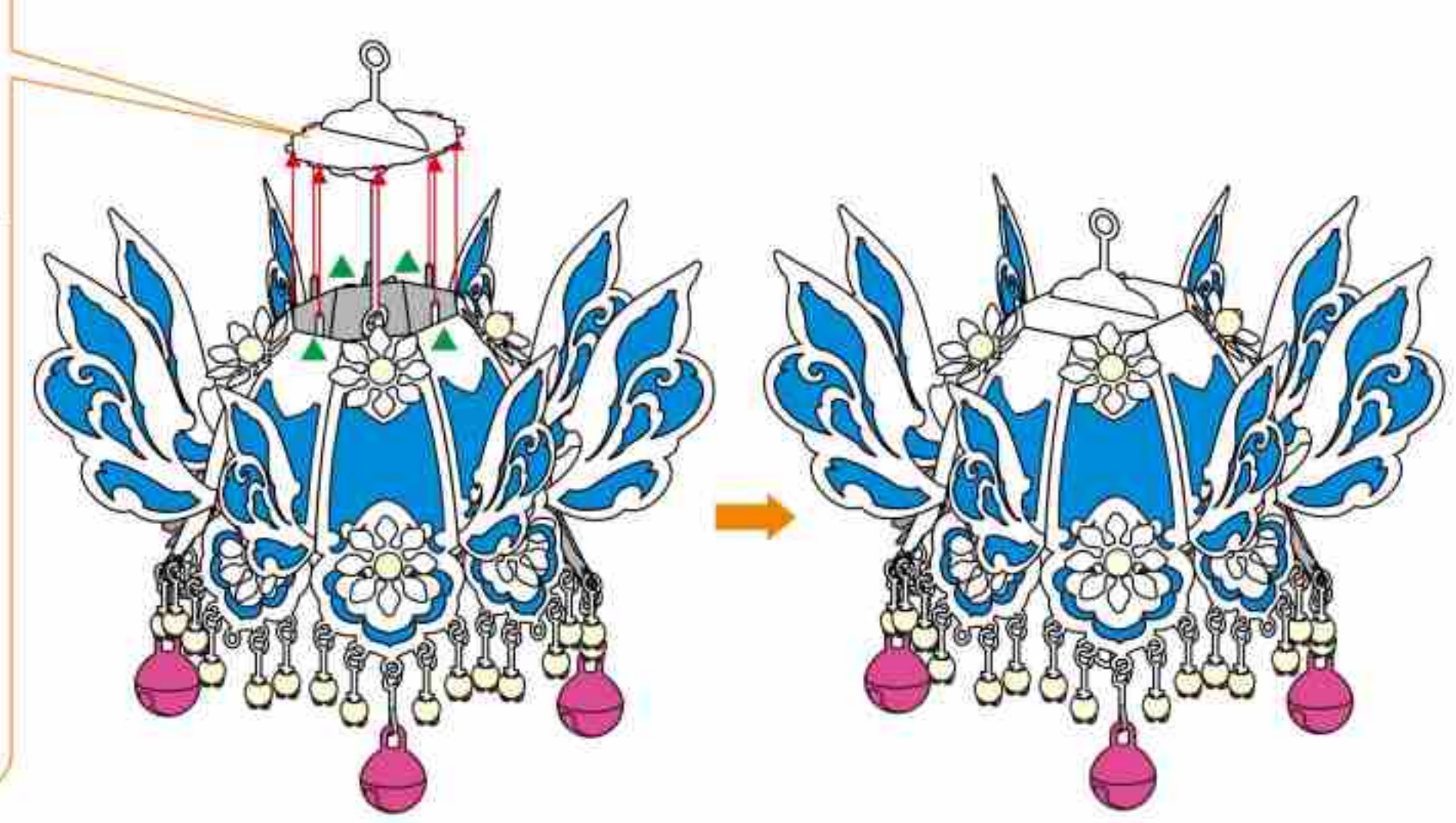
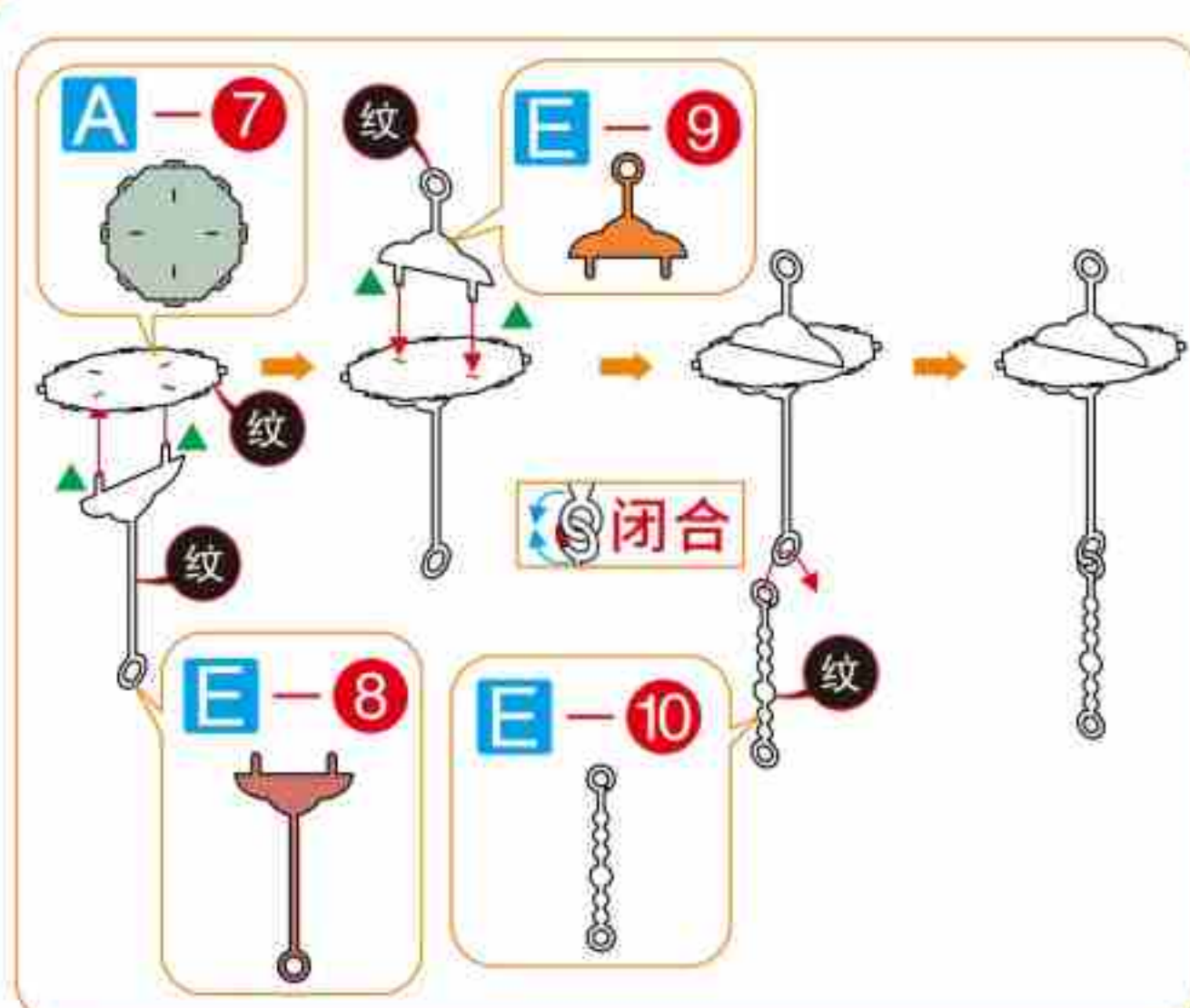

Step 03

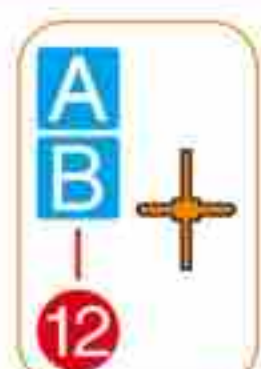

3号透明半珠子

1号白色小珠子 X 2

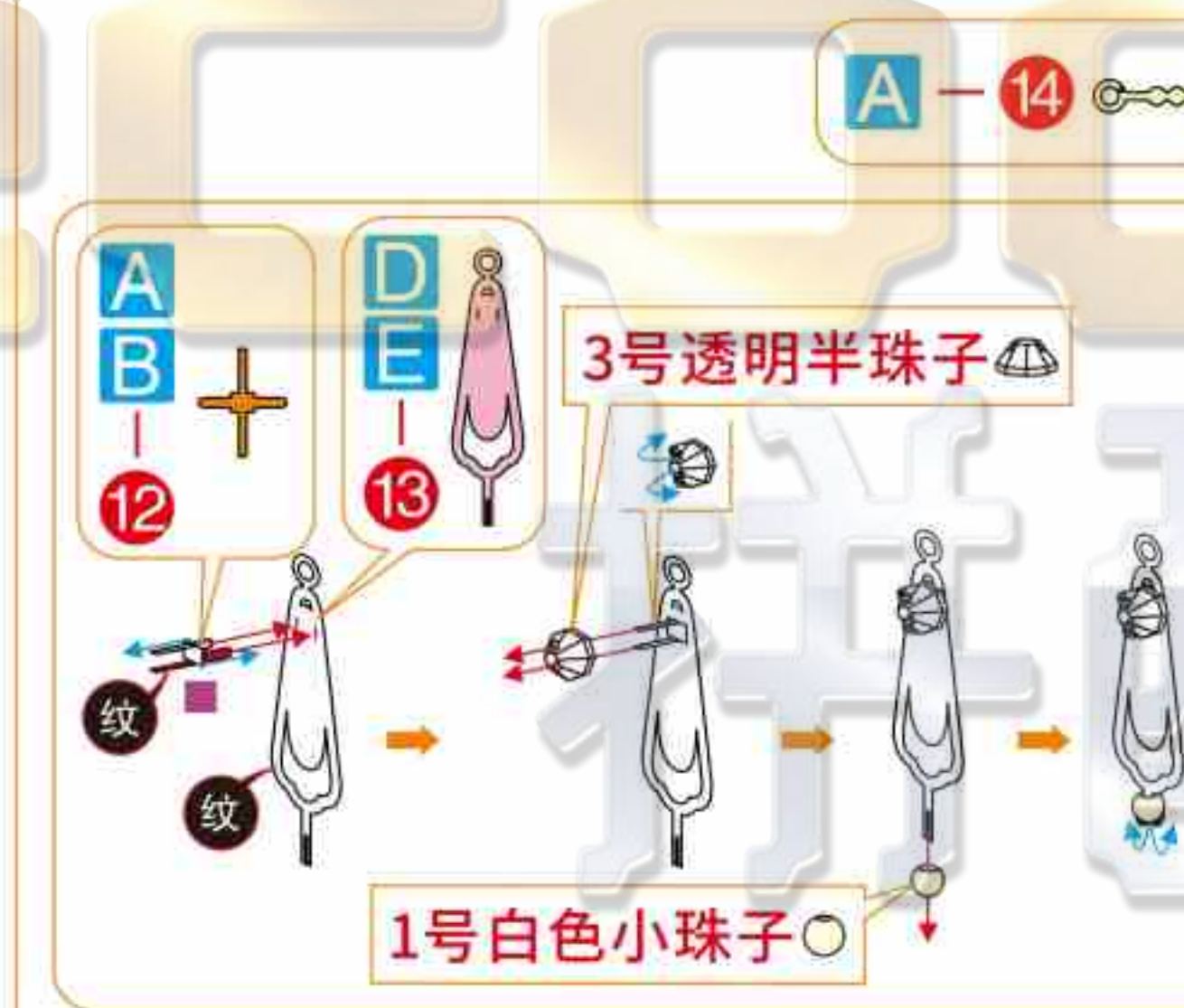

3号透明半珠子

1号白色小珠子

1号白色小珠子

X 3

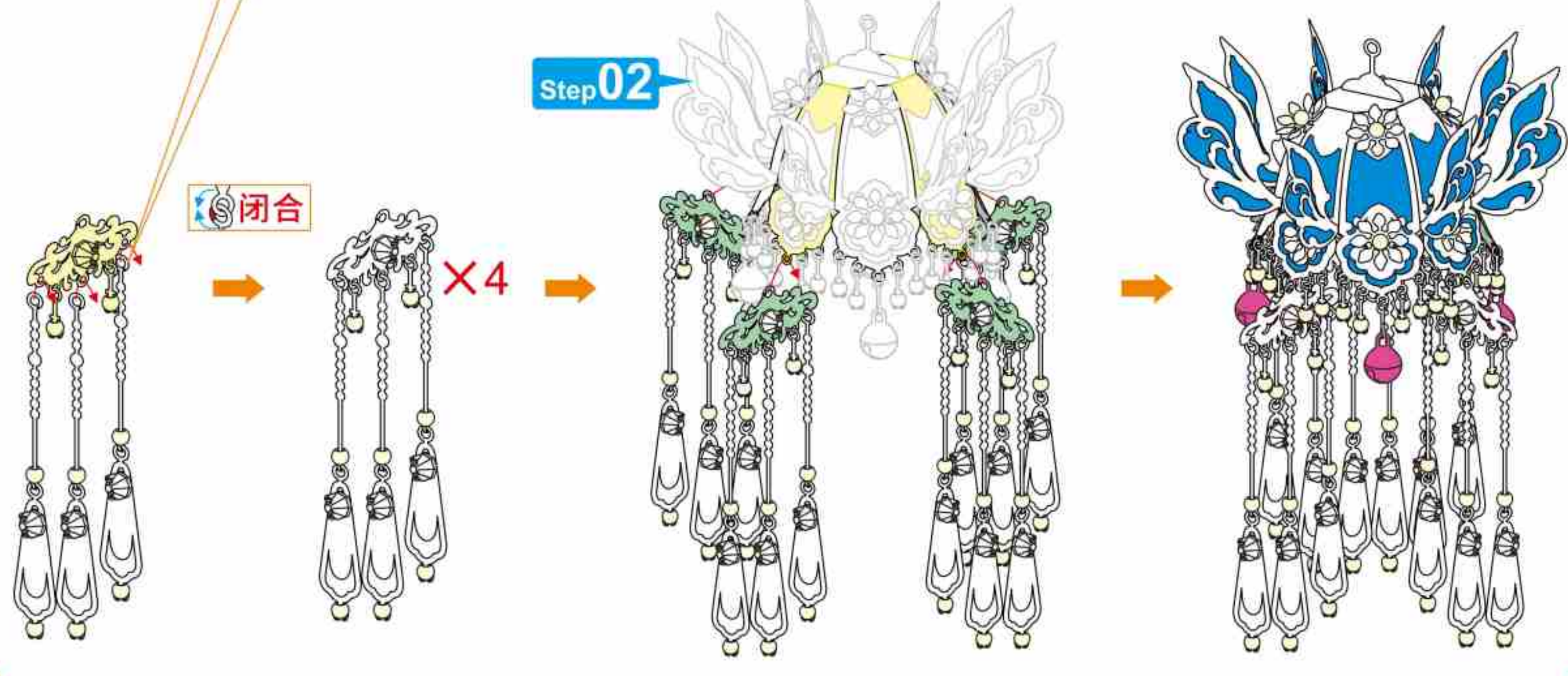

Step 02

Step 01

Step 01

X 4

1 2

3 4

Step 04

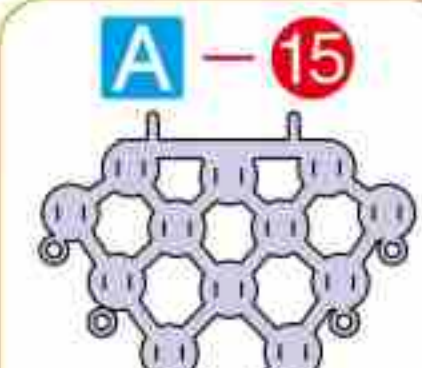

AB-12 X 4

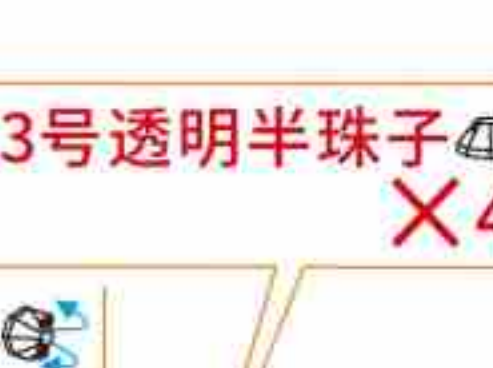

3号透明半珠子 X 4



AB-12 X 4



Step 04

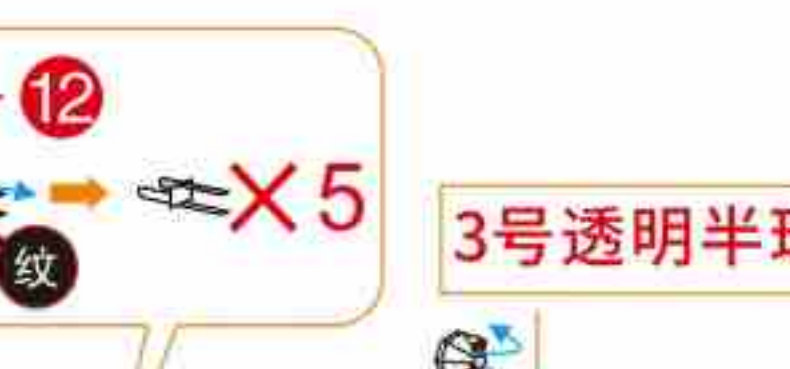
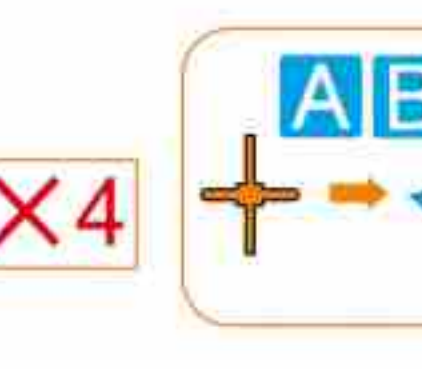

AB-12 X 5



3号透明半珠子 X 5



CEF-5 X 5



1号白色小珠子 X 6



Step 05



D-16 X 2

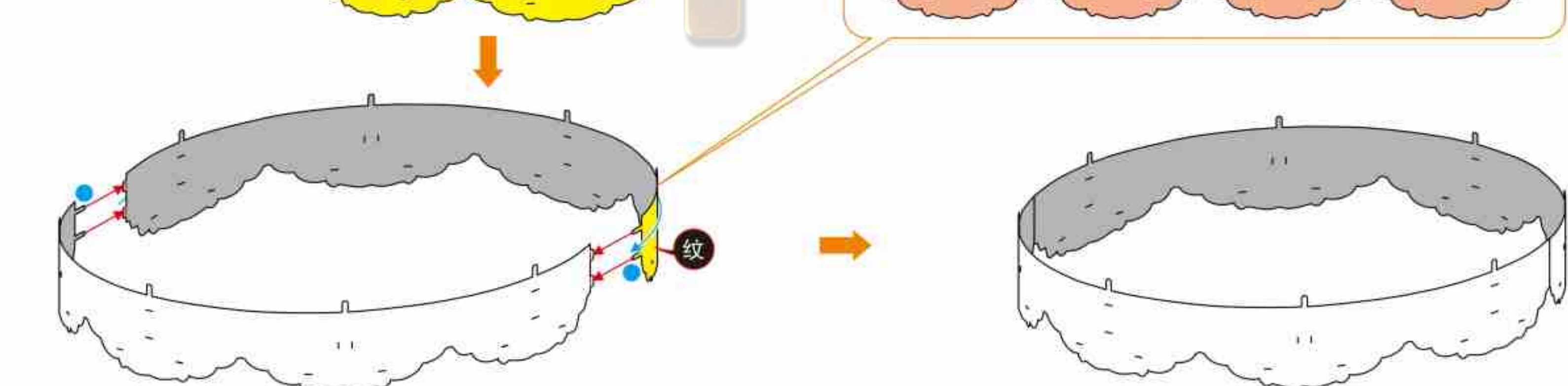

Step 04 X 8

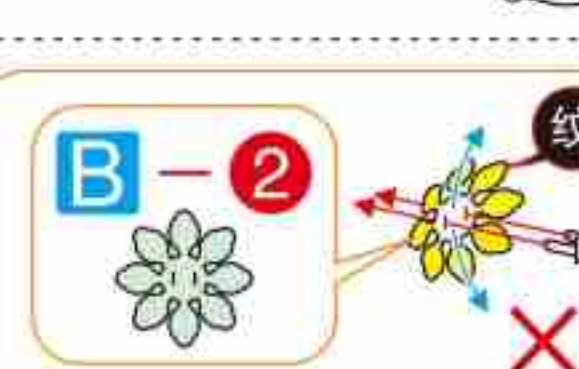

B-2 X 4

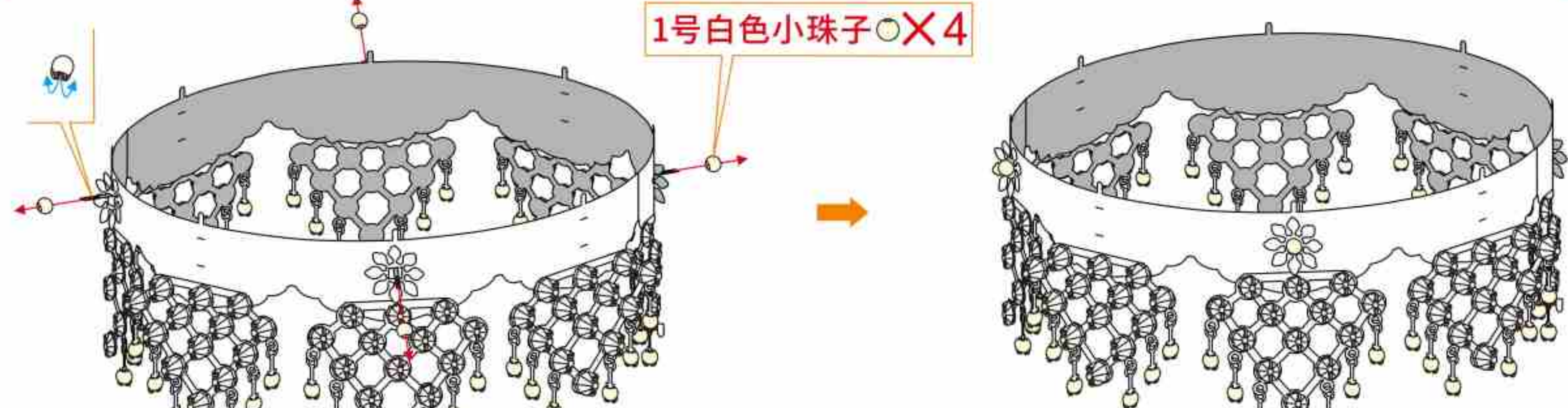
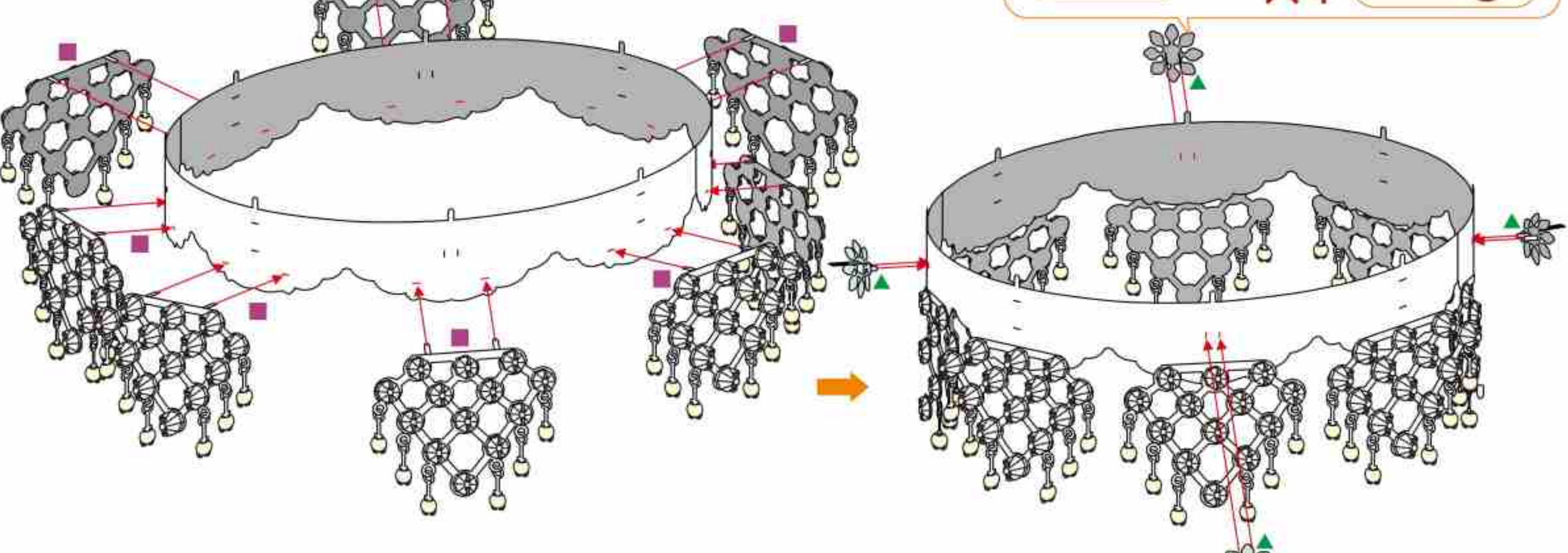

1号白色小珠子 X 4

Step 06

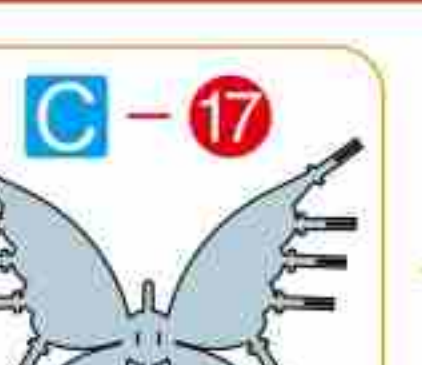

1号白色小珠子 X 10

1号白色小珠子

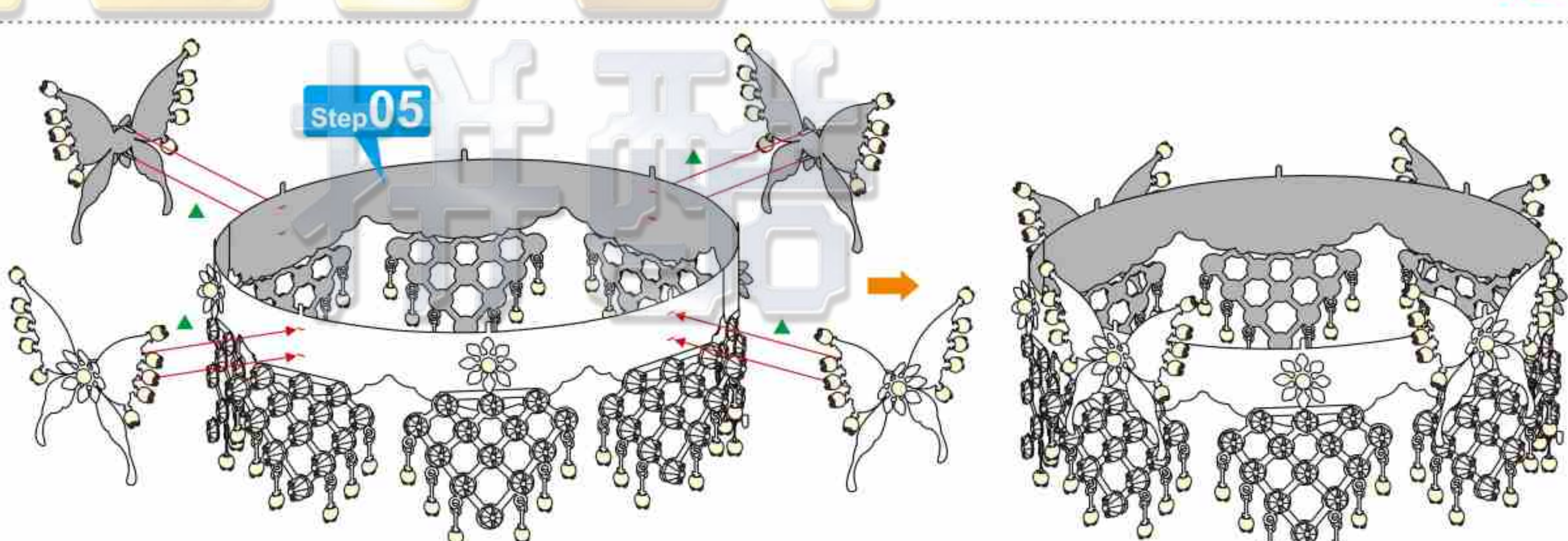

Step 05

Step 07

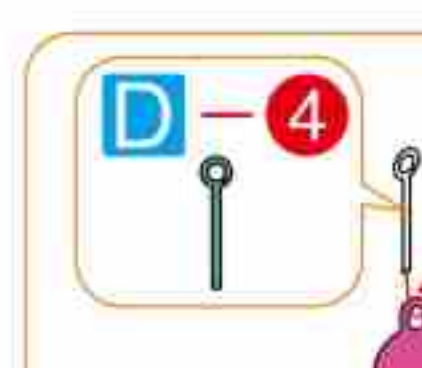

2号玫红色铃铛



1号白色小珠子 X 3

X 4

Step 08

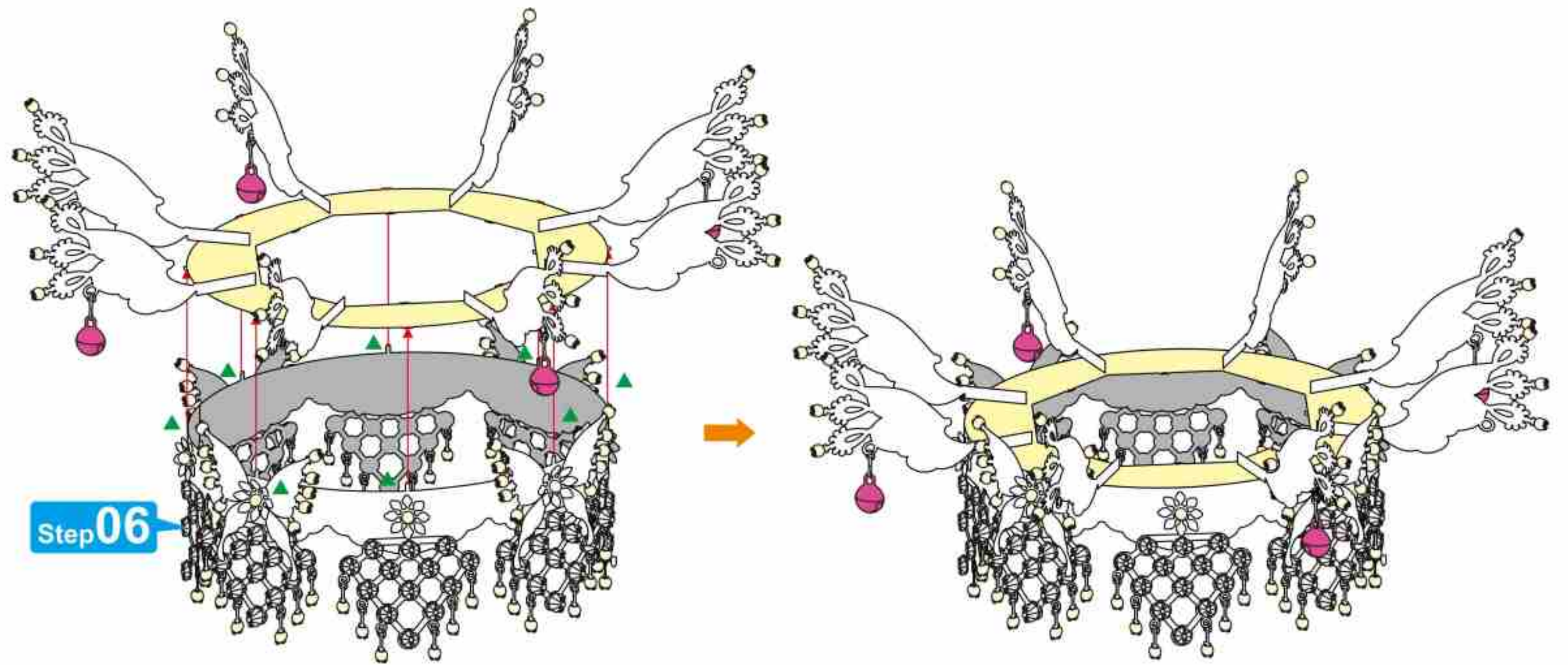
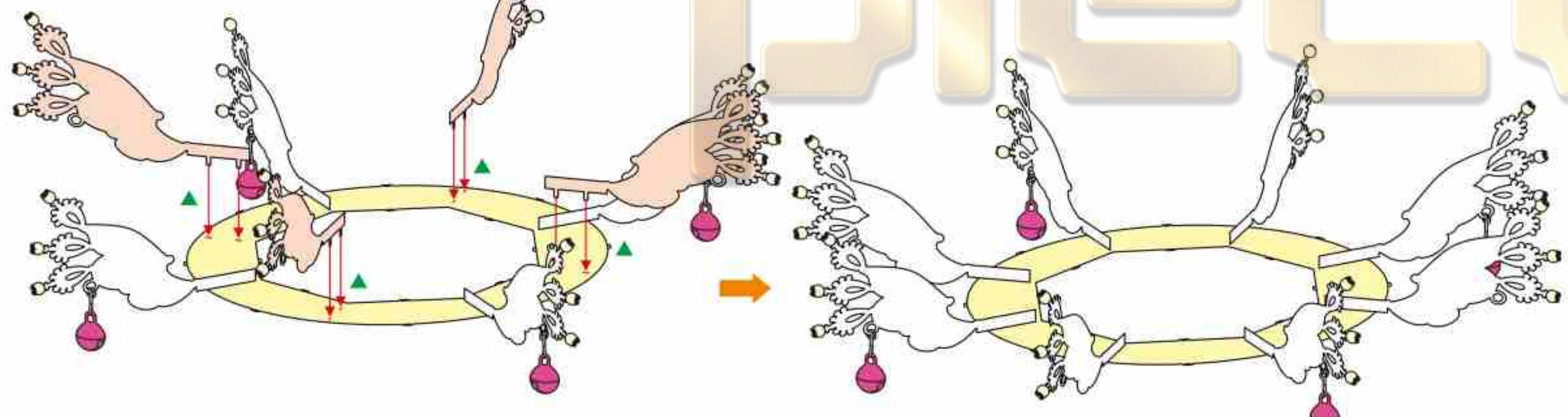
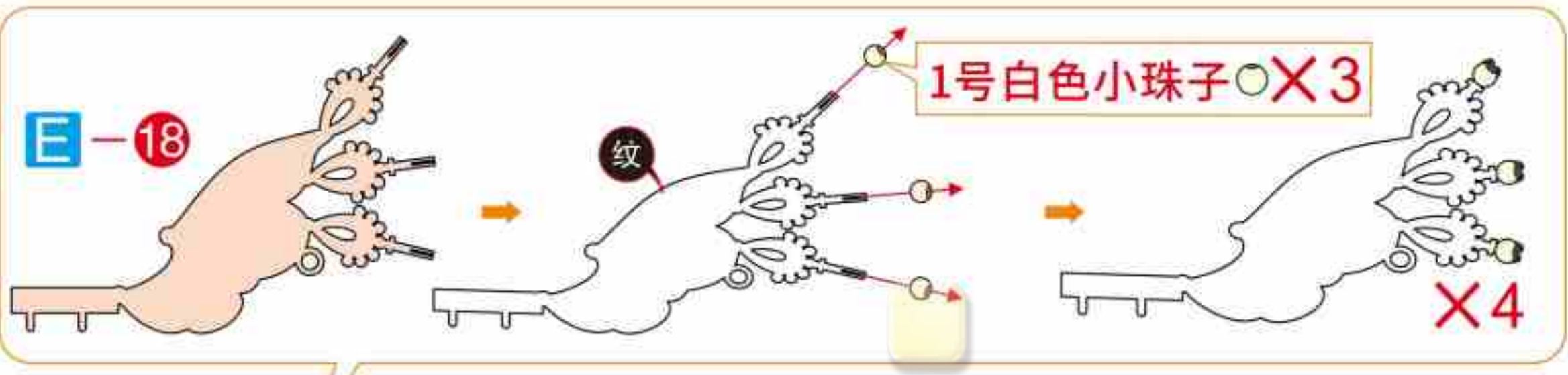
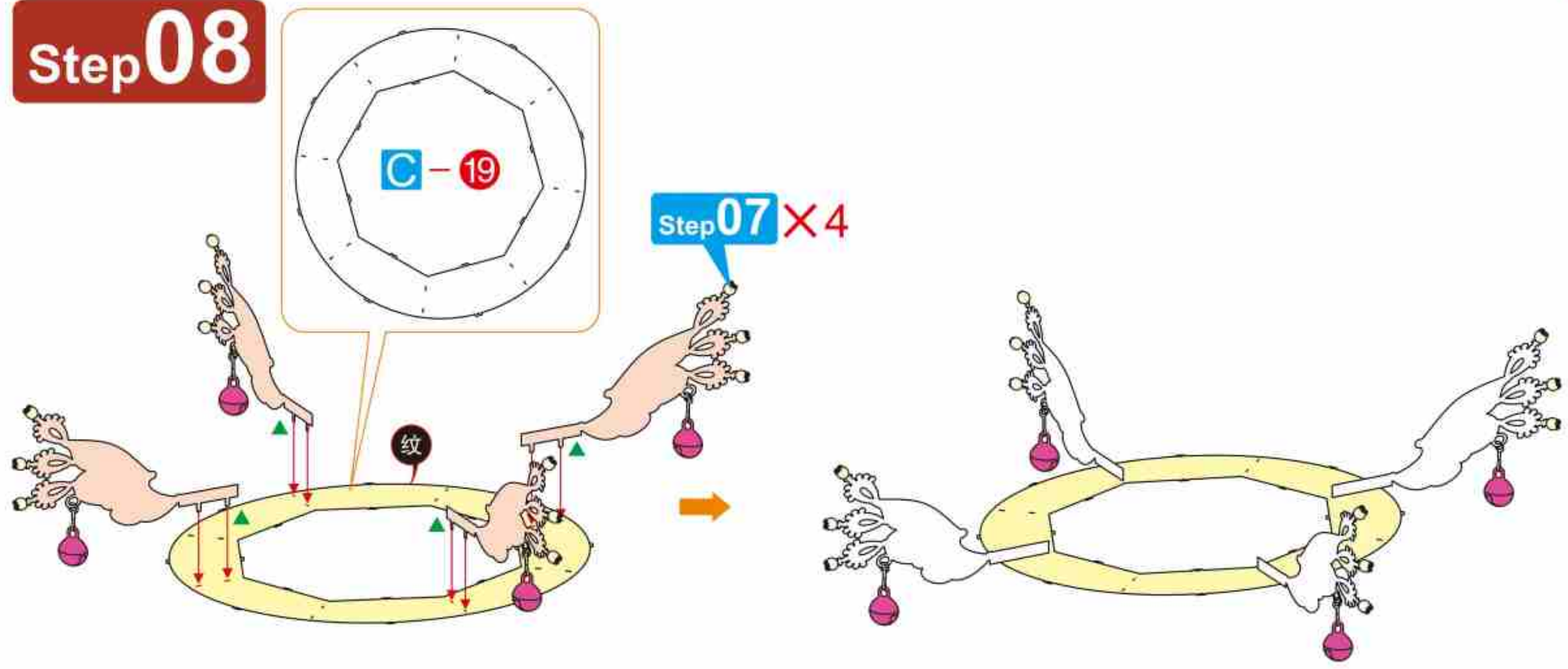

Step 09

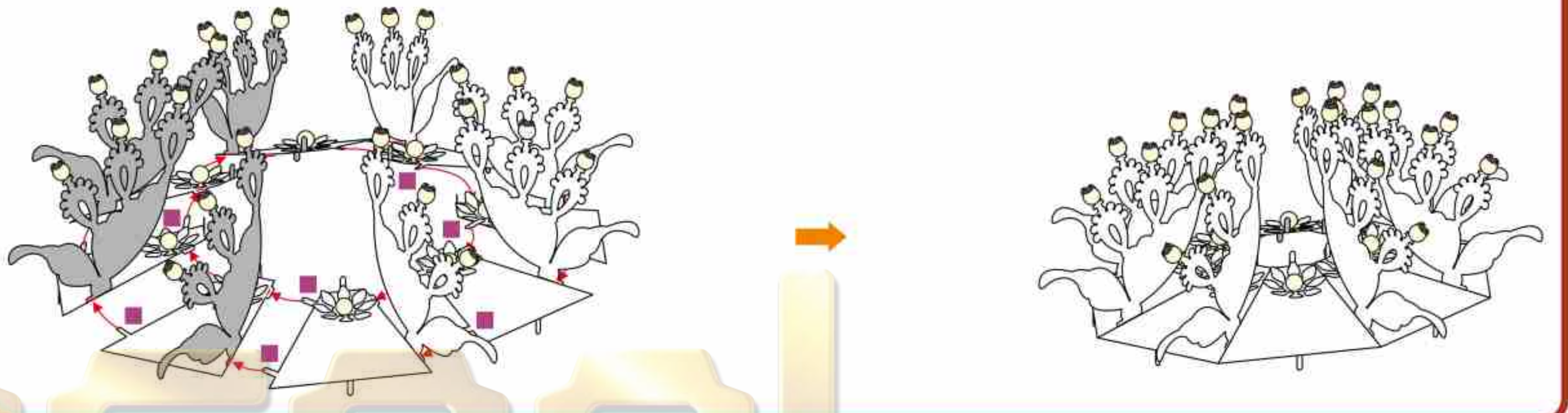
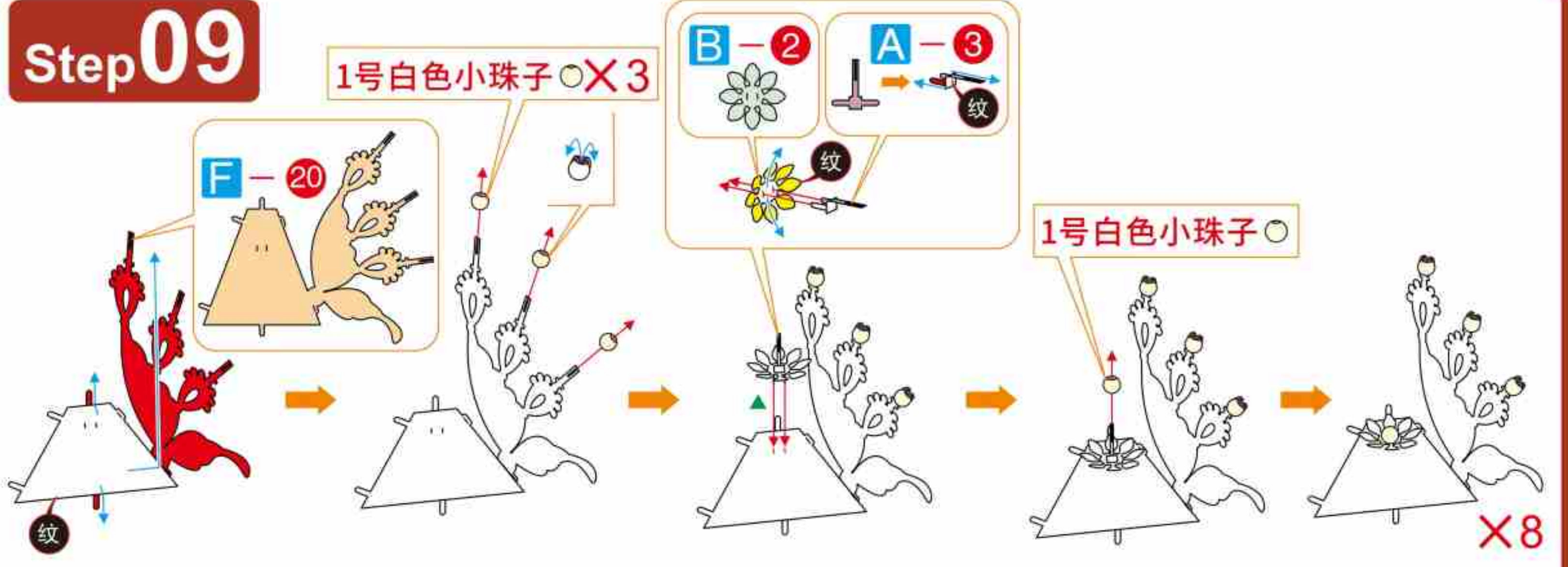

Step 10

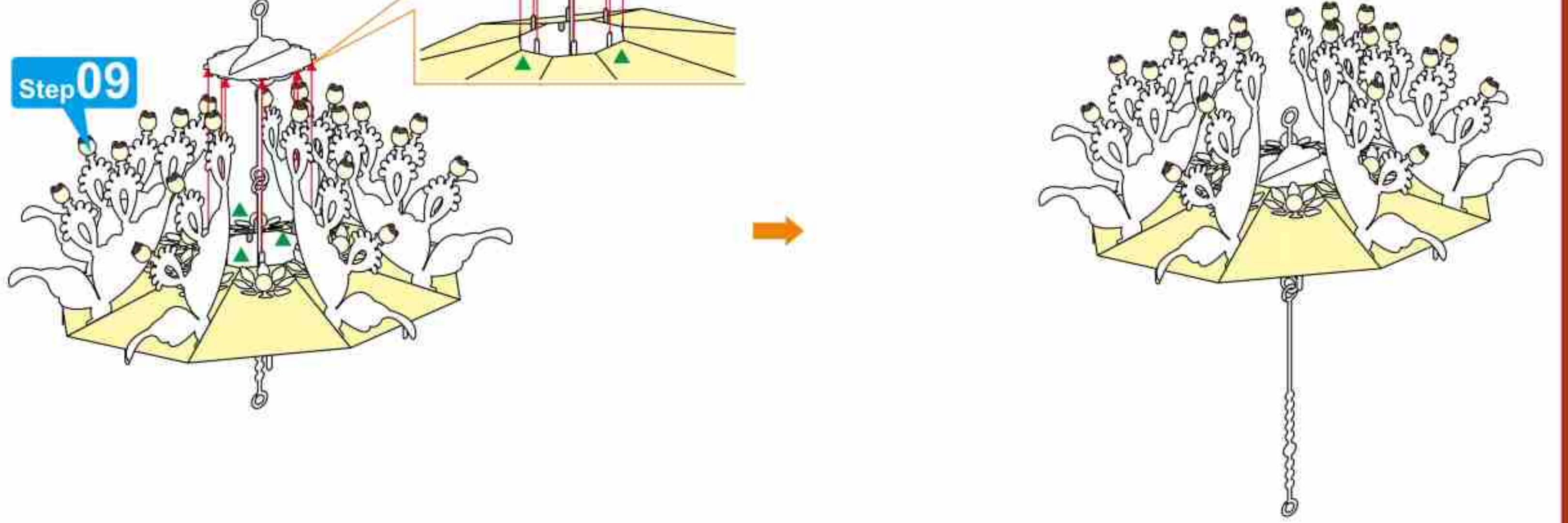
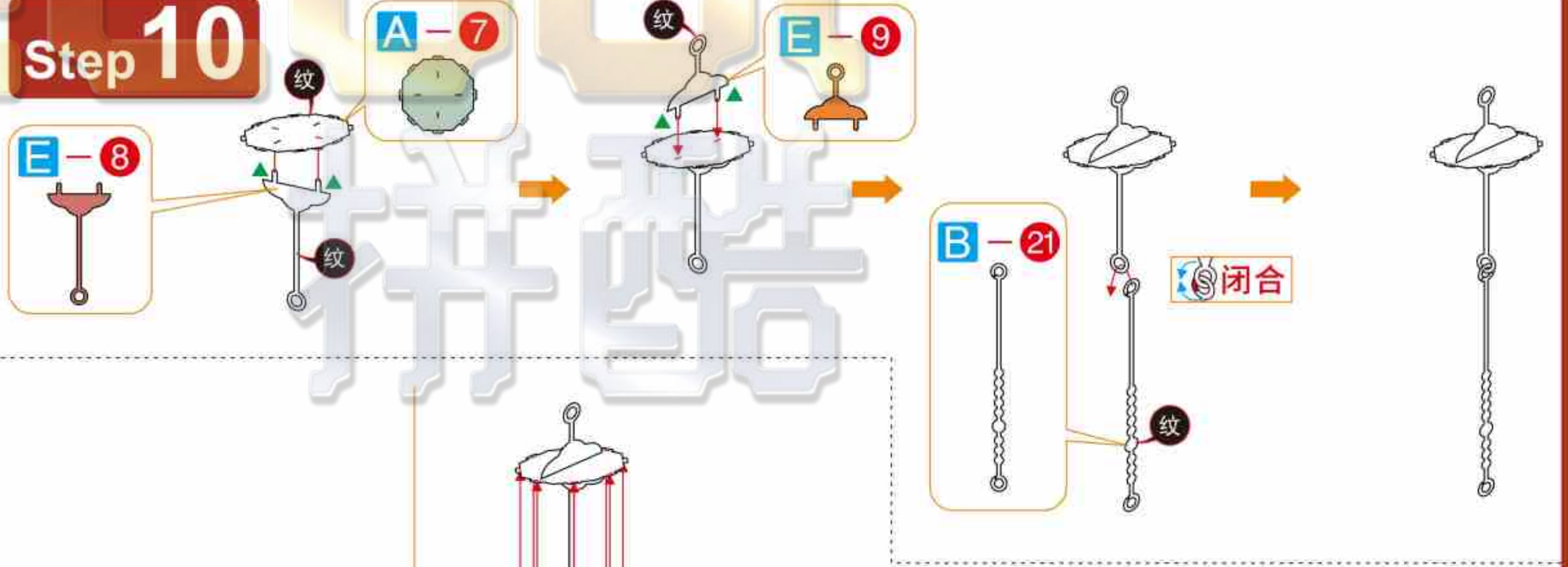

5 6  
7 8

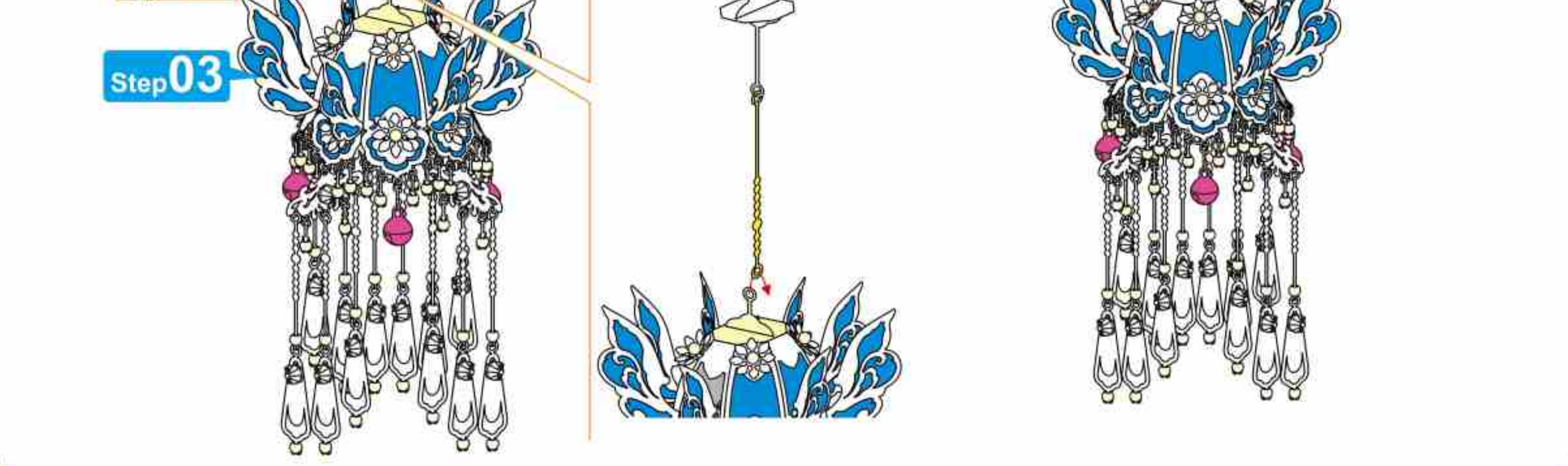
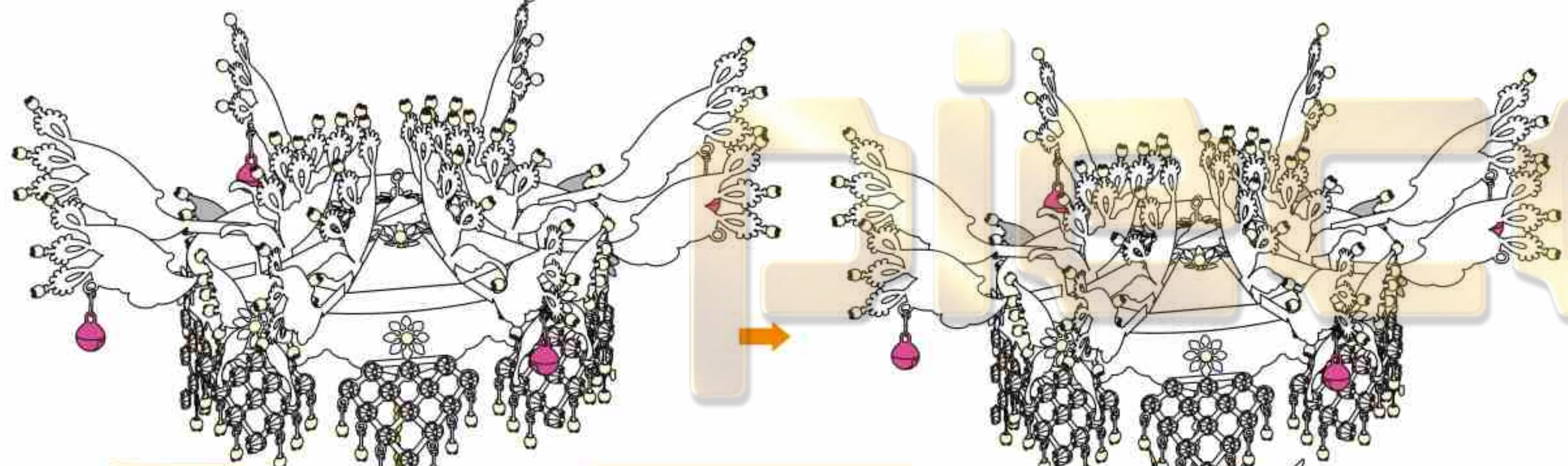
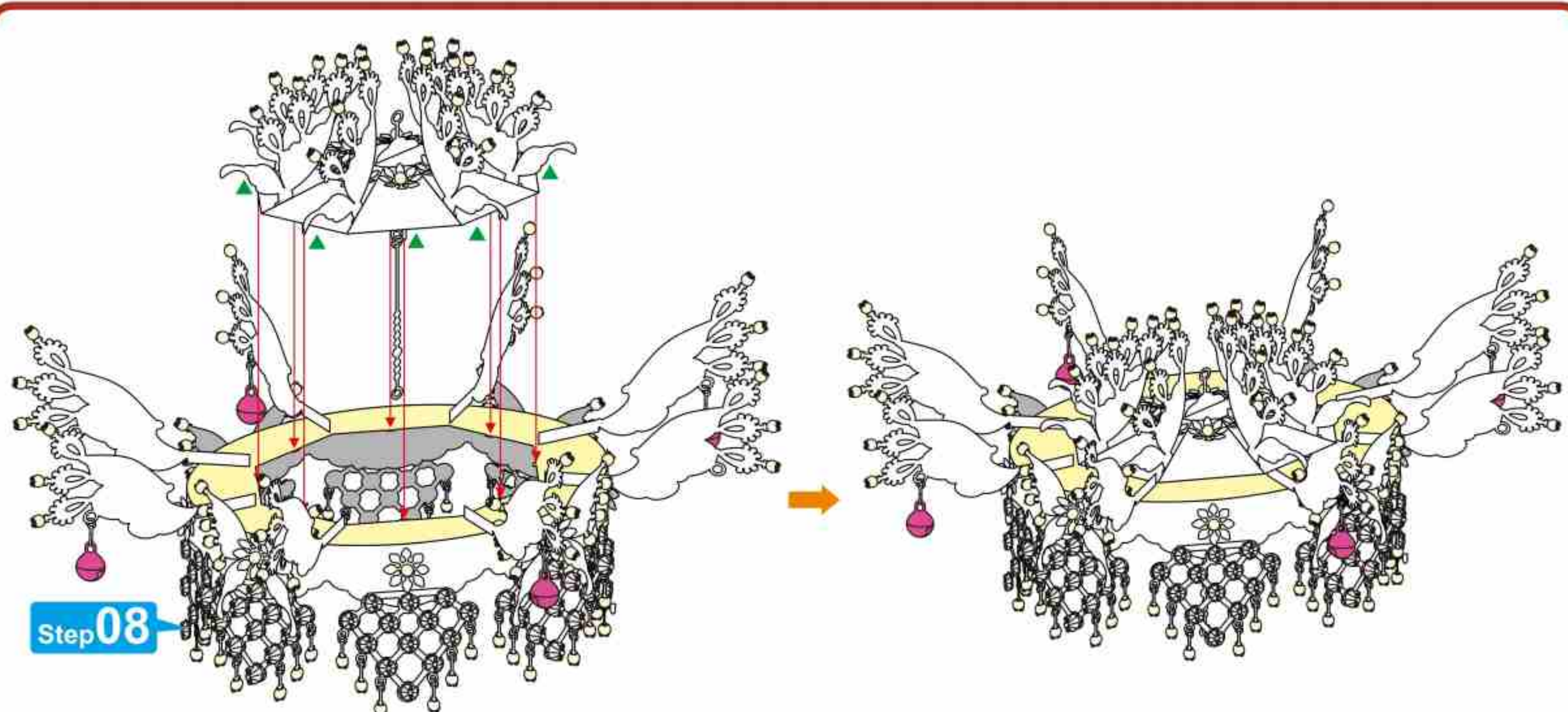

Step 12

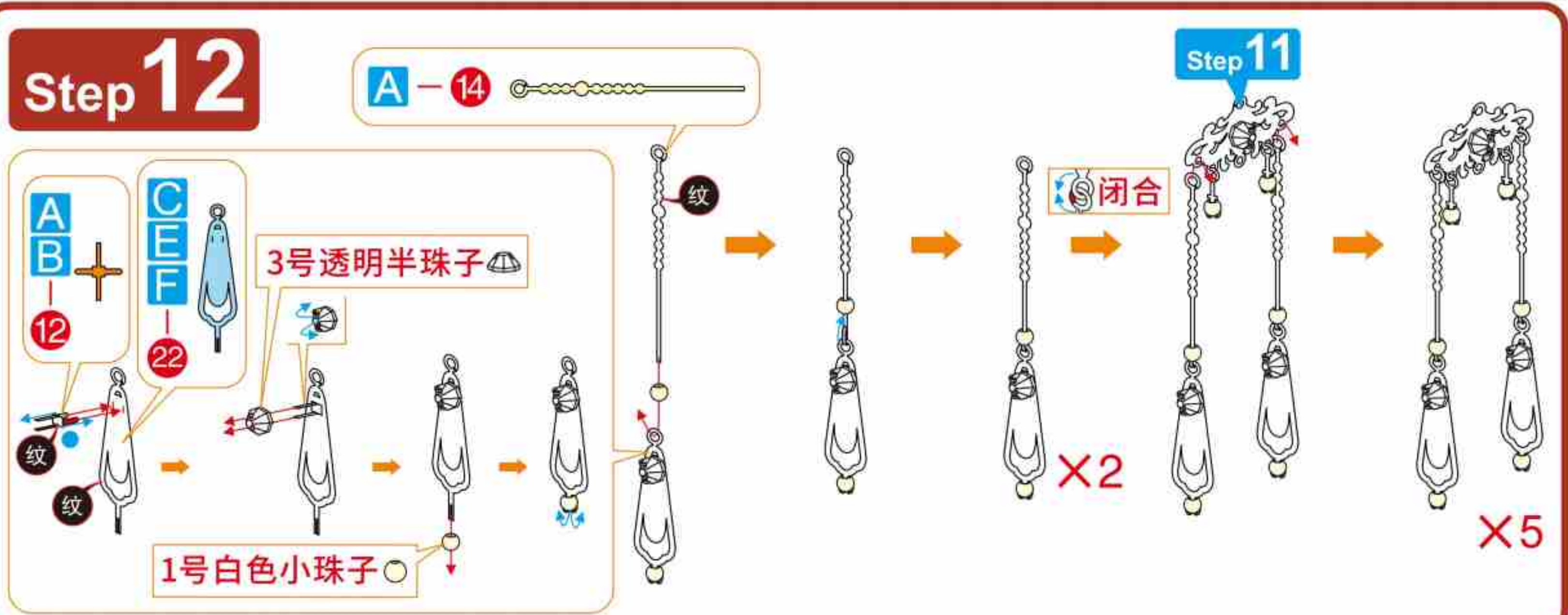

Step 13

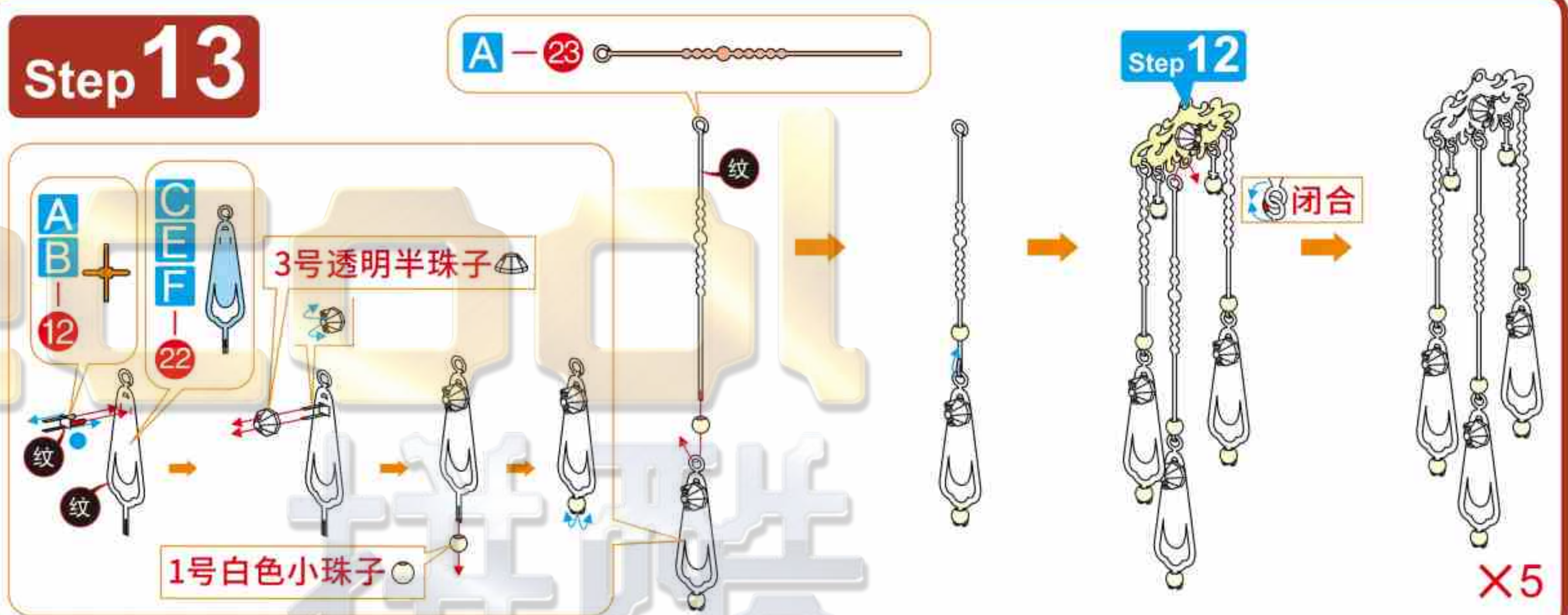

Step 14

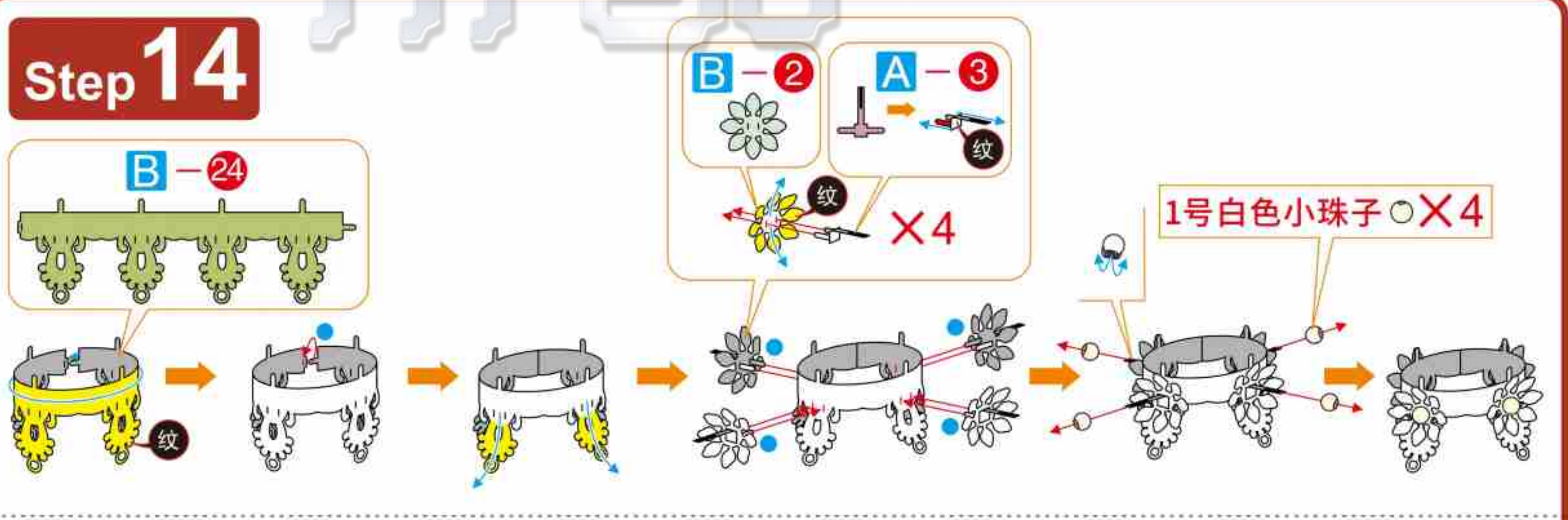

Step 11

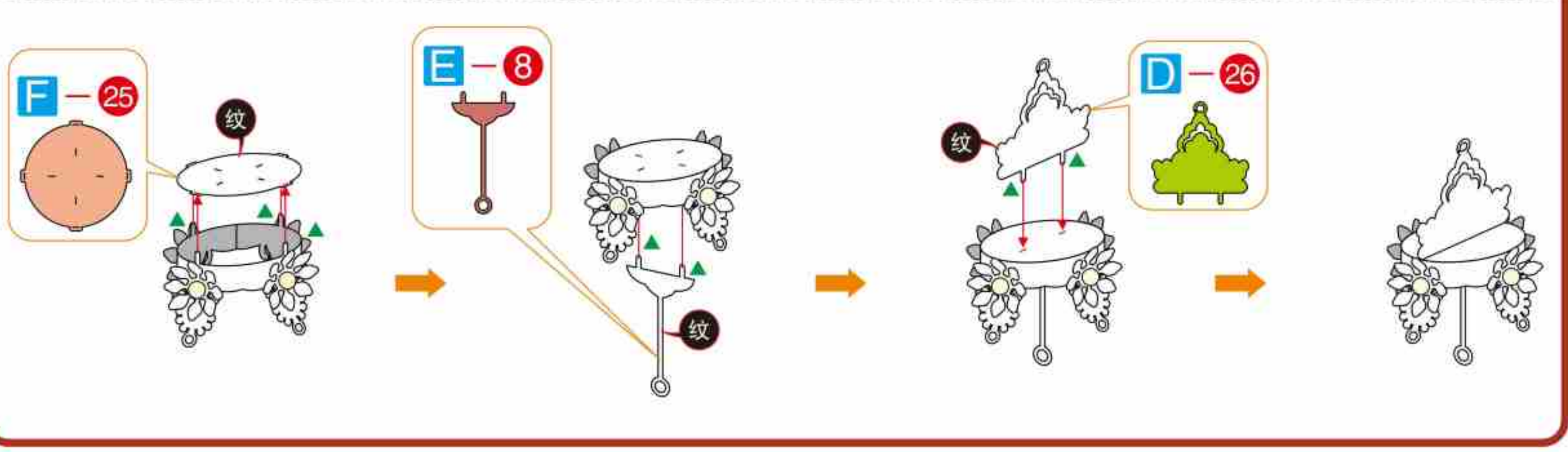
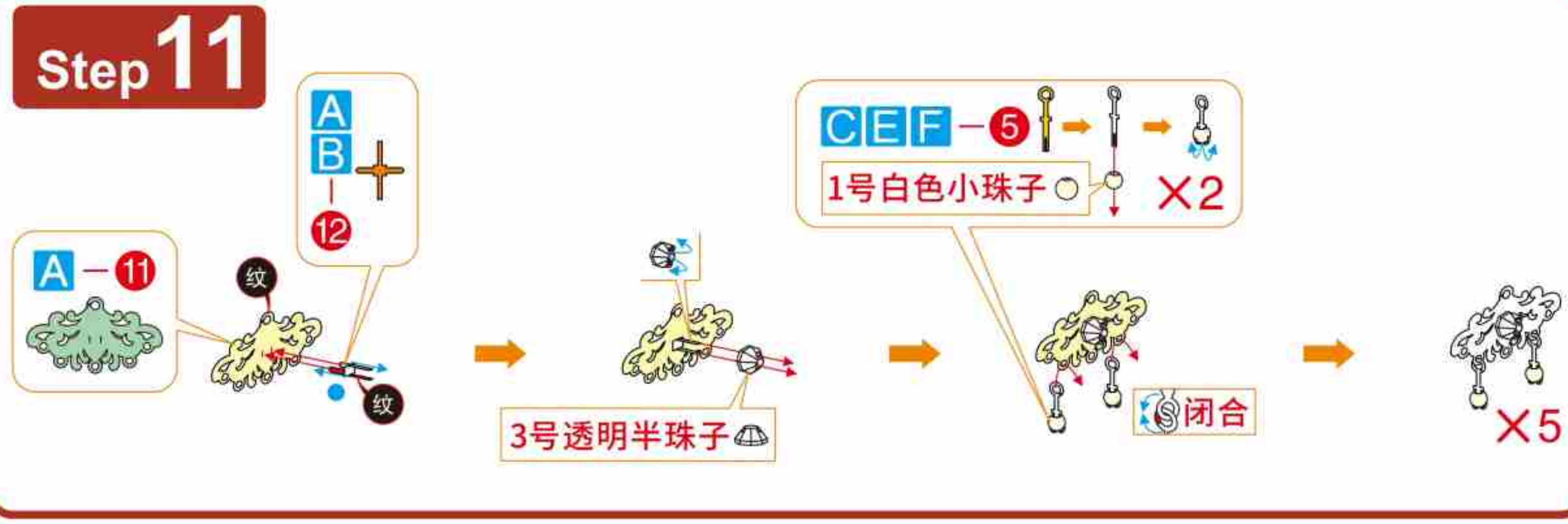



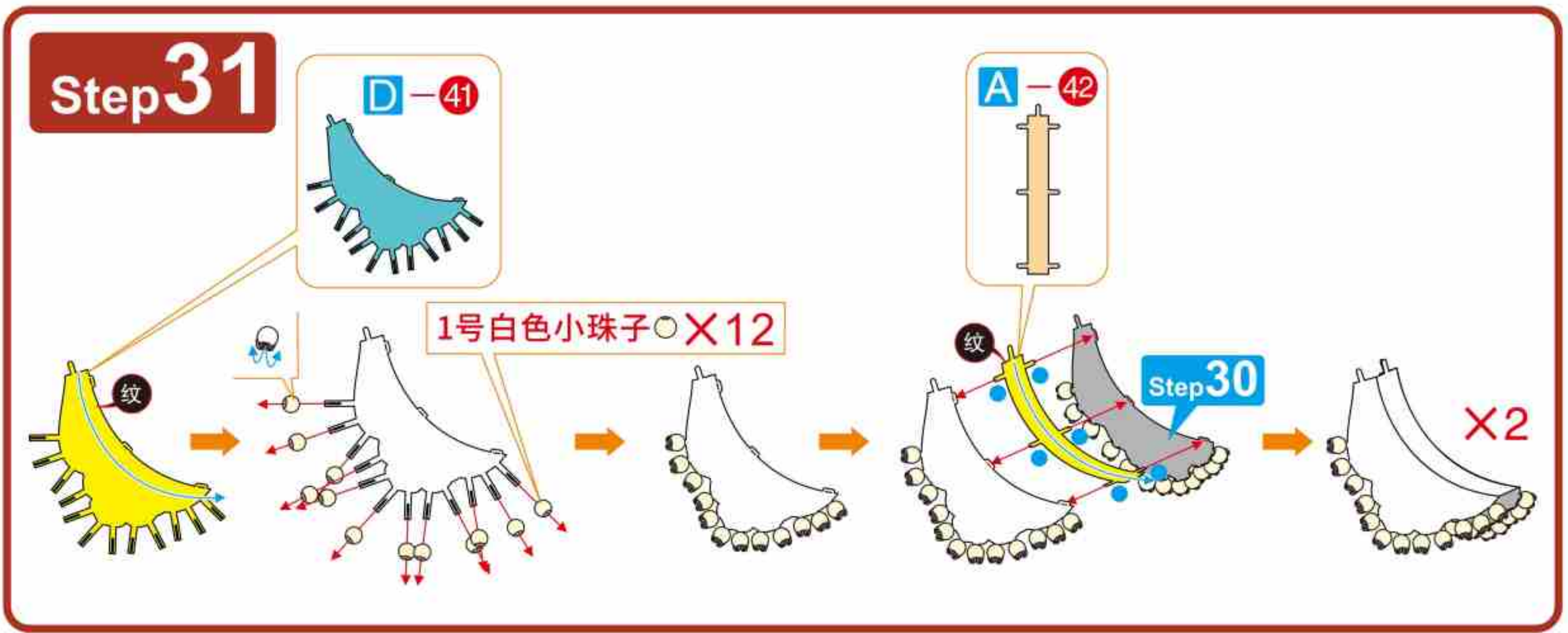
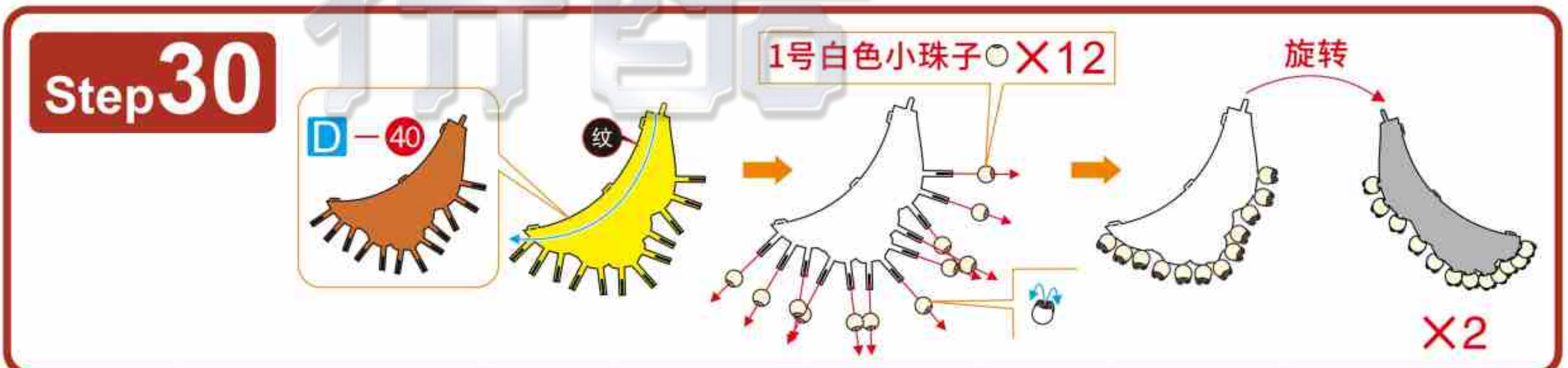
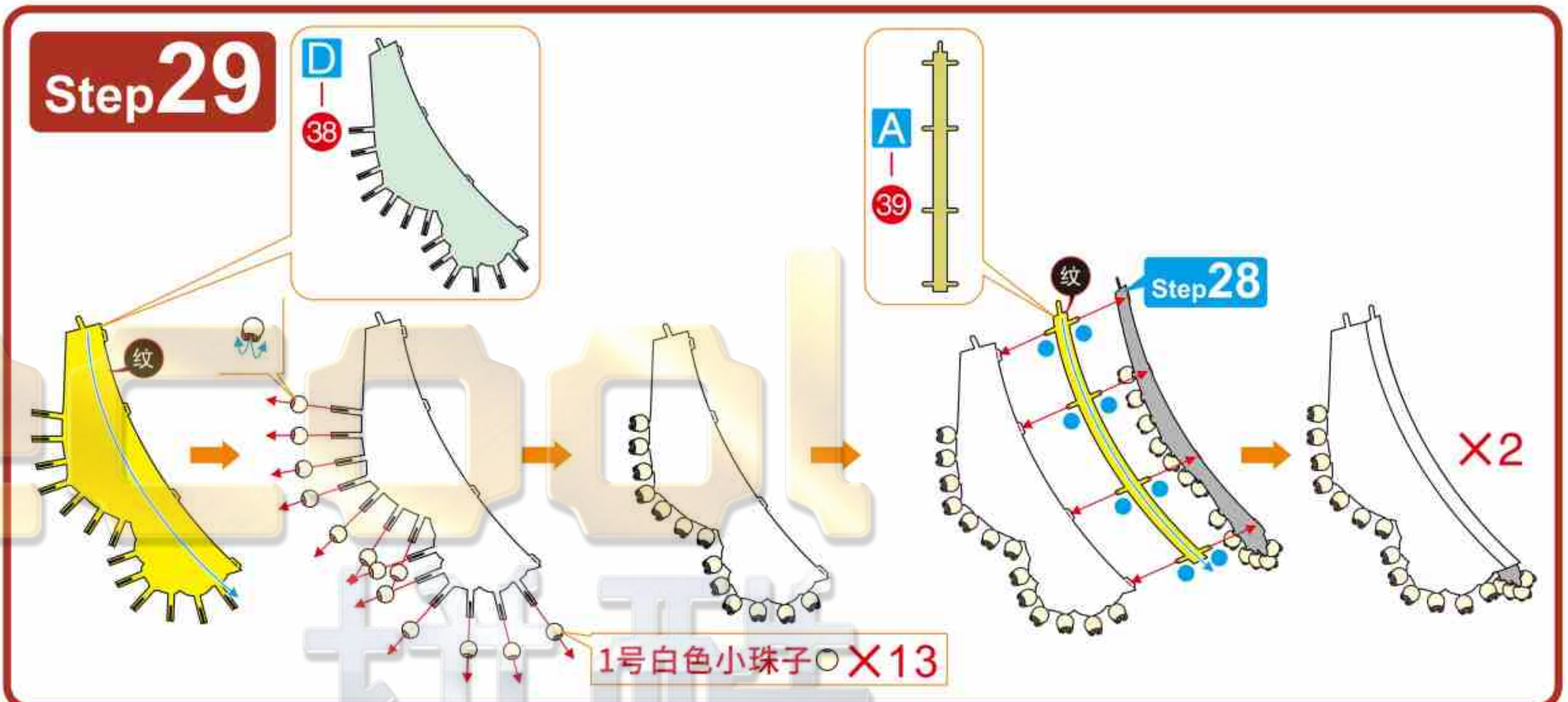
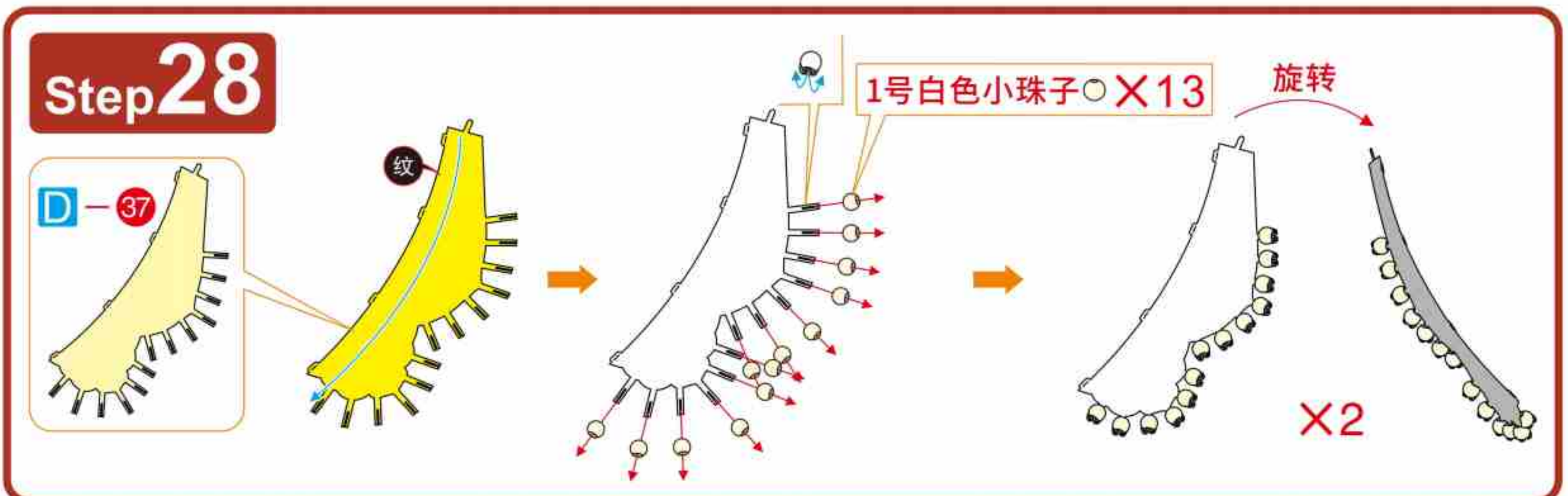
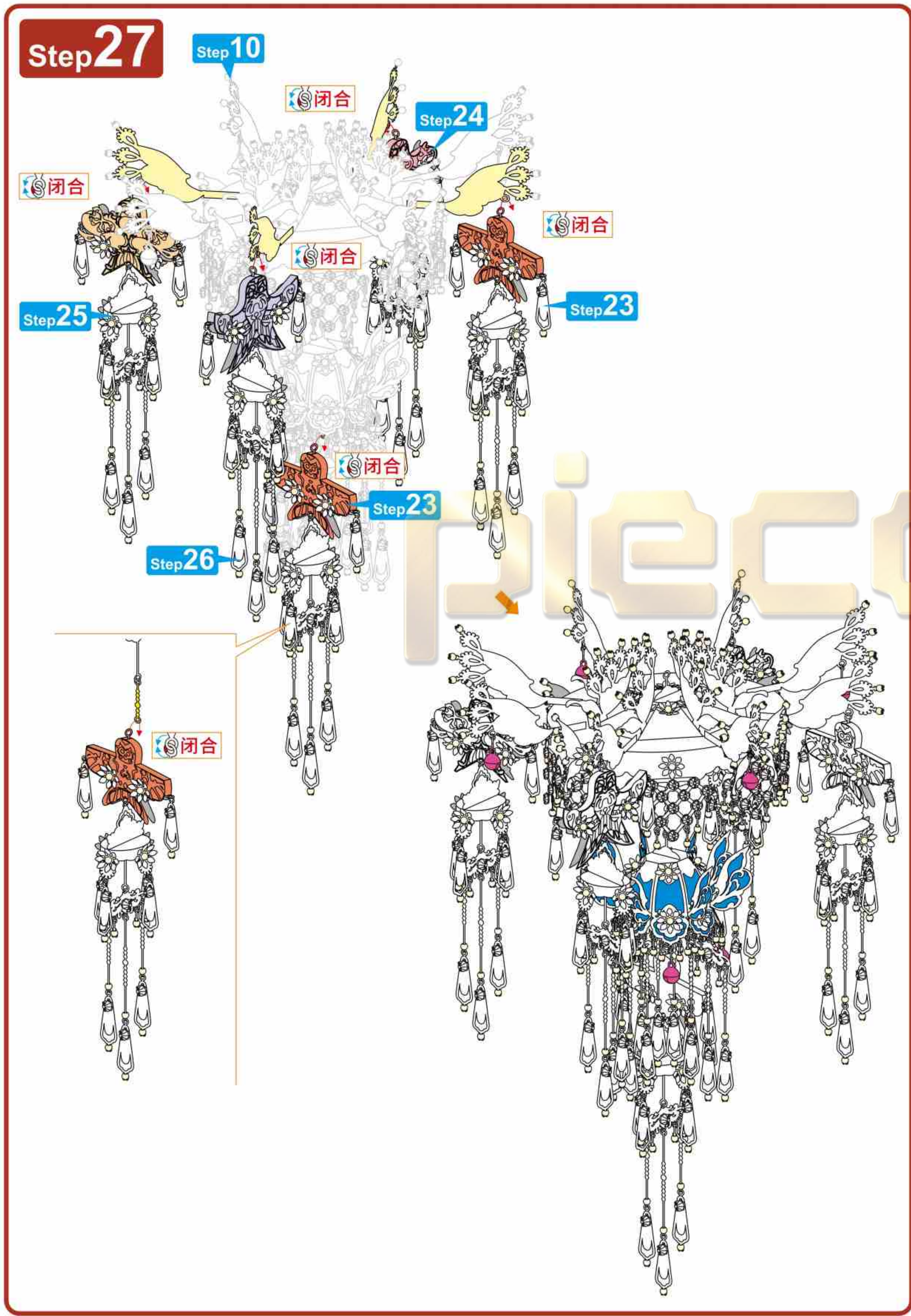
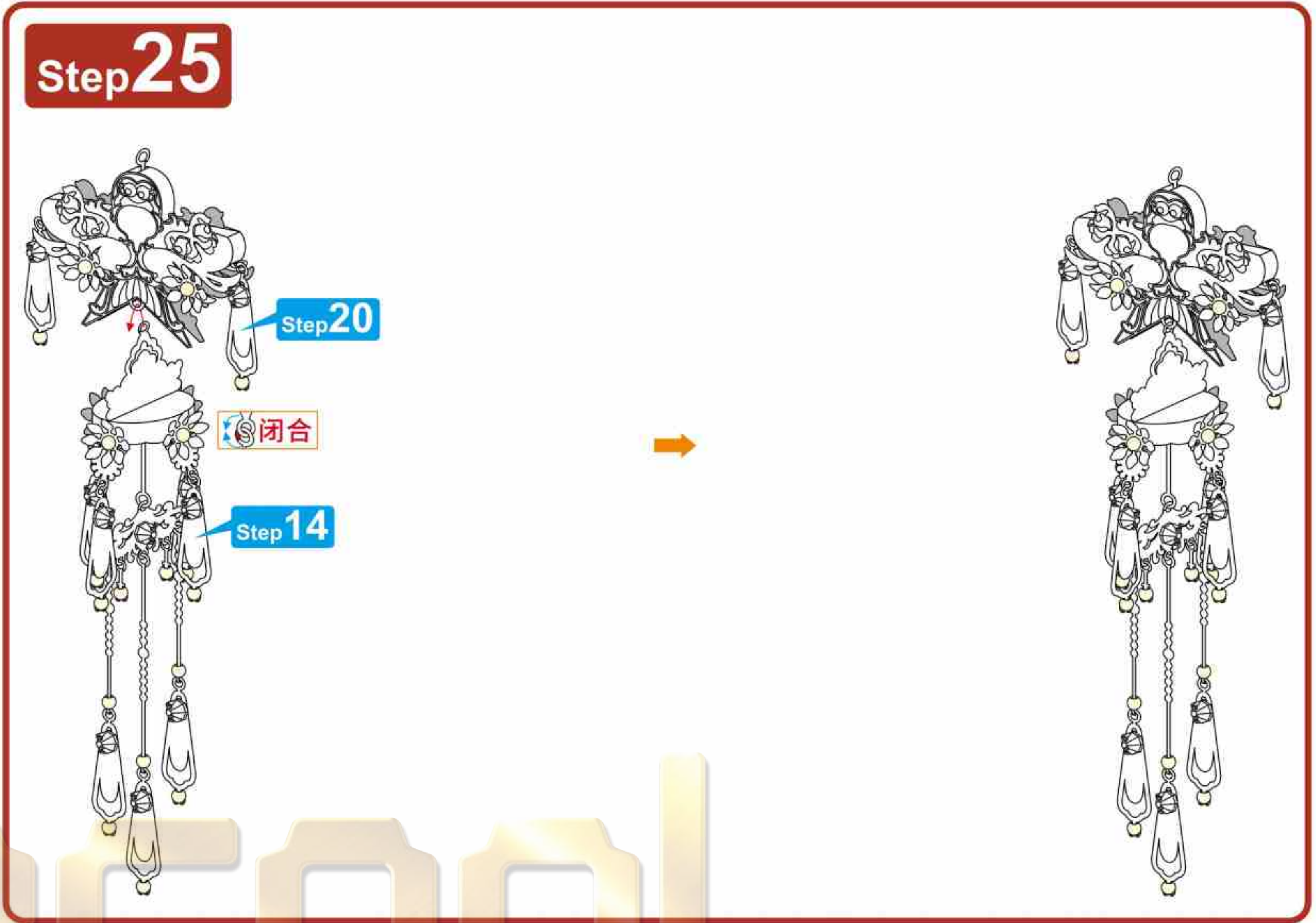
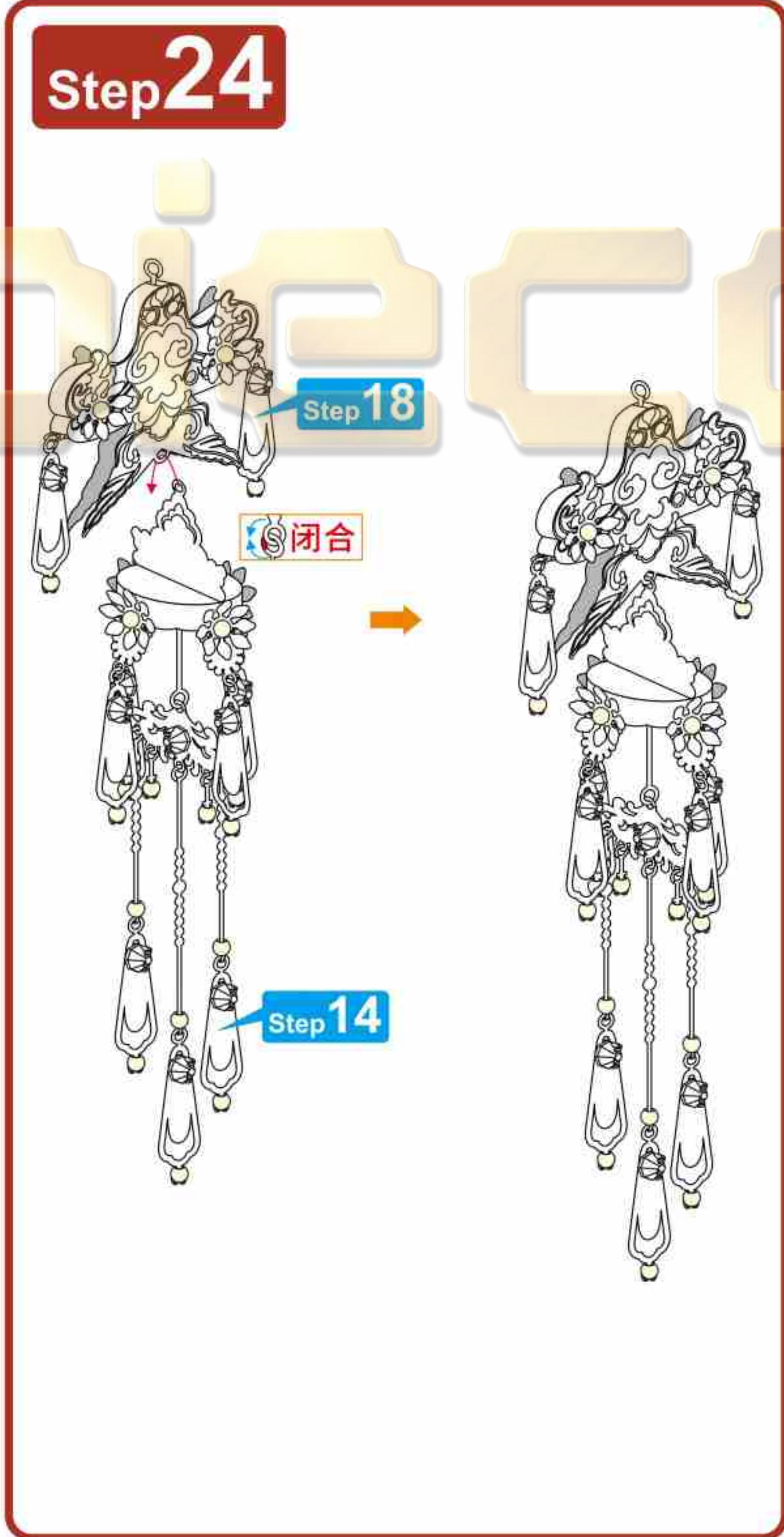
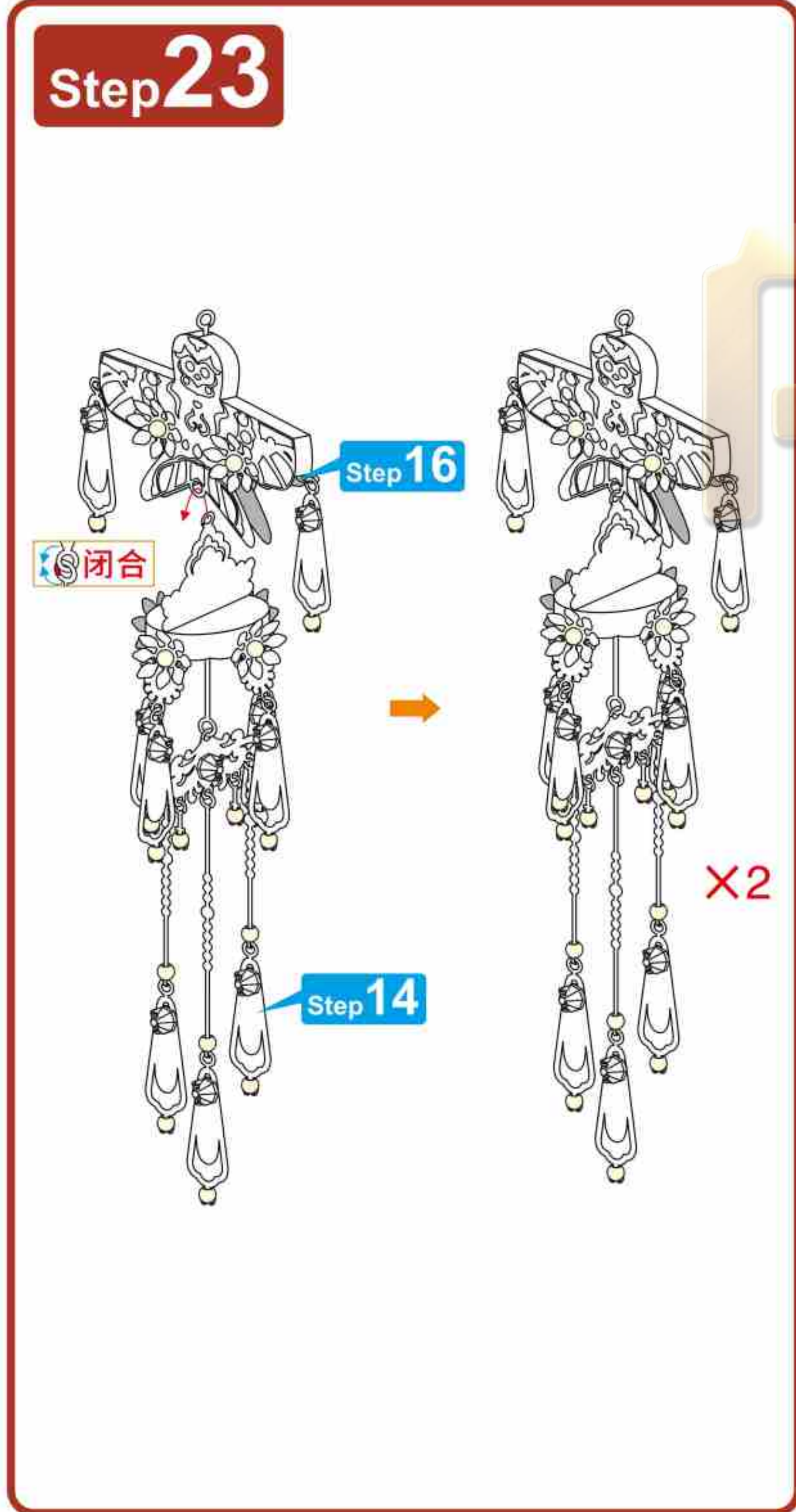
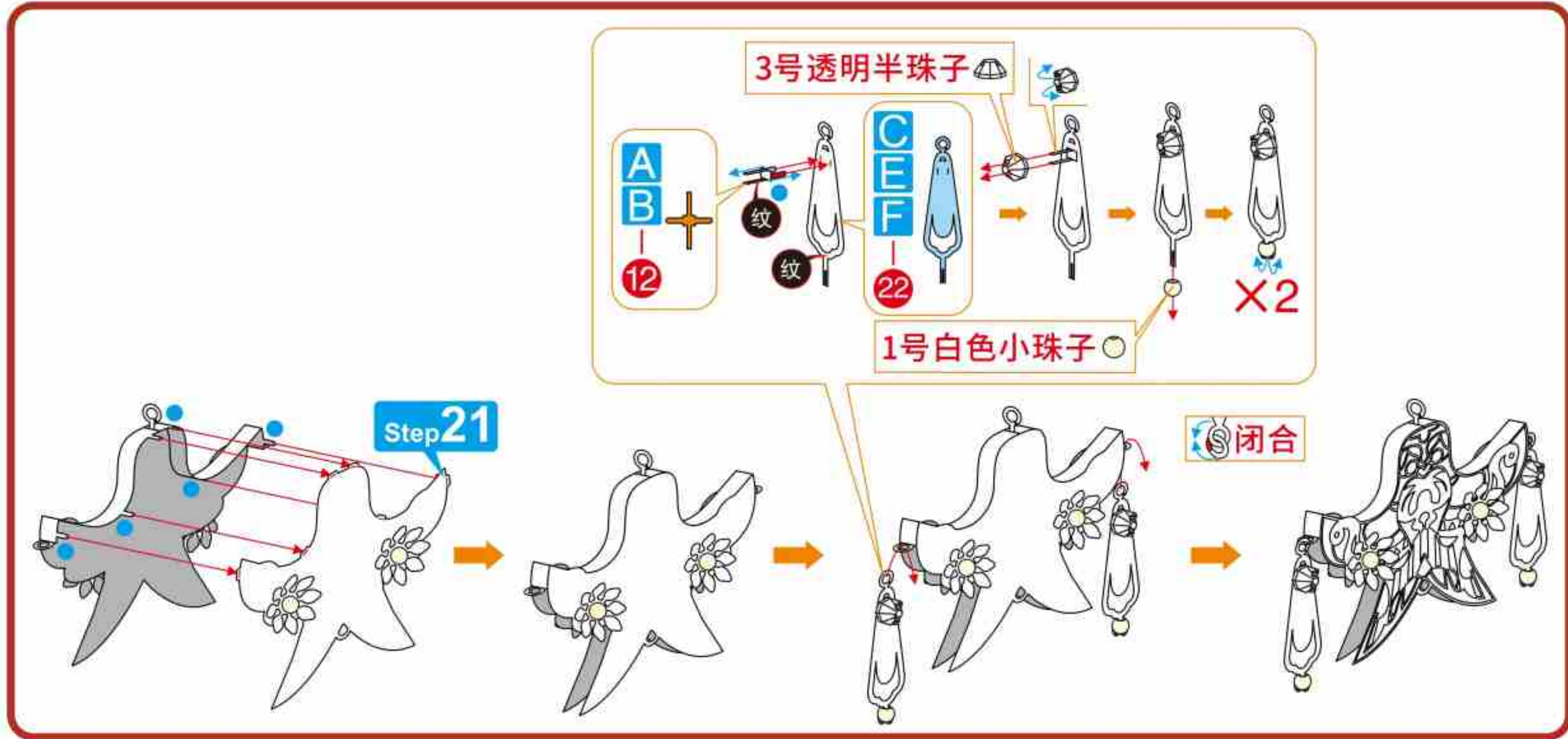

### Step 32

A-43  
Step 31  
Step 29

### Step 33

F-44  
3号透明半珠子  
1号白色小珠子  
闭合

### Step 34

D-45  
1号白色小珠子 X 15  
B-2  
A-3  
X 3

### Step 33

Step 33  
旋转

### Step 35

F-46  
3号透明半珠子  
1号白色小珠子  
闭合

### Step 36

D-47  
B-2  
A-3  
X 3  
1号白色小珠子 X 15

### Step 35

1号白色小珠子 X 3  
Step 35

17 18  
19 20

### Step 37

A-48  
E-9  
X 2

### Step 36

Step 34  
X 2

### Step 39

Step 32  
Step 37  
Step 38  
闭合

### Step 38

A-49  
X 2

### Step 38

F-25  
E-8  
E-50  
3号透明半珠子  
1号白色小珠子  
闭合

### Step 40

D-51  
B-2  
A-3  
C-52  
1号白色小珠子  
旋转

### Step 41

D-53  
1号白色小珠子  
B-2  
A-3  
C-54  
Step 40

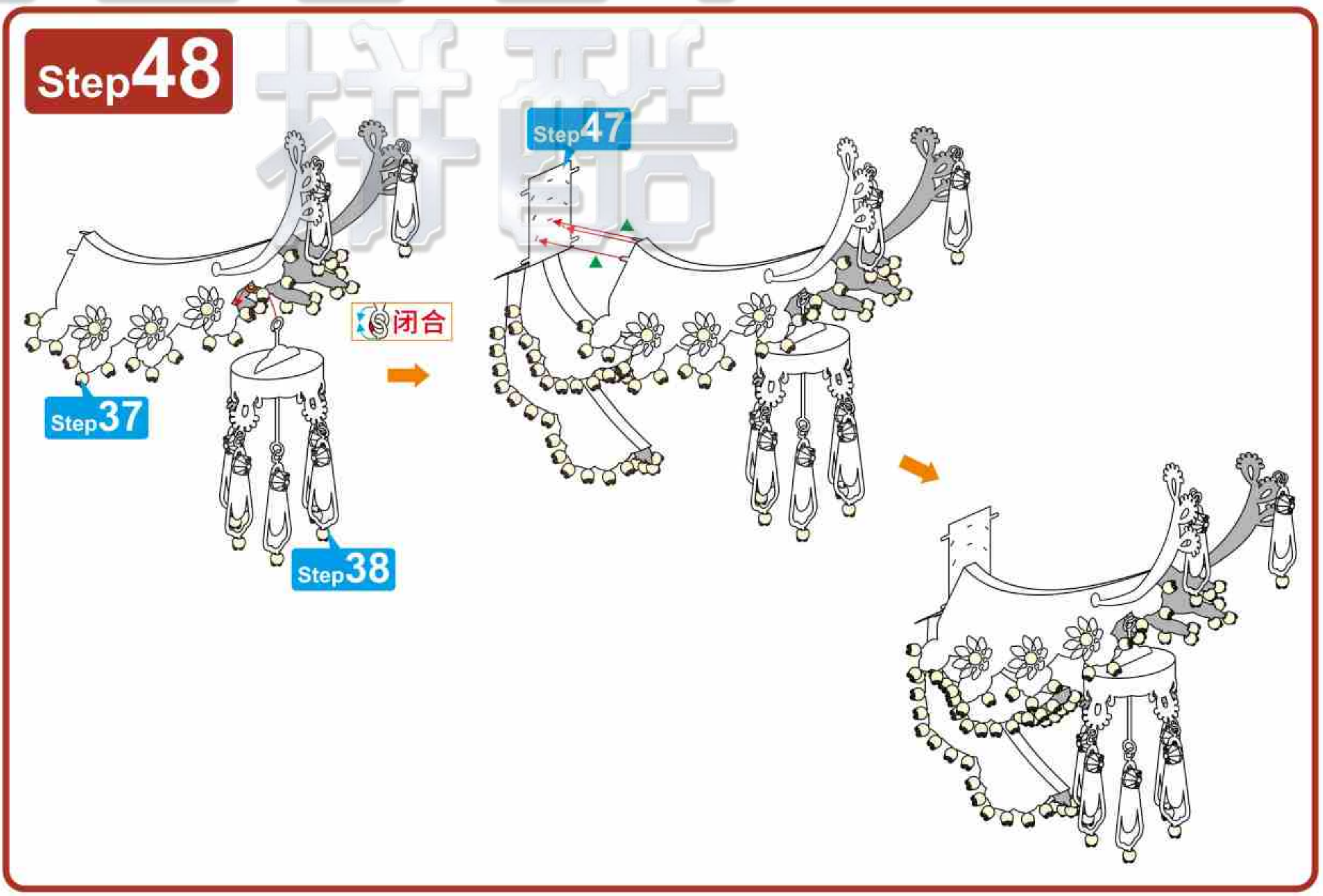
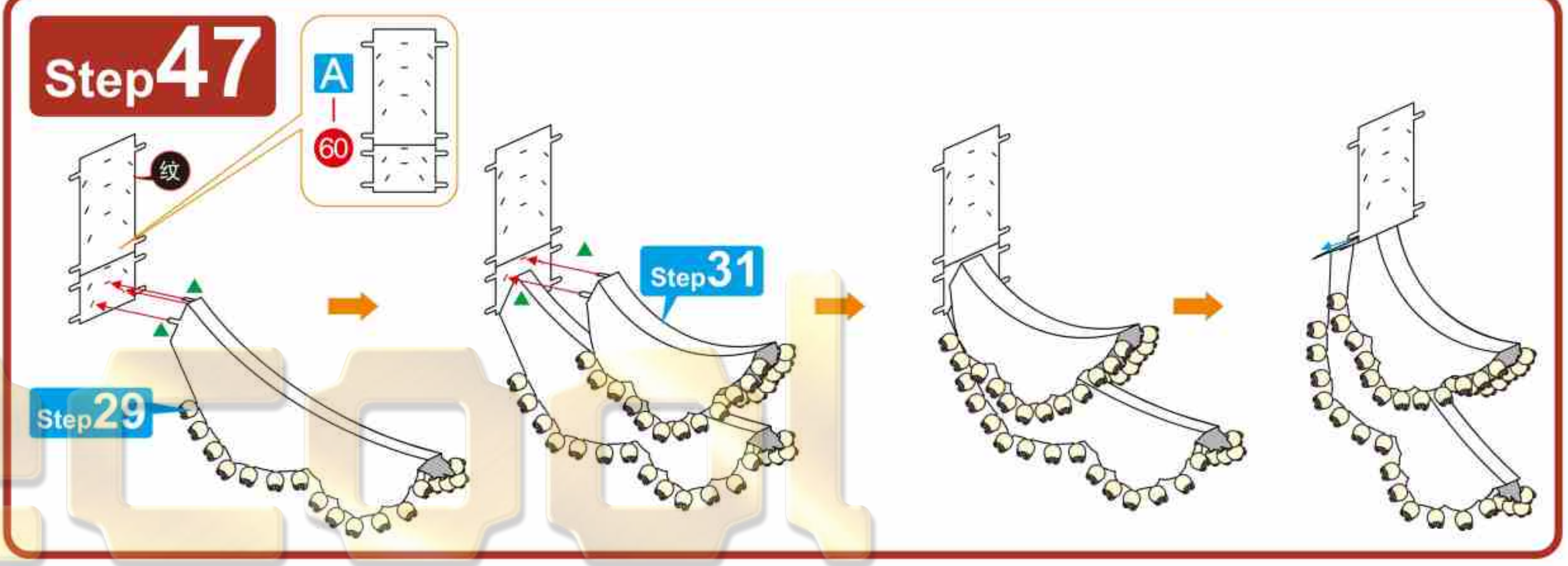
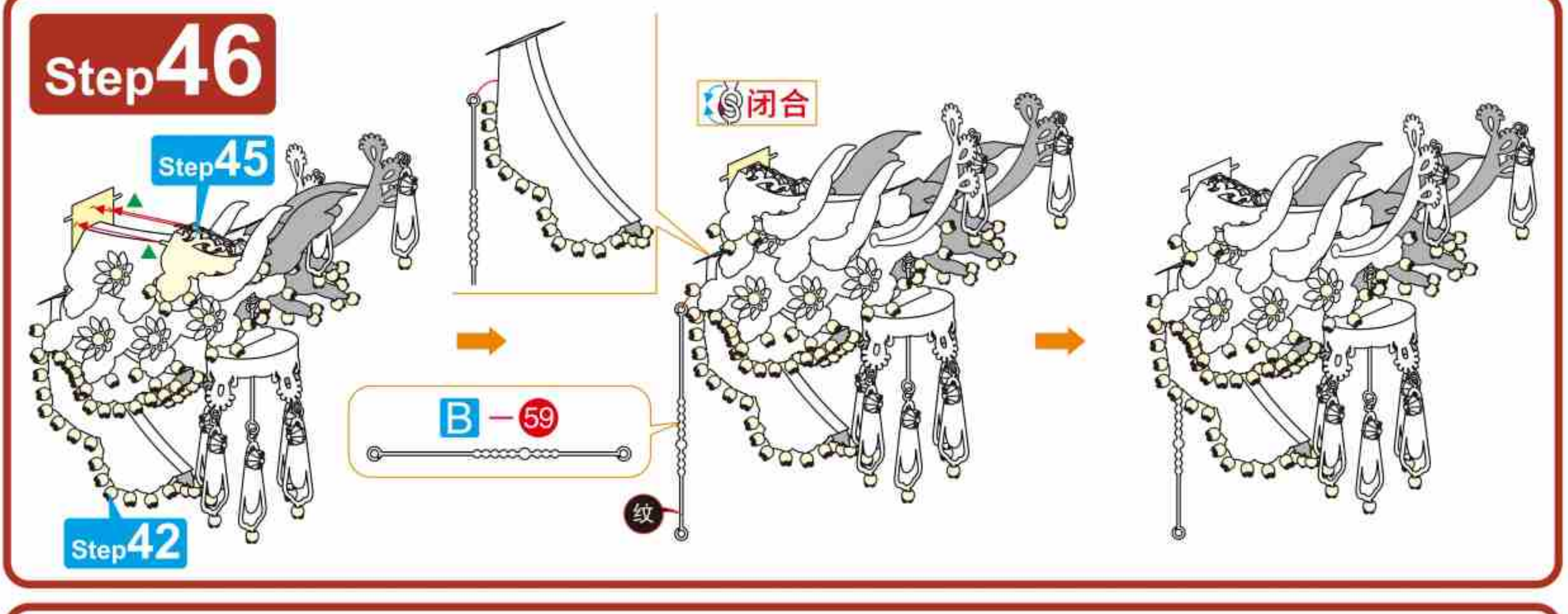
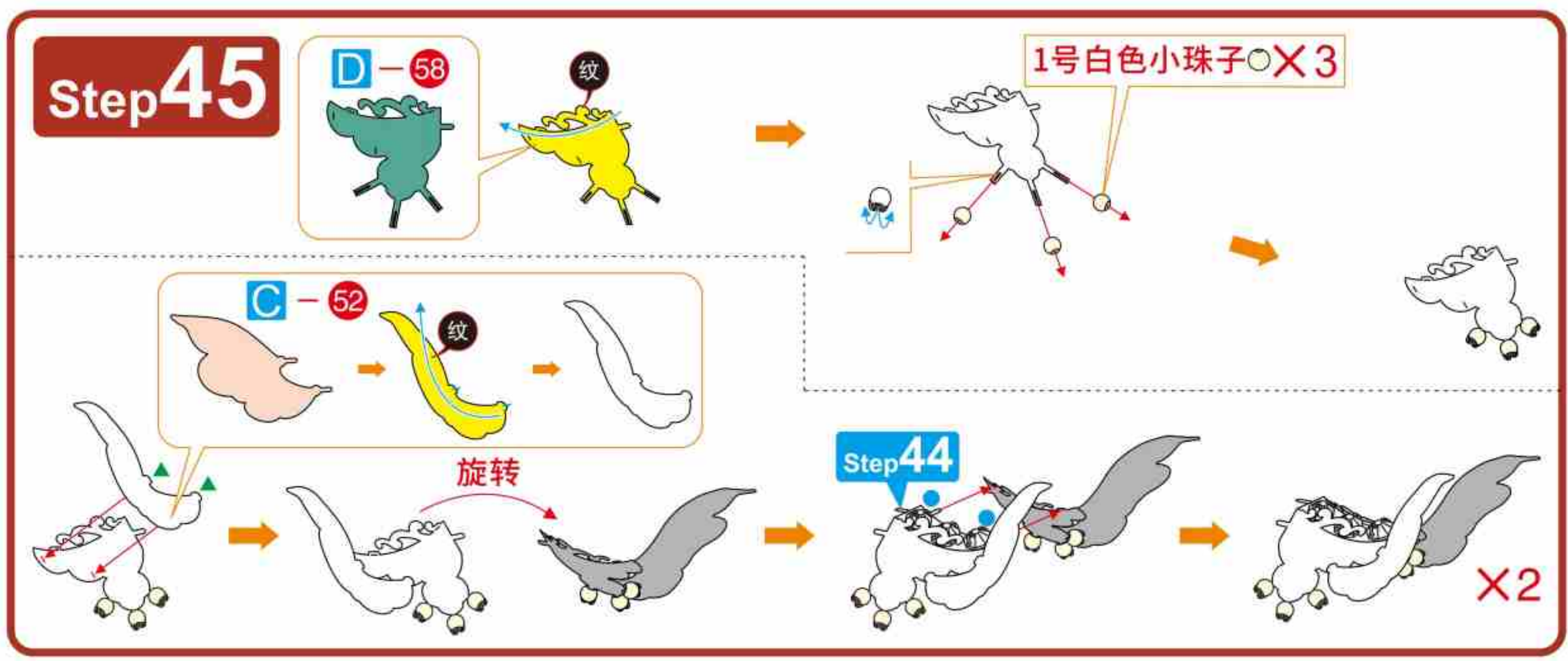
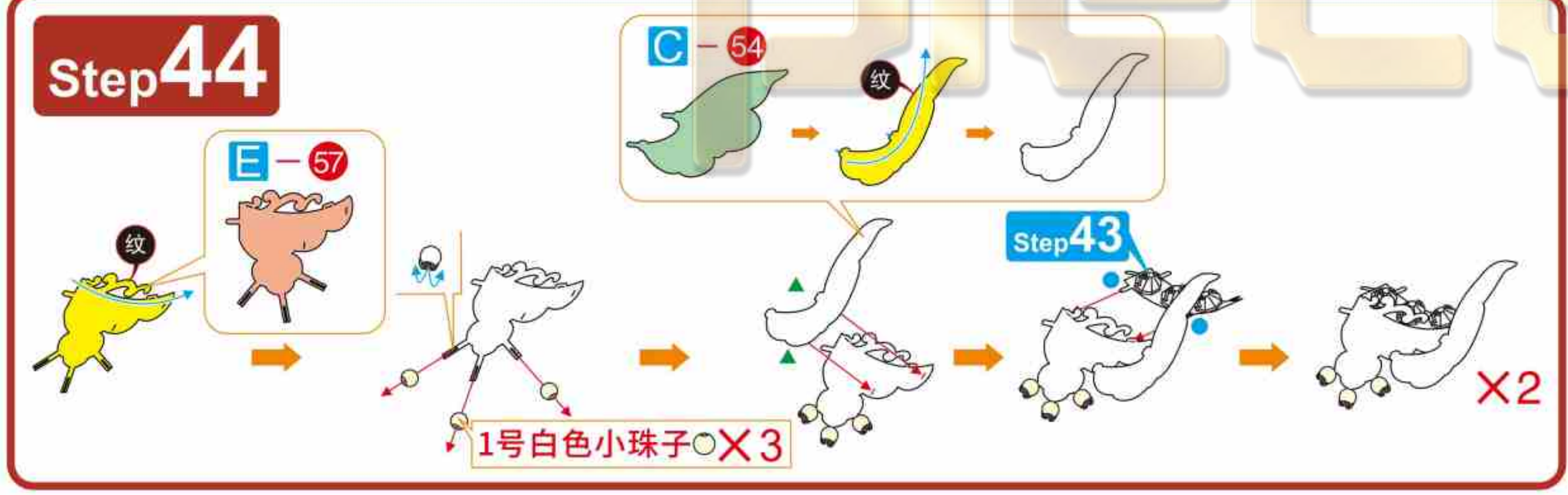
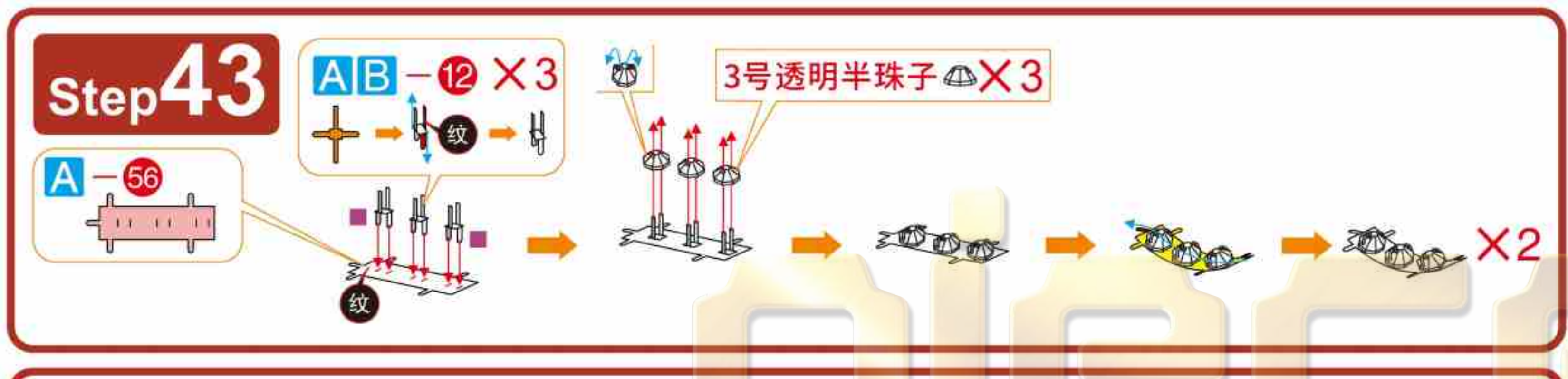
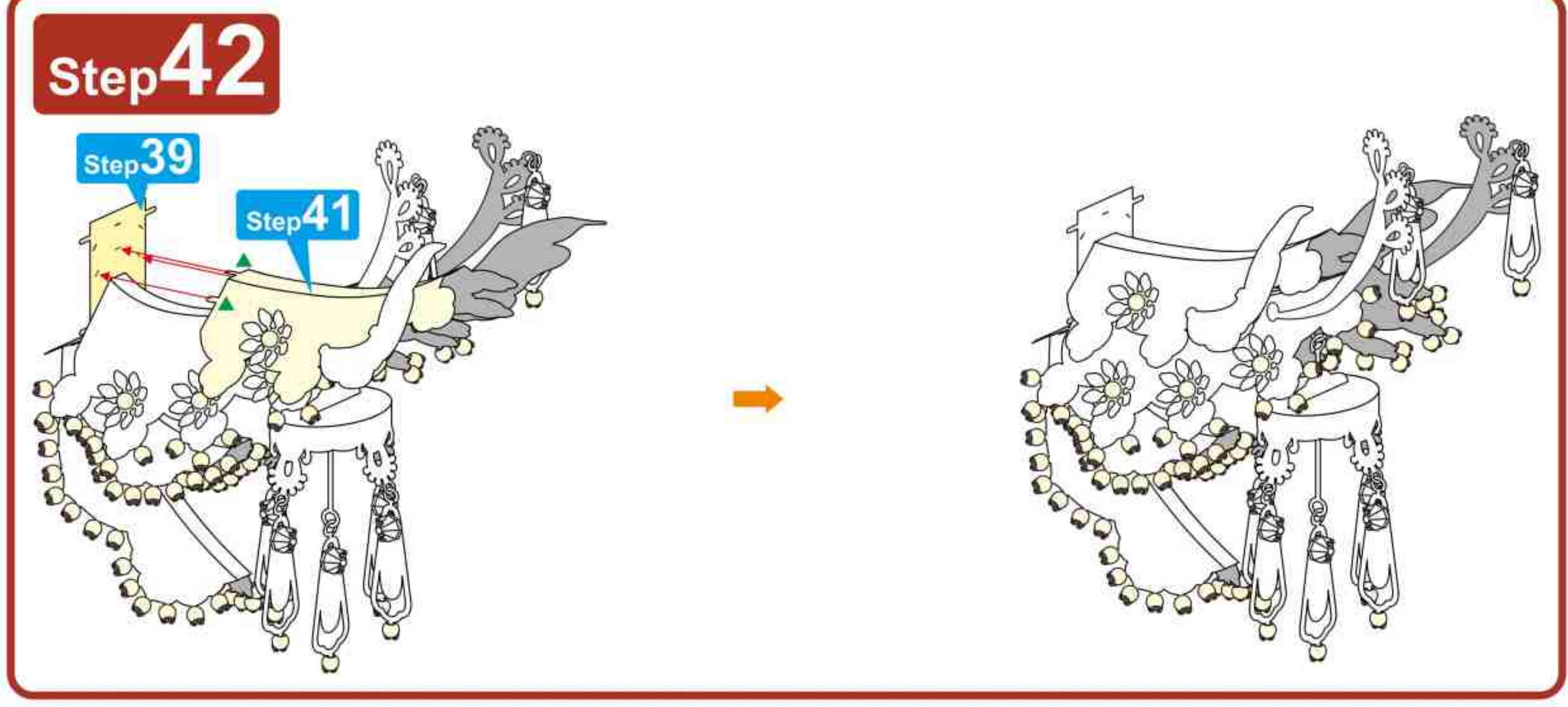

21 22  
23 24

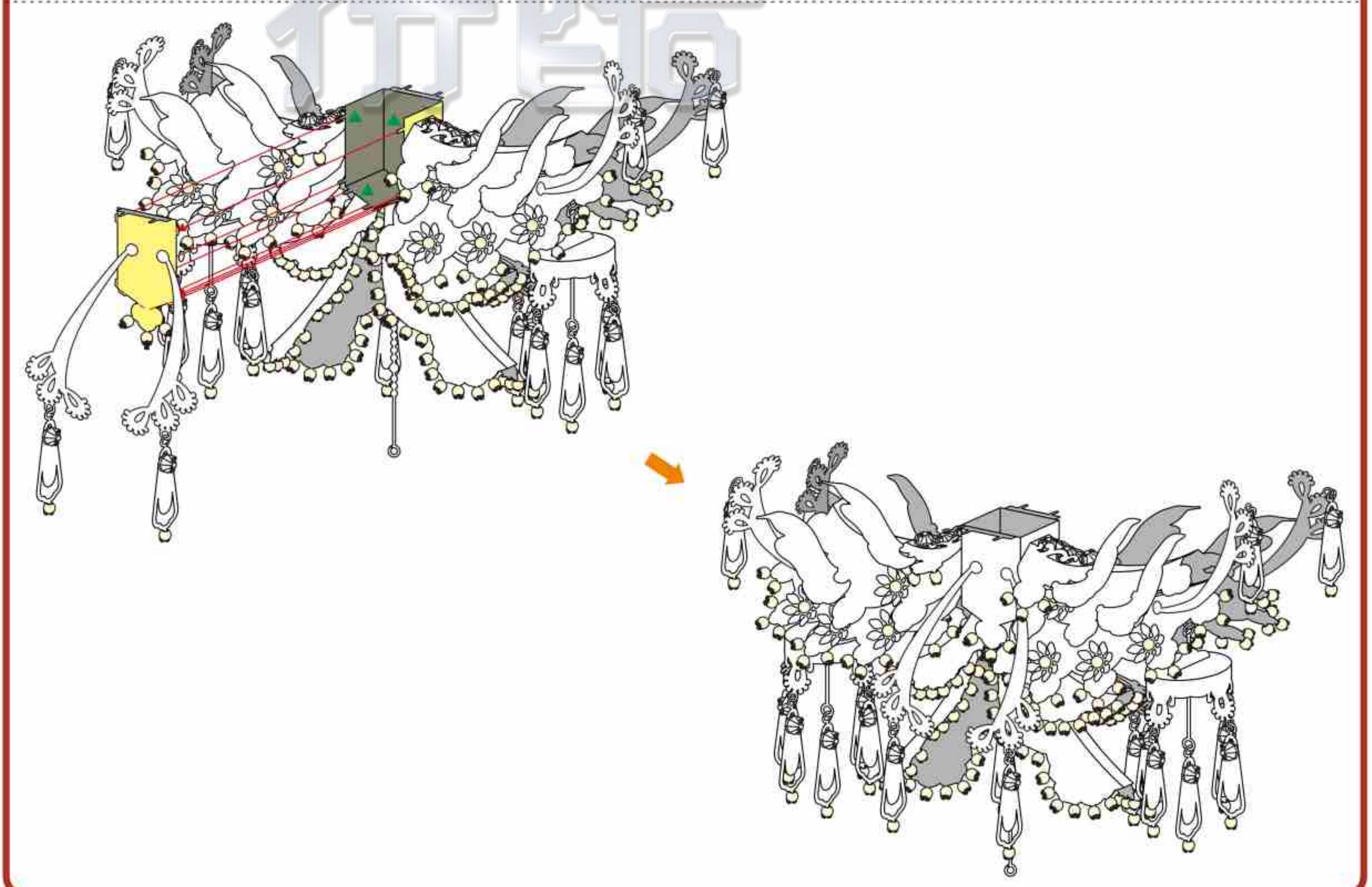
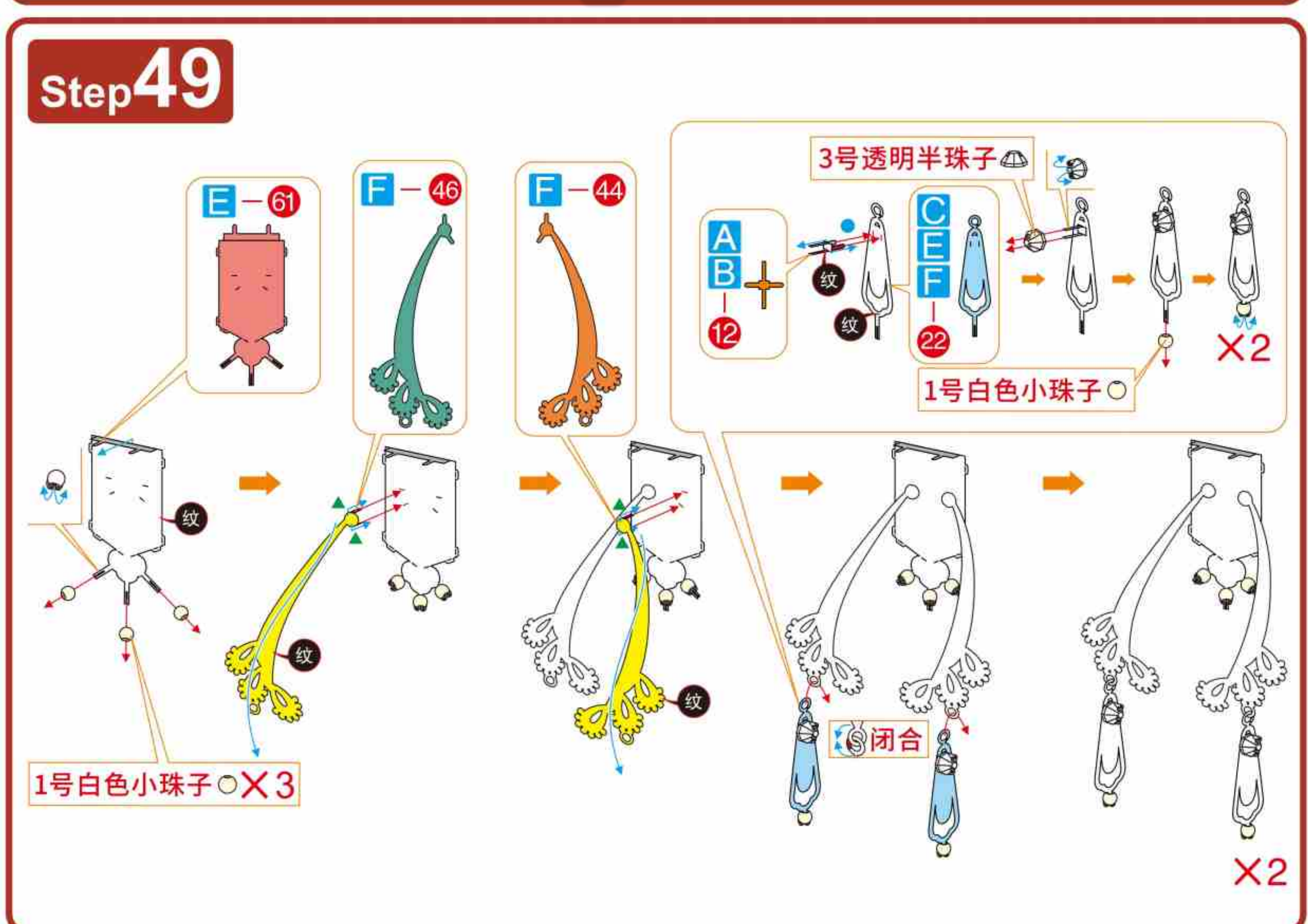
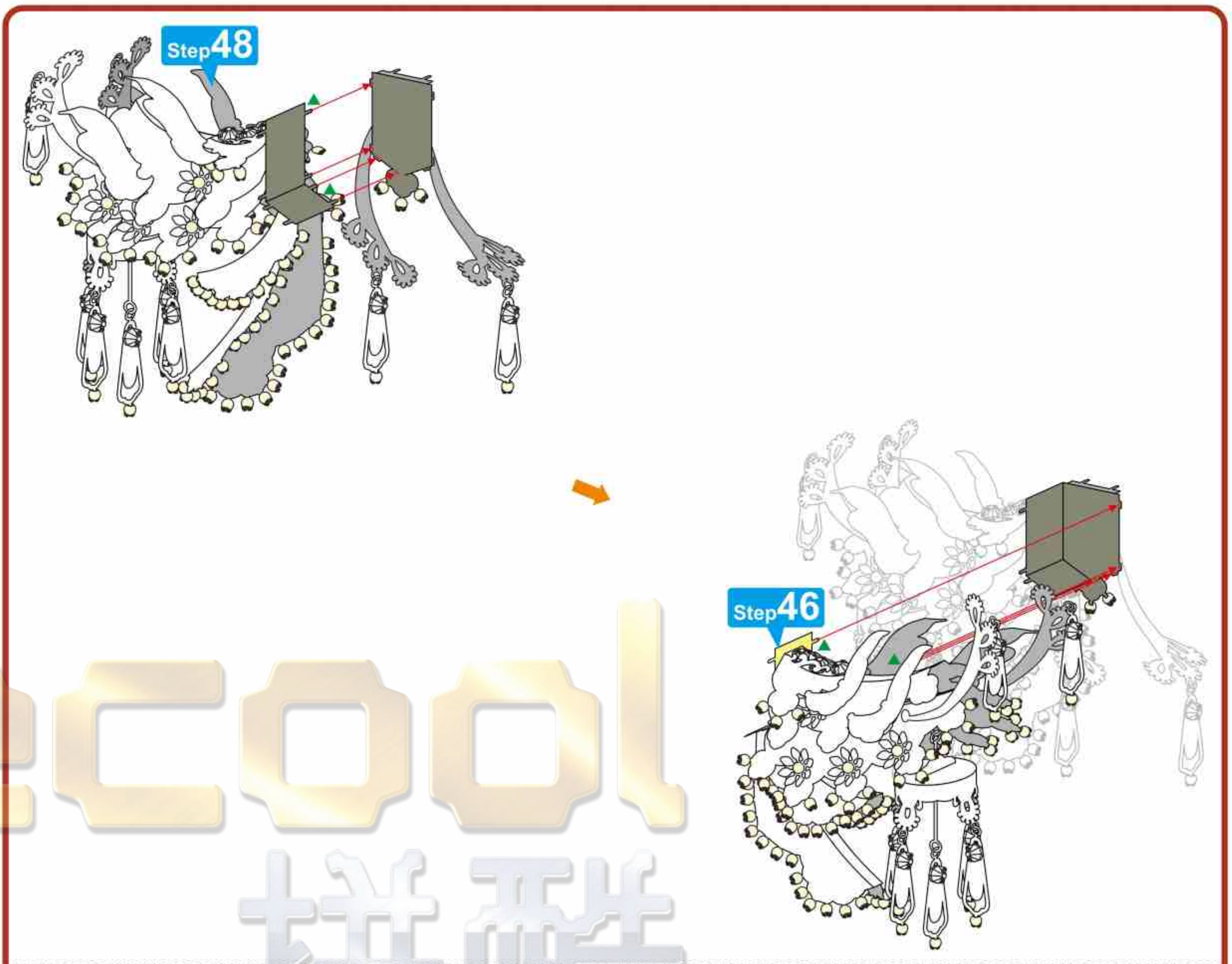
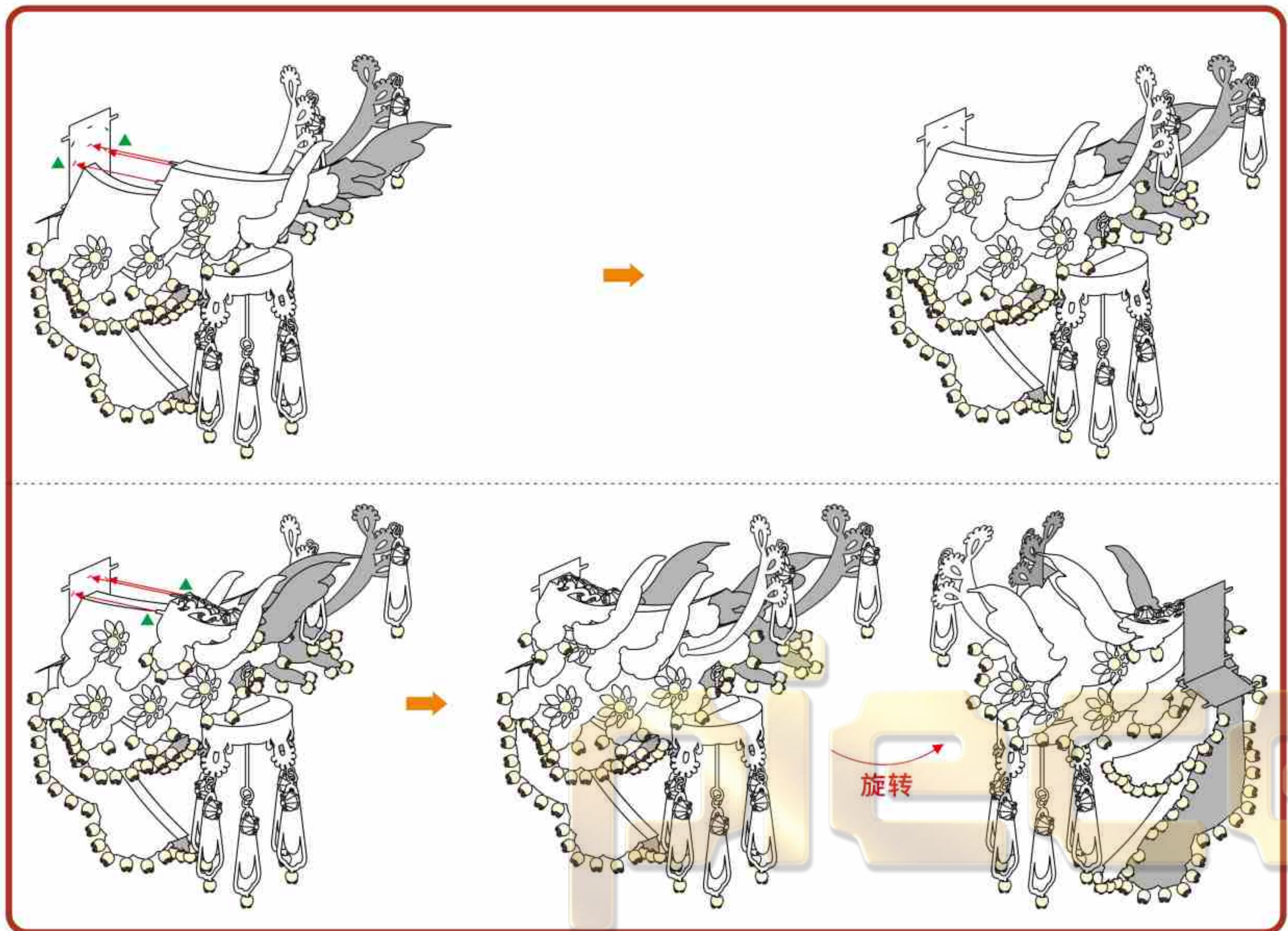

**Step 50**

AB-12 X 3

3号透明半珠子 X 3

A-62

**Step 51**

AB-12 X 3

3号透明半珠子 X 3

A-63

旋转

**Step 52**

E-64

B-2

A-3

1号白色小珠子 X 9

1号白色小珠子

A-65

A-66

A-67

X 2

**Step 53**

Step 51

Step 52

Step 50

**Step 49**

**Step 52**

68

闭合

闭合

**Step 27**

piececool  
拼酷