

骑士熊  
KNIGHT  
P210

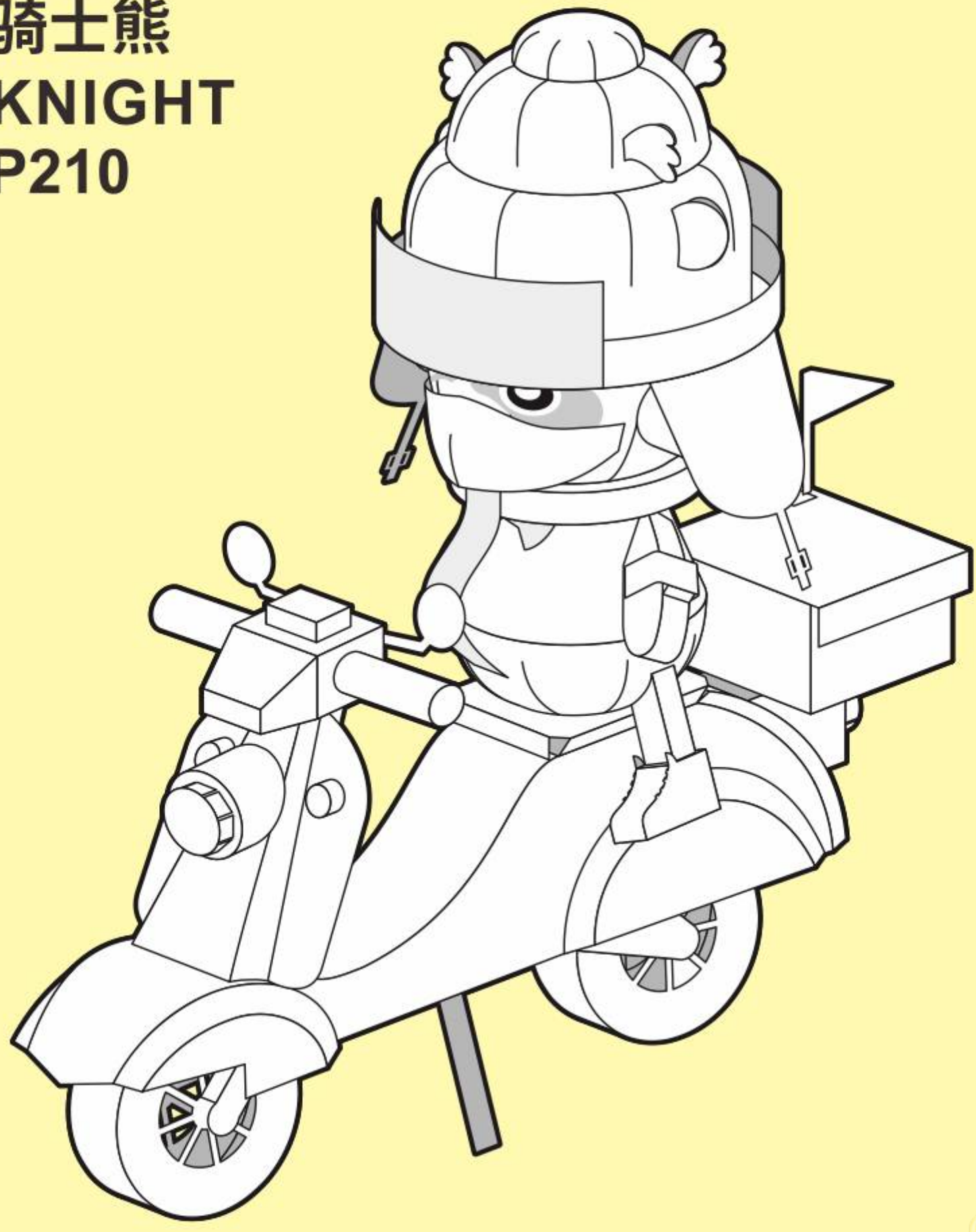

CP-ASSY-P210#-A1-20210807  
电子版下载地址: <http://www.piececool.com/cpshuoming/P210.pdf>

拼前需知

● 准备工具:

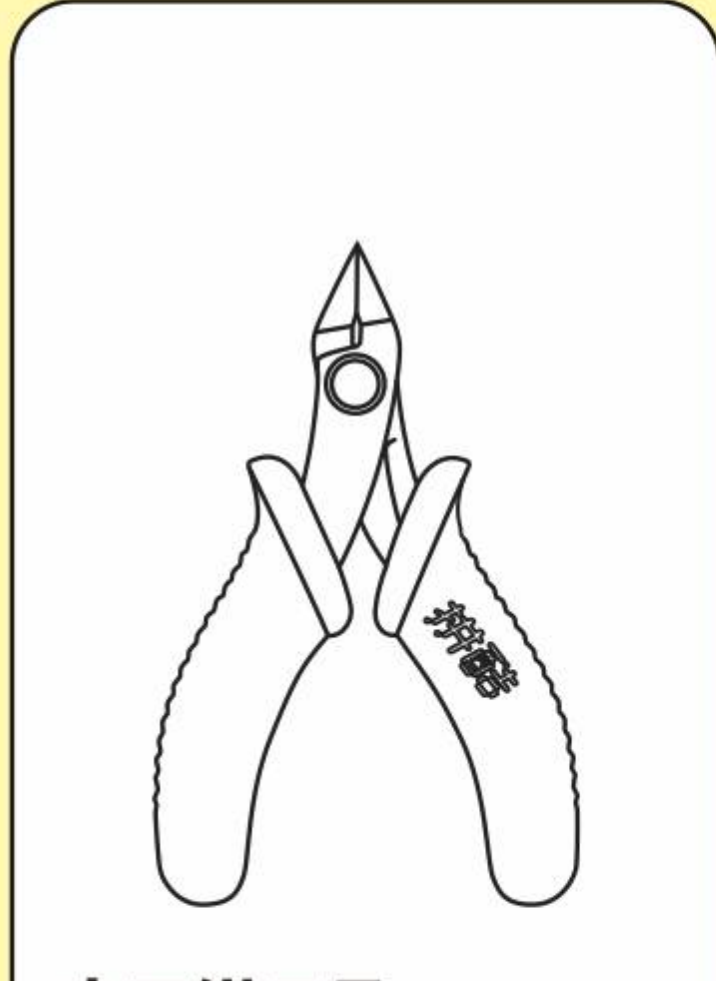

**水口钳工具**  
修剪金属片板件上的零件水口位。

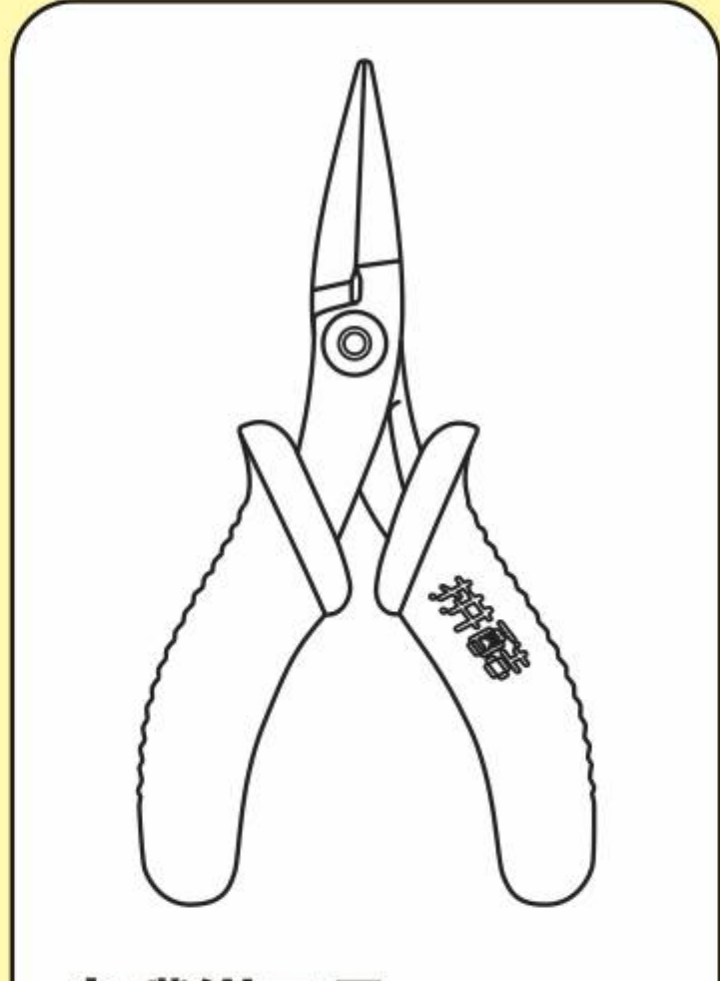

**尖嘴钳工具**  
弯折金属零件上的折叠线和扣点。

建议使用拼酷正品拼装工具(水口钳、尖嘴钳),拼装时更省心、省力,拼装后作品更精细、美观!

⚠️ 组装时请小心处理金属零件,以防划伤

● 拼装方法:

a. 取下零件:



使用水口钳剪断金属零件上的水口,将需要的金属零件从金属片板件取下

b. 识别零件:



识别金属零件上的扣点,折叠线,扣孔的样子

c. 折叠零件:

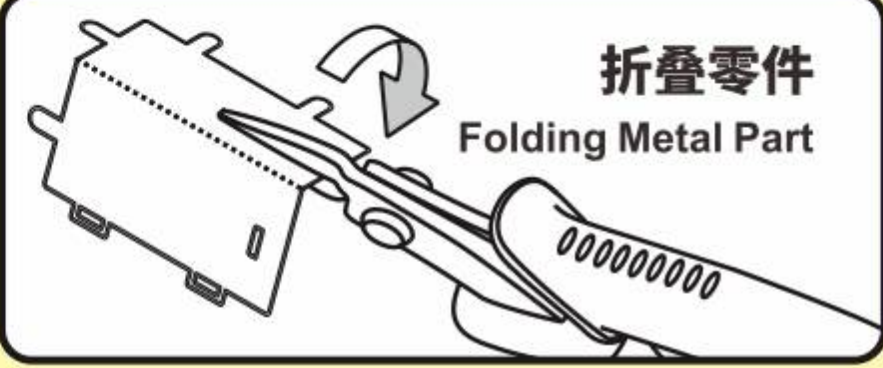

使用尖嘴钳,参照拼装说明书将金属零件折成形状

d. 固定零件:



● 插入扣孔,平折90°



▲ 插入扣孔,旋转90°

● 注意事项:



剪金属零件时请剪零件“水口位”,请勿将“扣点”当成“水口位”剪下,每次剪零件时请仅剪当前步骤的零件,切勿一次性将所有零件全部剪下,避免丢失;  
当遇到折叠线的零件,请注意金属片的正反面及拼折方向,请按照说明书的方向,轻剪慢折,最好一次性折叠完成,请勿反复折叠,避免零件损坏。

© Dongguan Weishi Culture Technology Co.,Ltd. All rights reserved.

拼装步骤

Step01

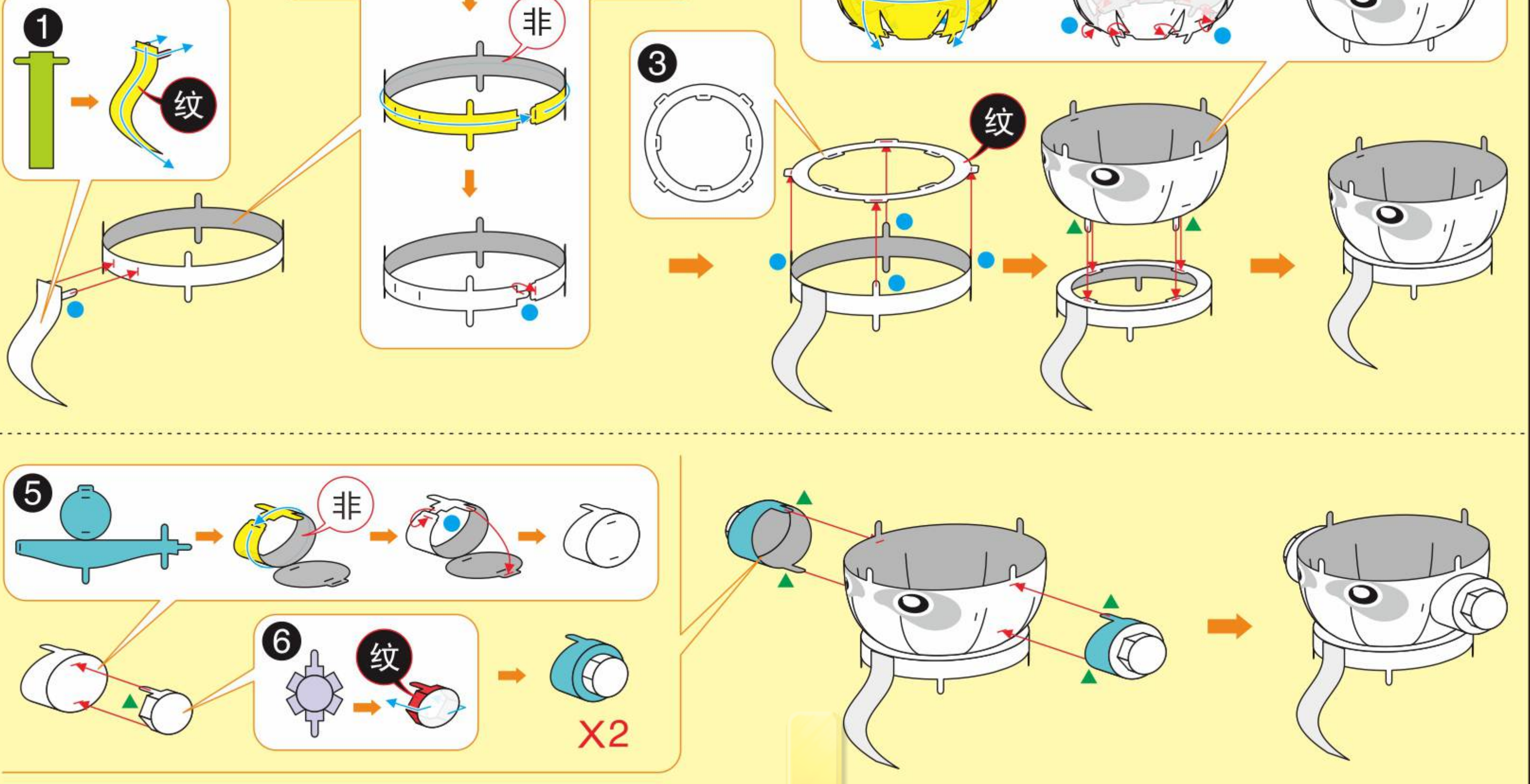

Step02

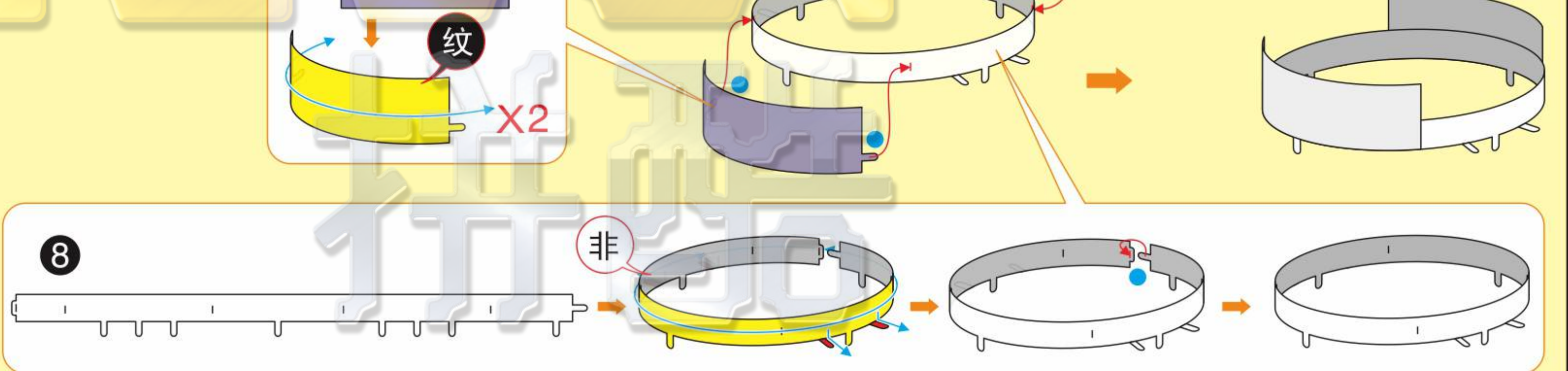

Step03

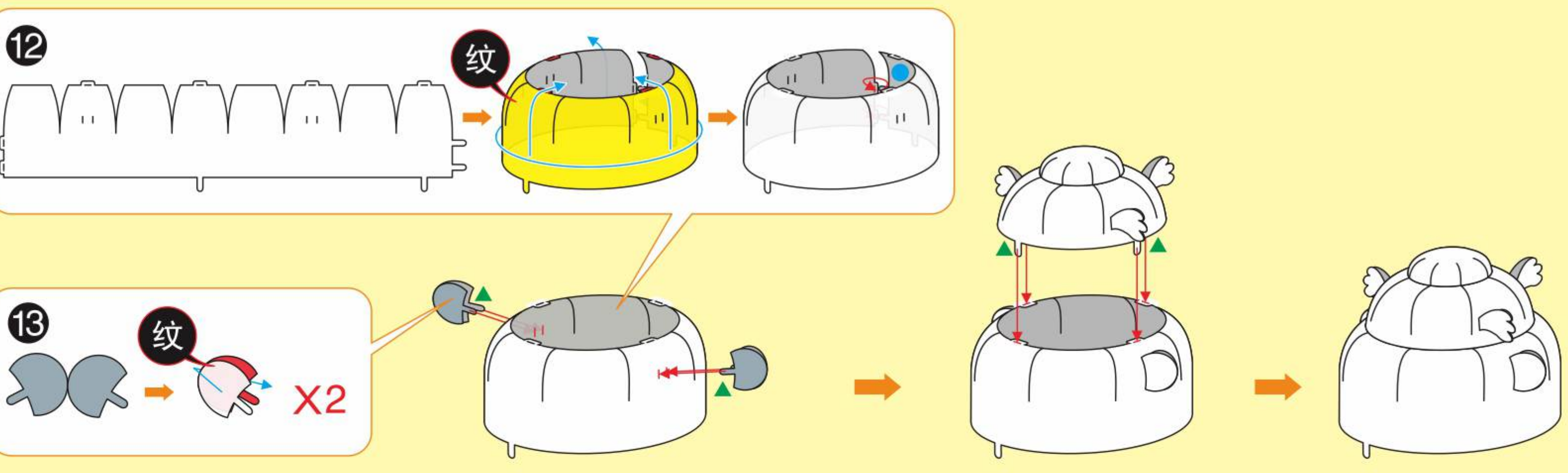
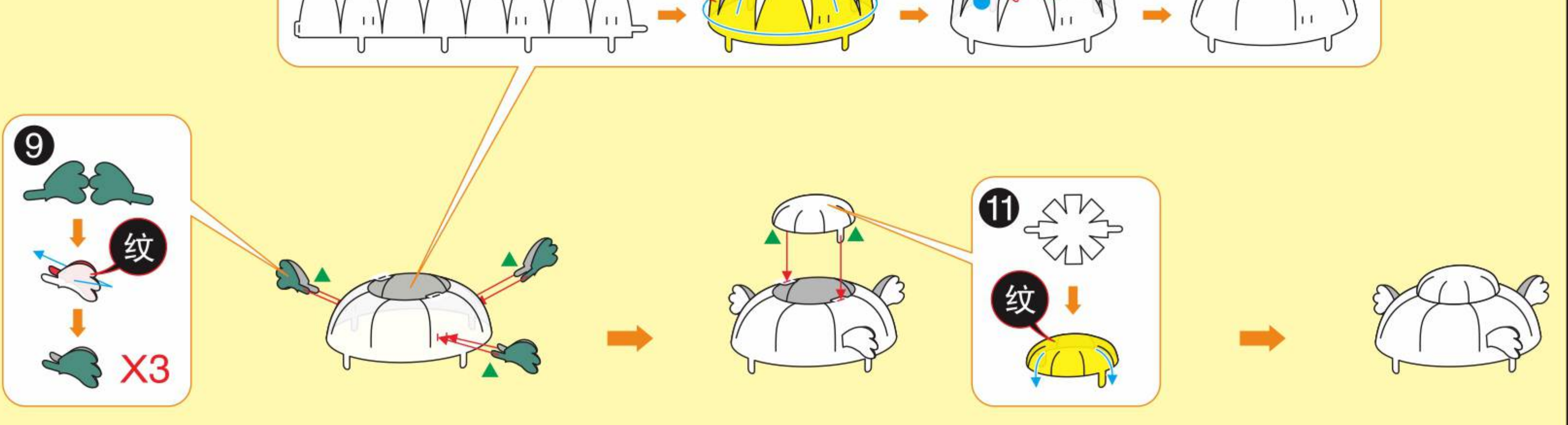

Step04

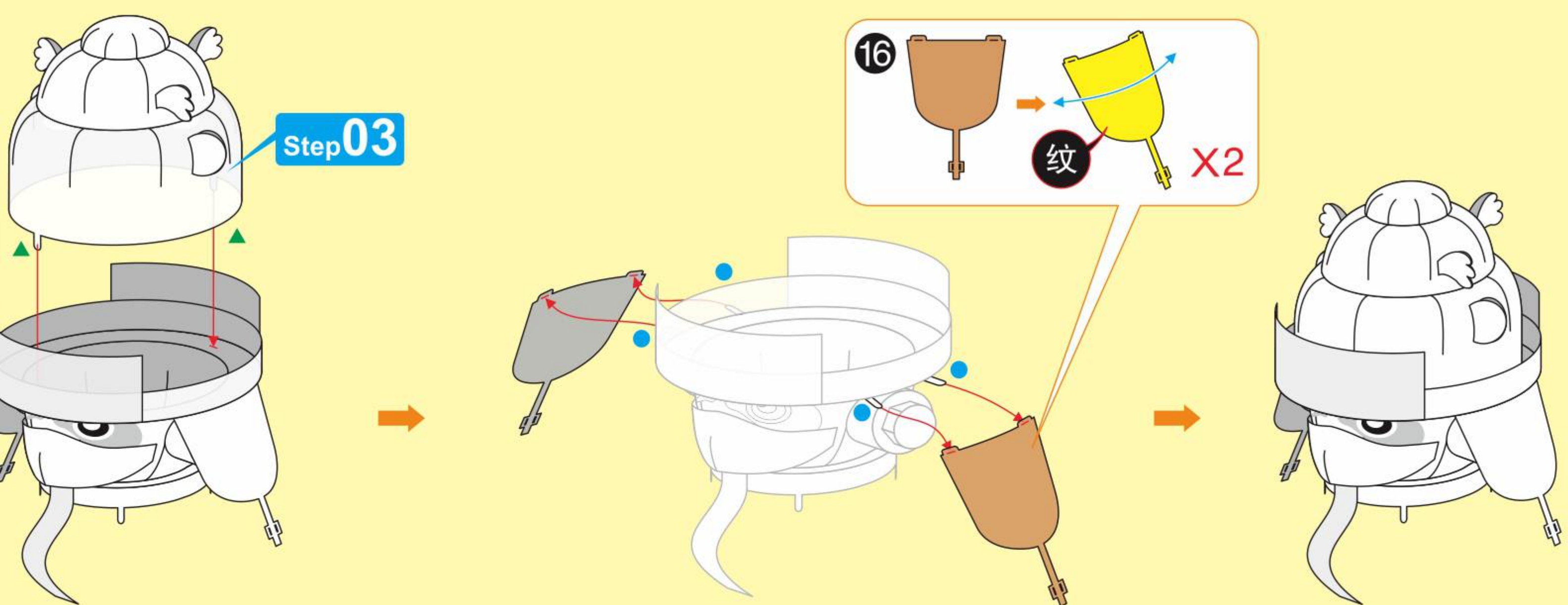
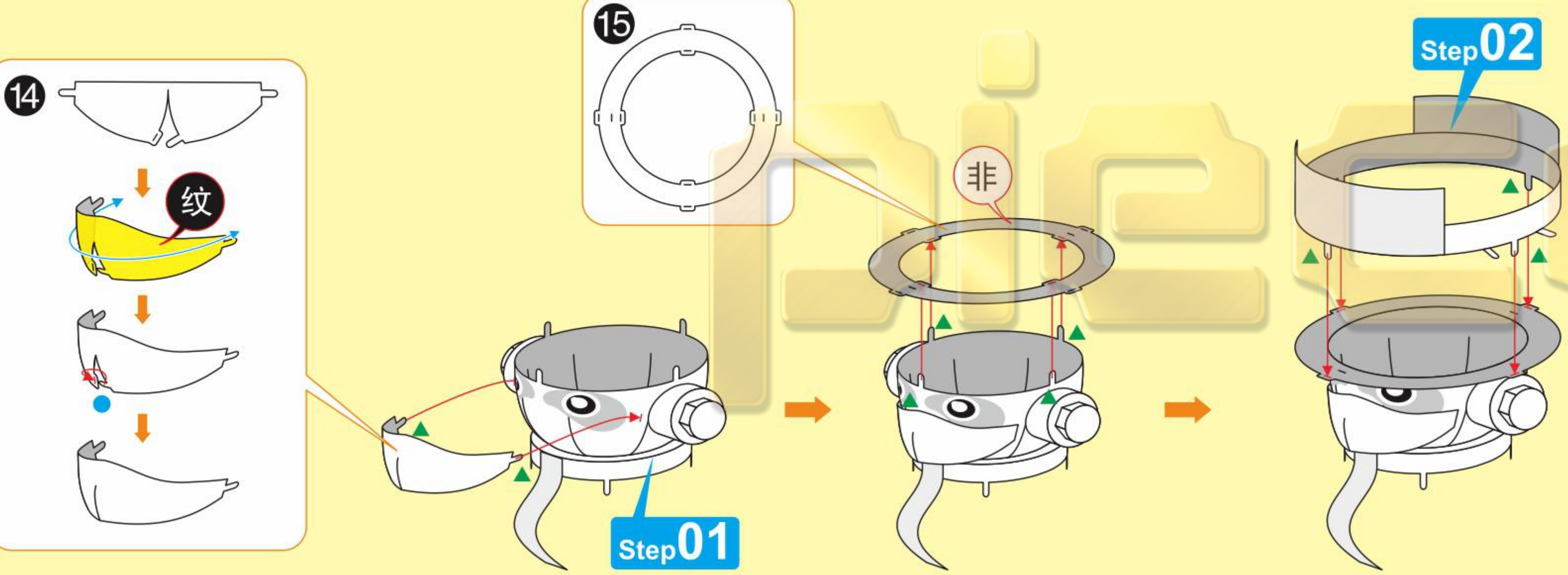

Step05

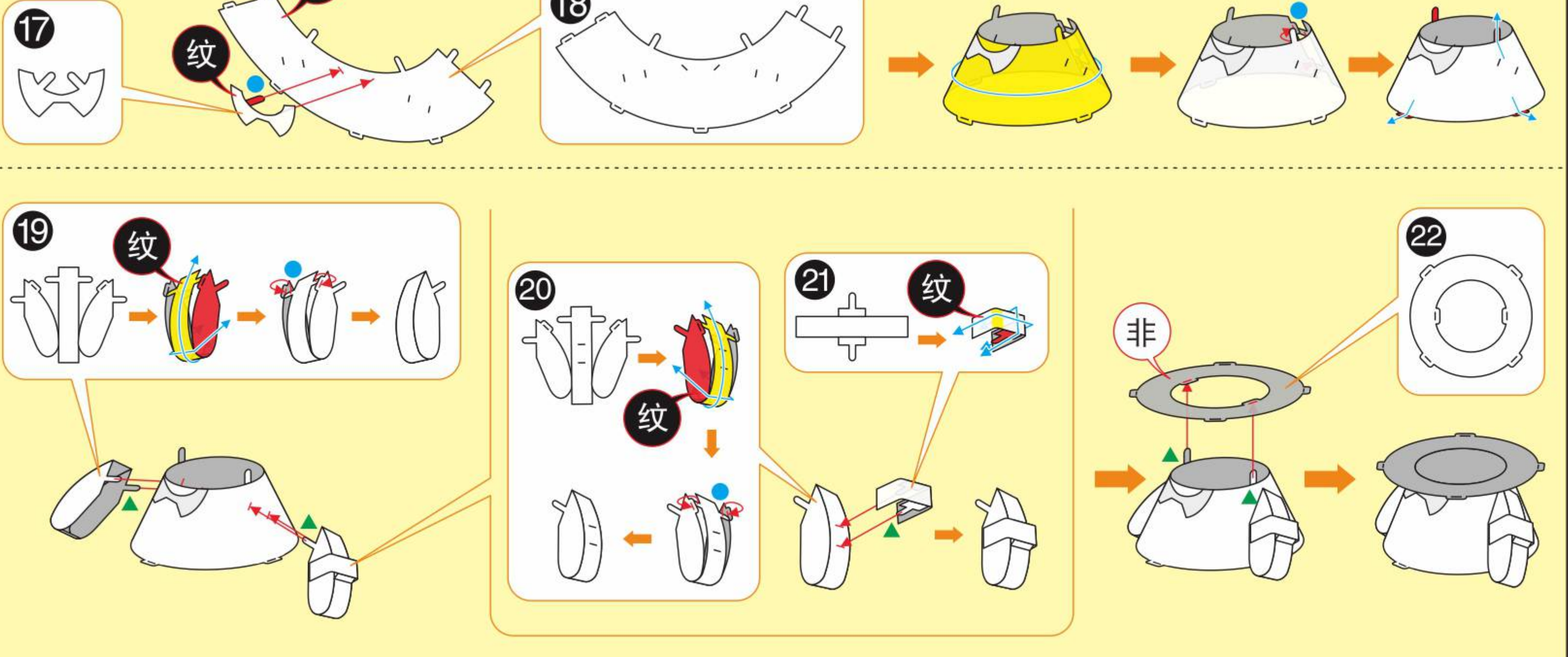

Step06

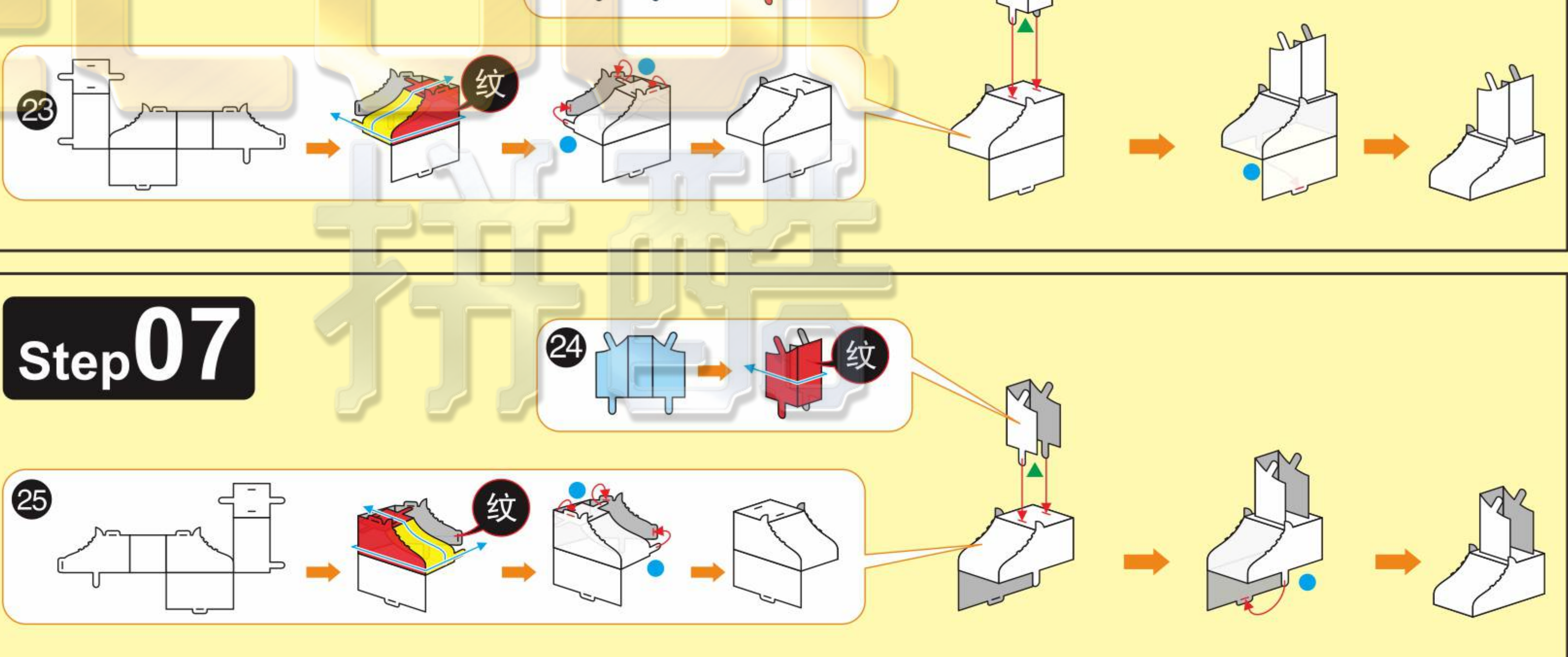

Step07

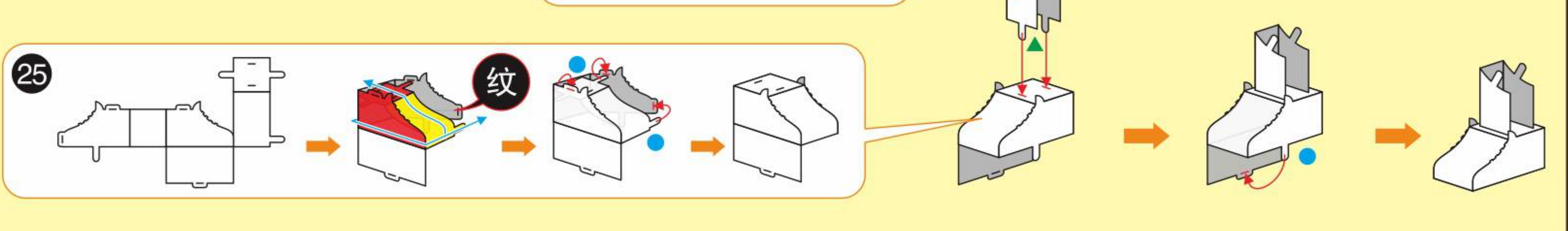

Step08

