



黑暗飞船 MAYRA'S WARSHIP P074-GS

拼装说明书

拼装提示 TIPS:

本产品采用扣点与扣位卡扣拼折的拼装方式，未发生拼装损坏，无需使用胶水 

建议购买并使用拼酷正品拼装工具， T-SKQ05 水口钳  ， T-JZQ05 尖嘴钳  ， 拼装更省时省力，作品更精细美观！

请参照包装内说明书进行拼装，请勿反复拼折金属零件，以免损坏。

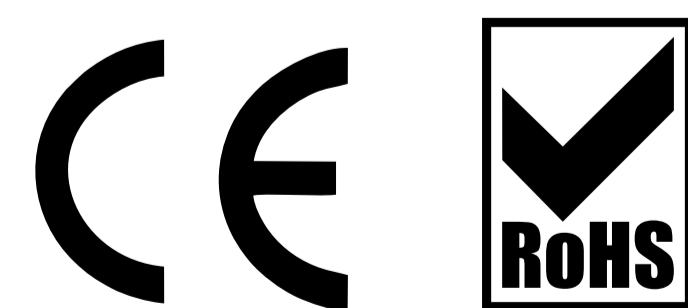

AGES 14+

本产品为金属制品，14岁以下需由成人陪同完成！

74

Piececool 拼酷

创意金属，拼酷模玩！

黑暗飞船

MAYRA'S WARSHIP

挑战星级 Difficulty Level



P074-GS

拼酷

MAYRA'S WARSHIP

Piececool
拼酷



精灵王座

THRONE OF ELVES

AGES 14+

本产品为金属制品，14岁以下需由成人陪同完成！

正版
授权

品类多样，寓意丰富，收藏，送礼两相宜！
DIY拼装，动手动脑，乐趣多多！

P074

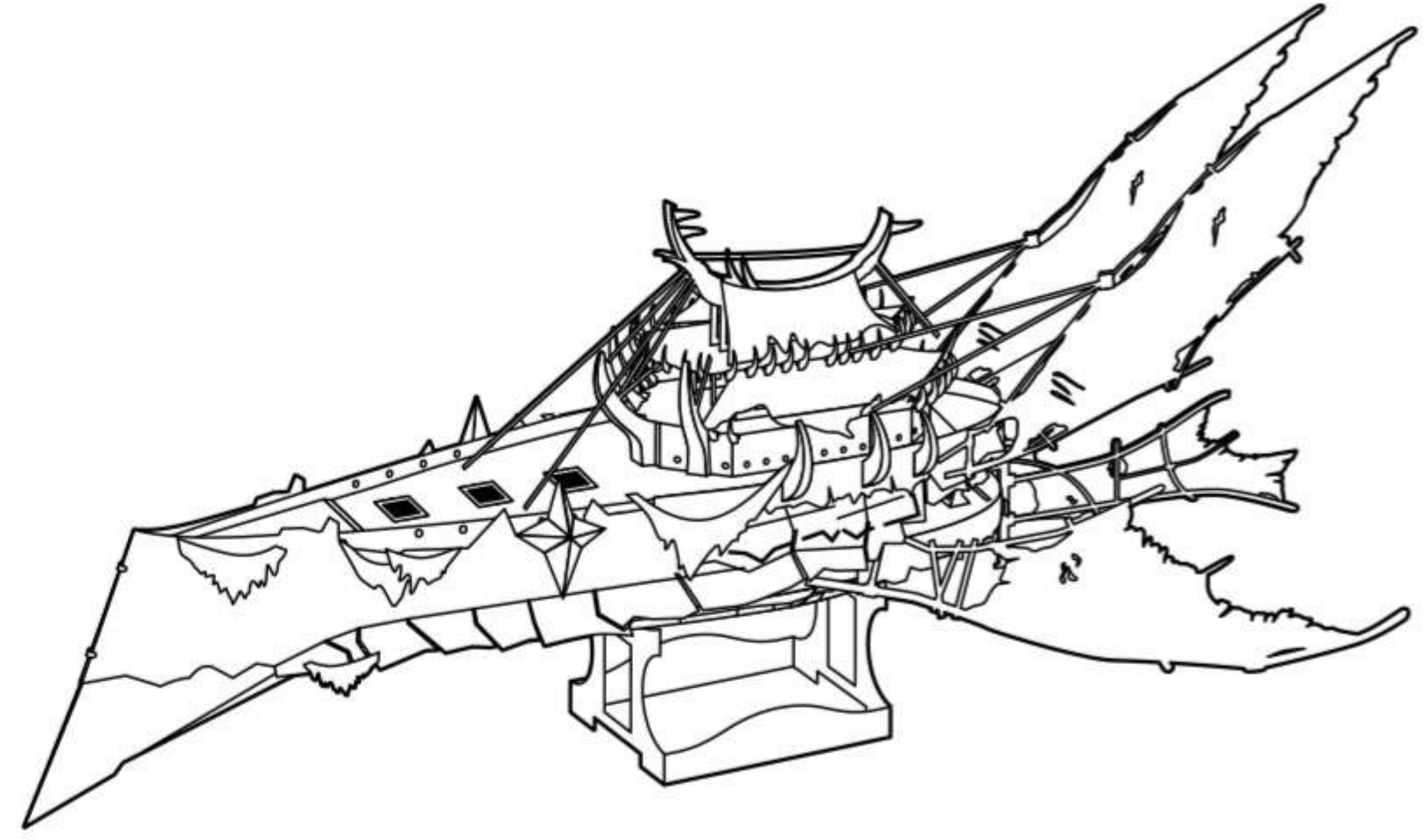

组装基本步骤示意图

● 插入扣孔, 平折 90°

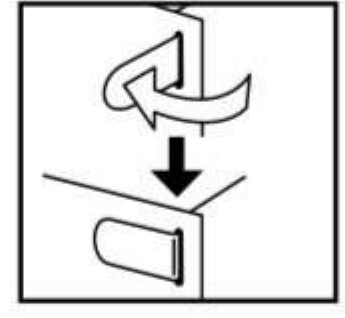

▲ 插入扣孔, 旋转 90°

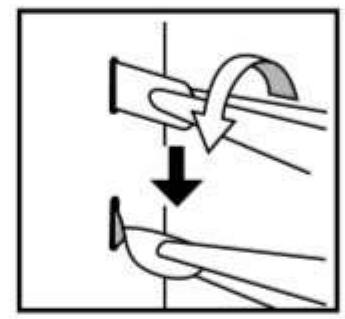

金属部件

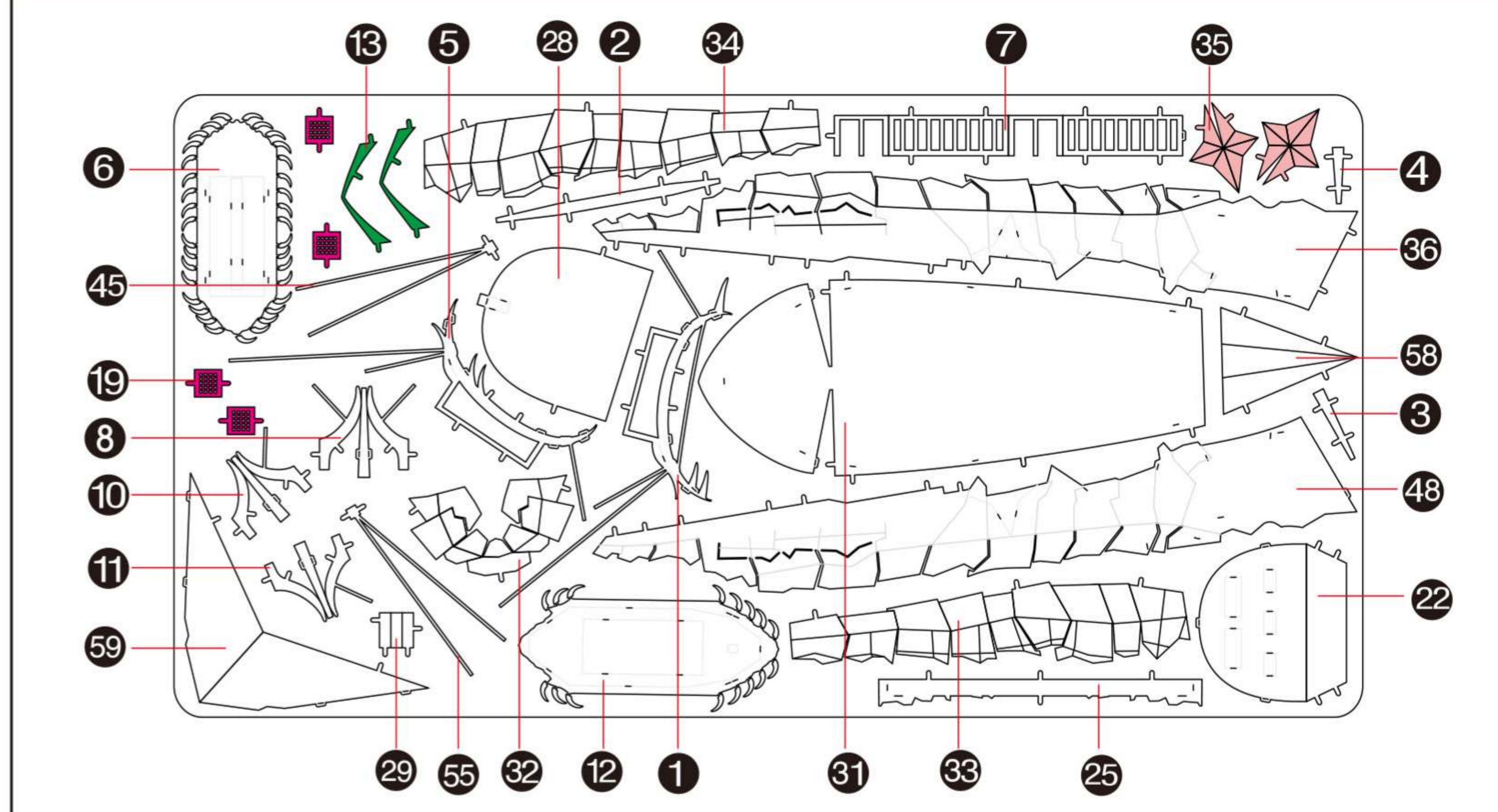
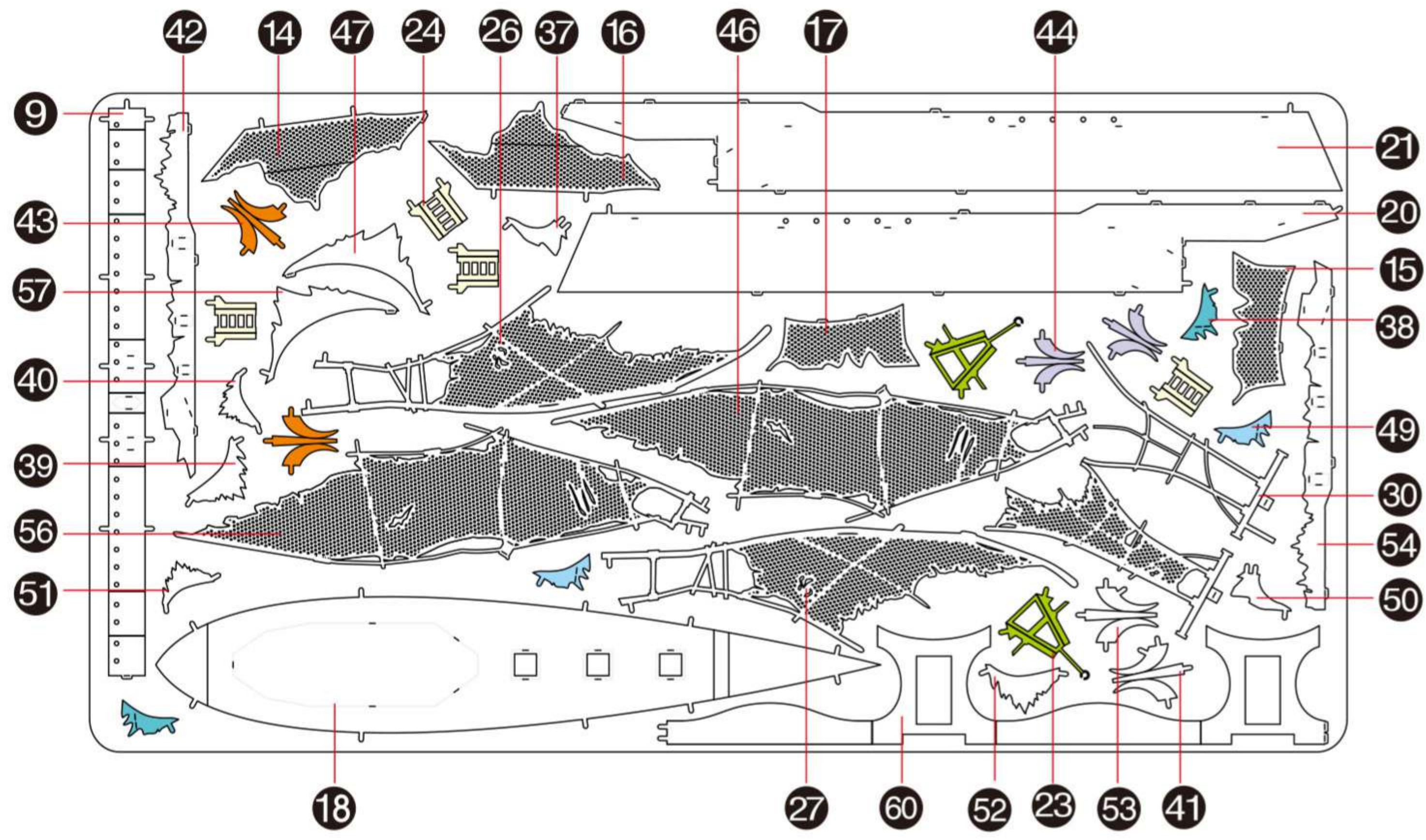

拼装步骤

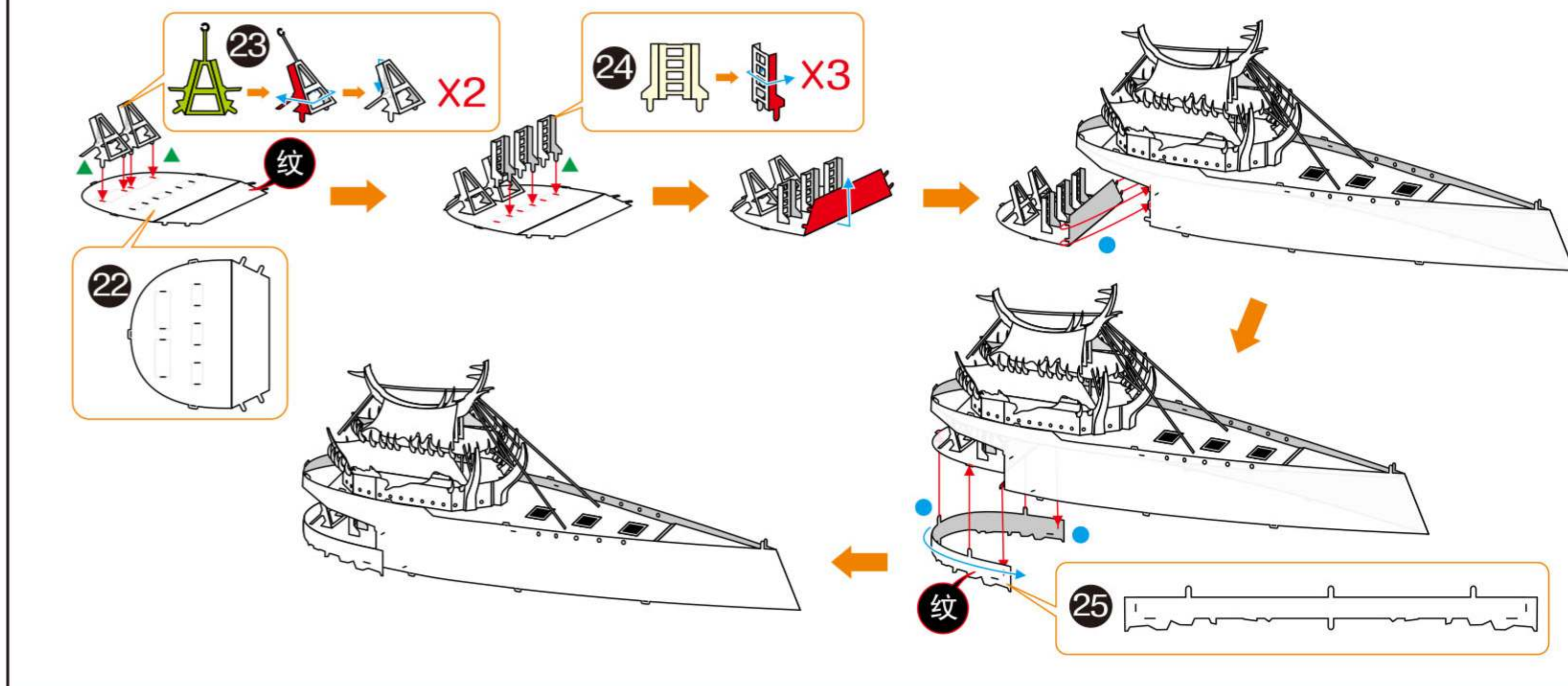
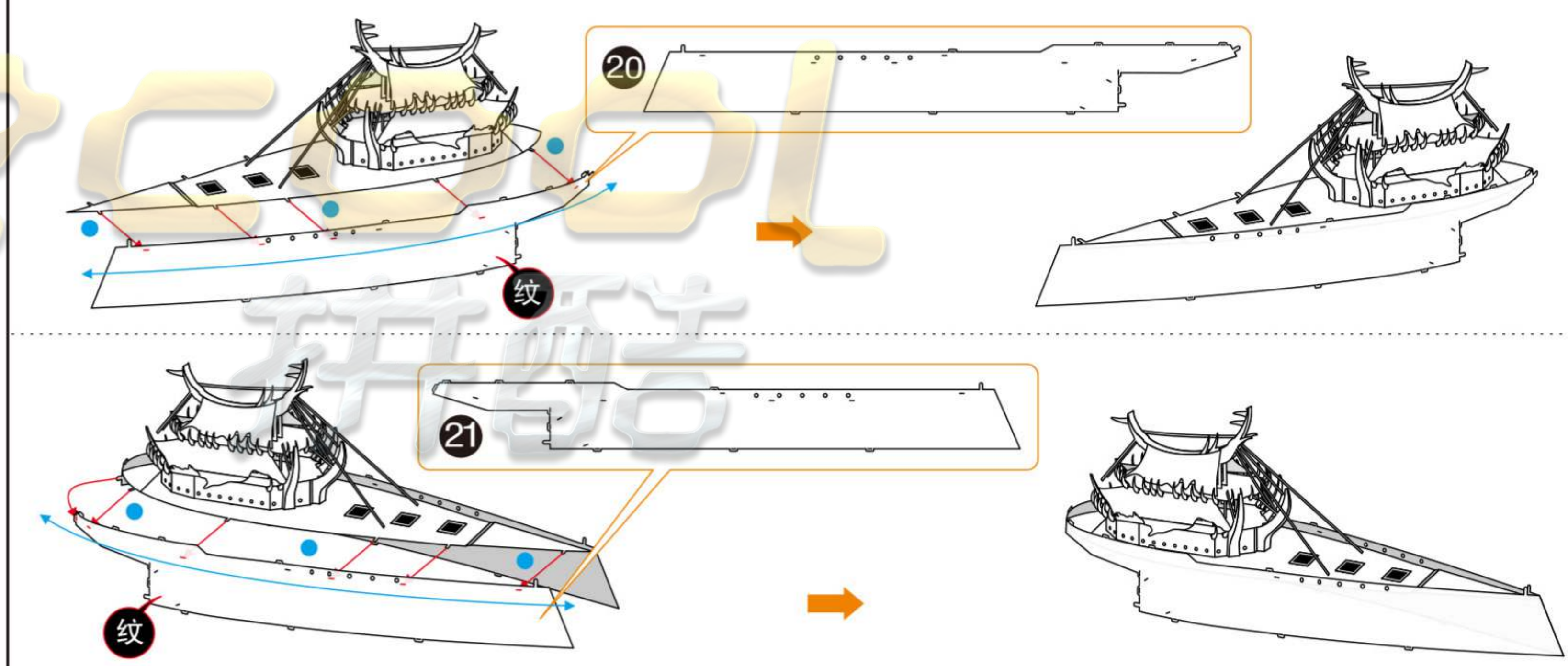
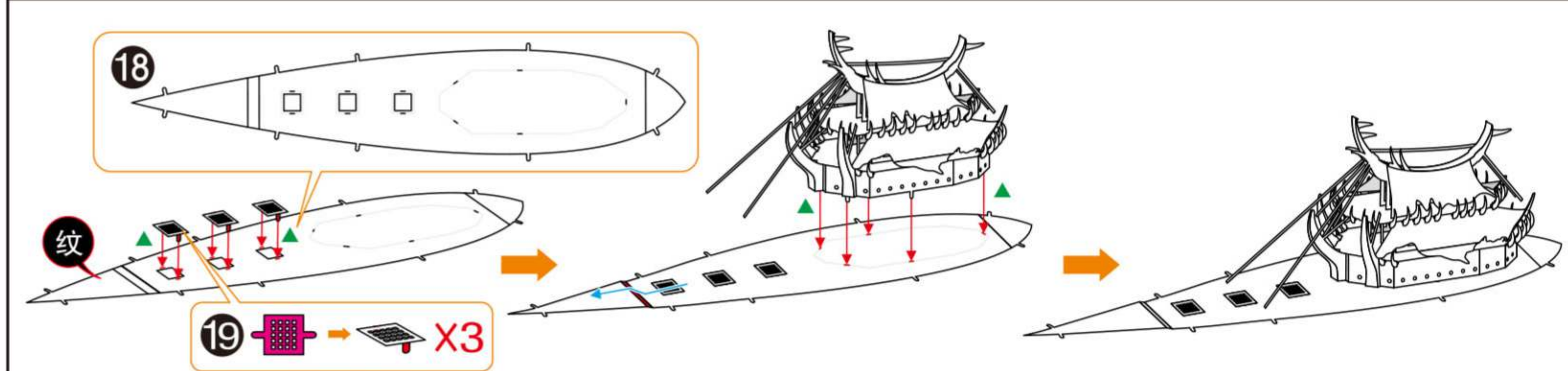
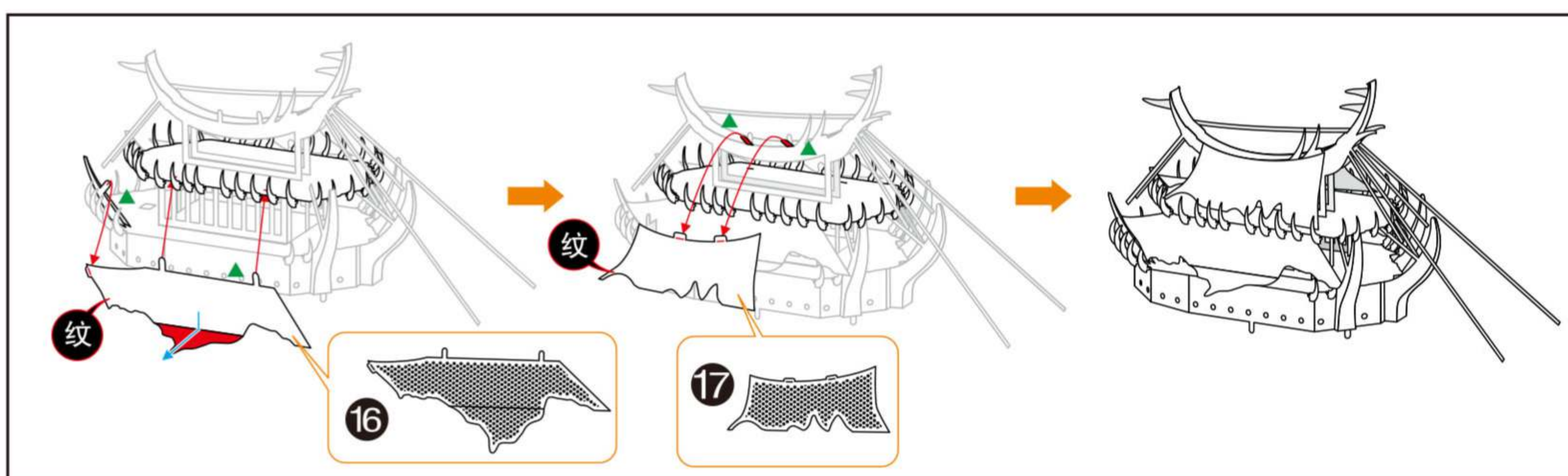
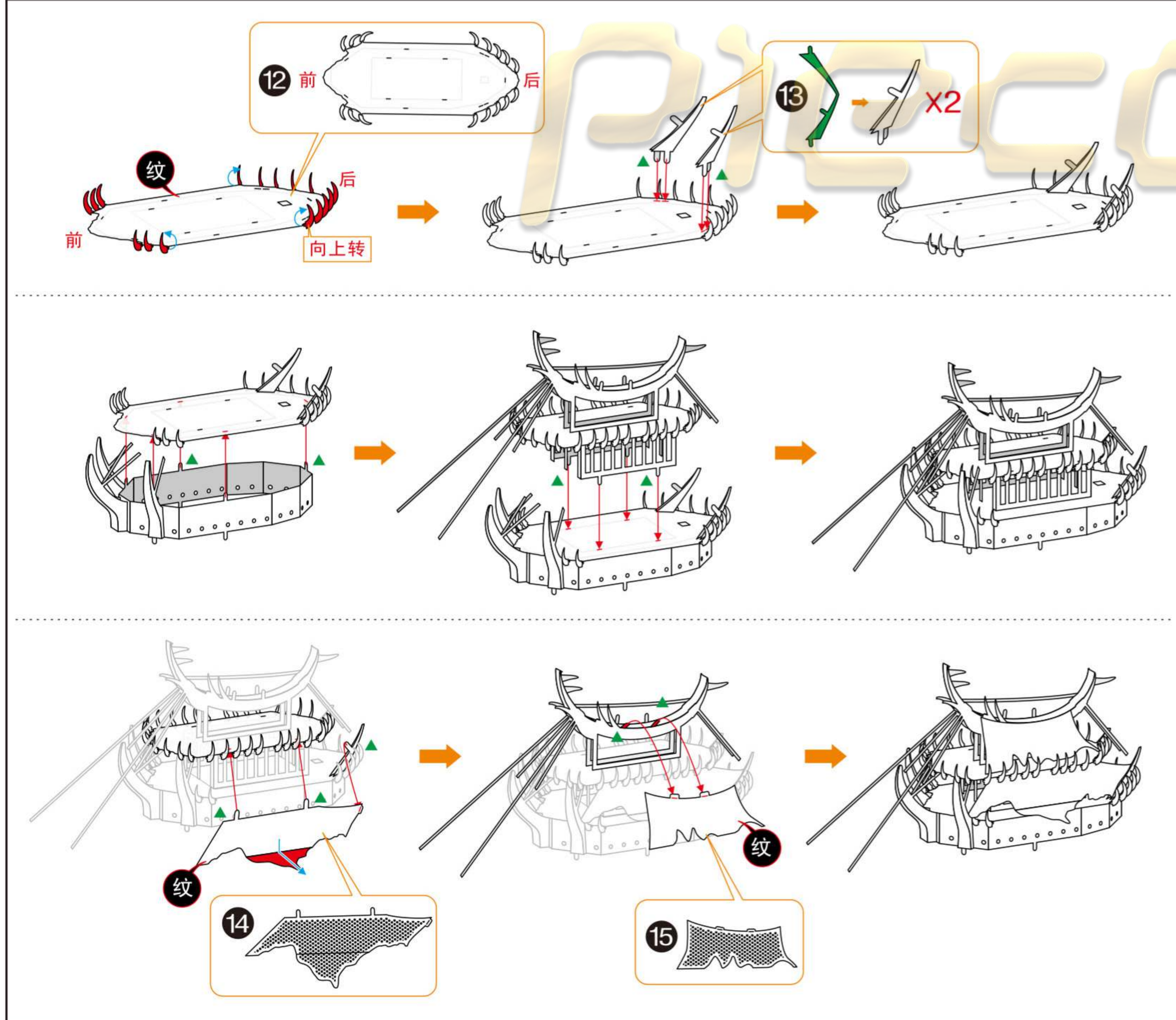
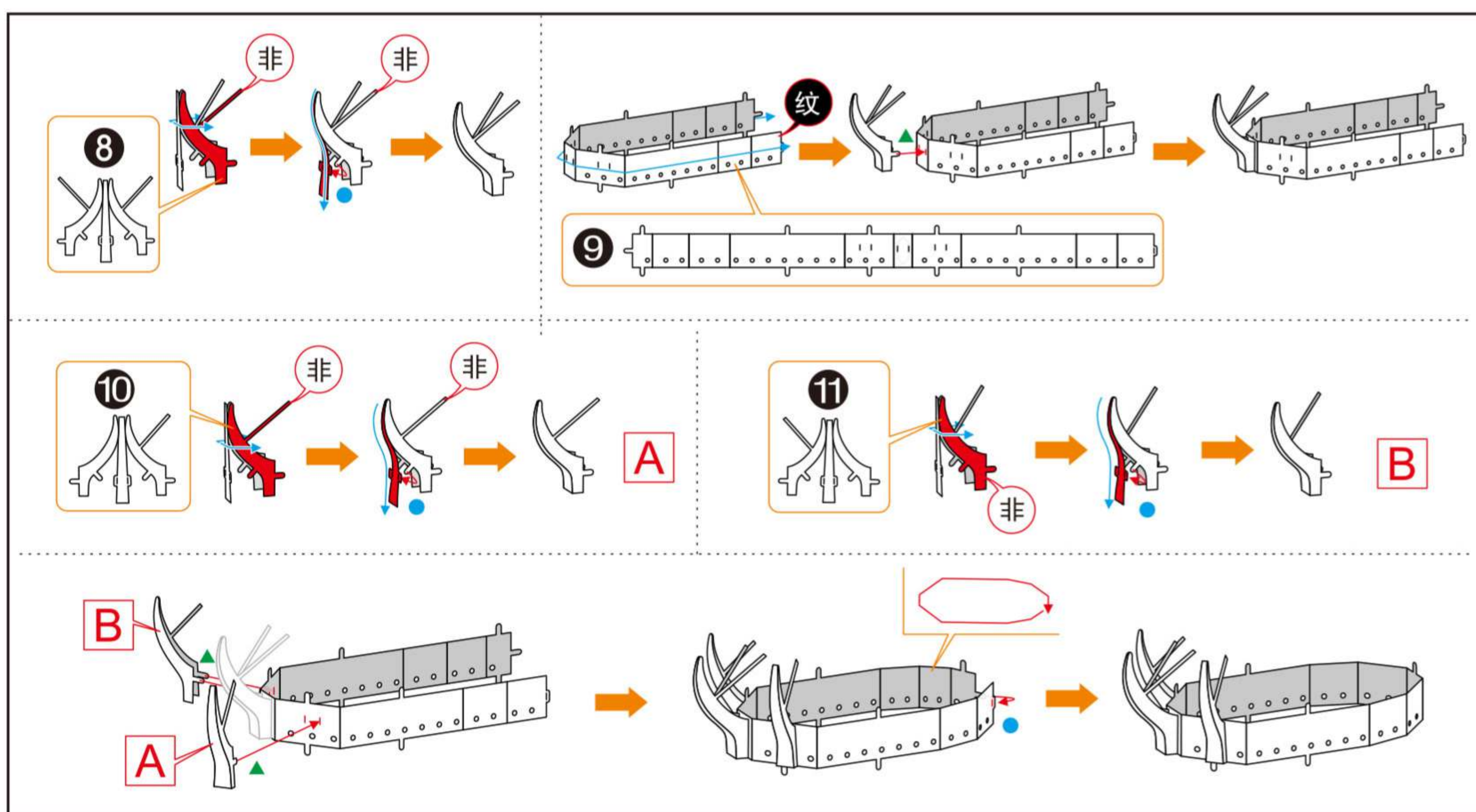
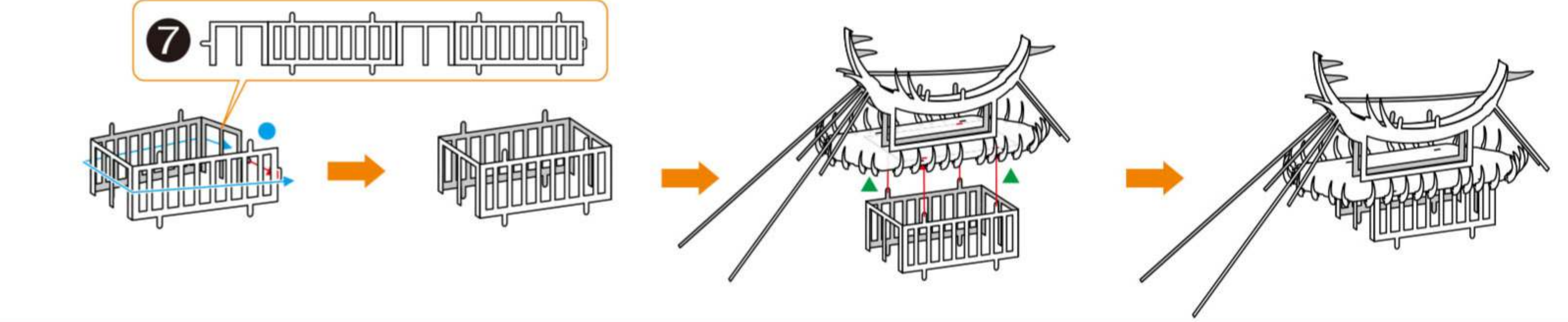
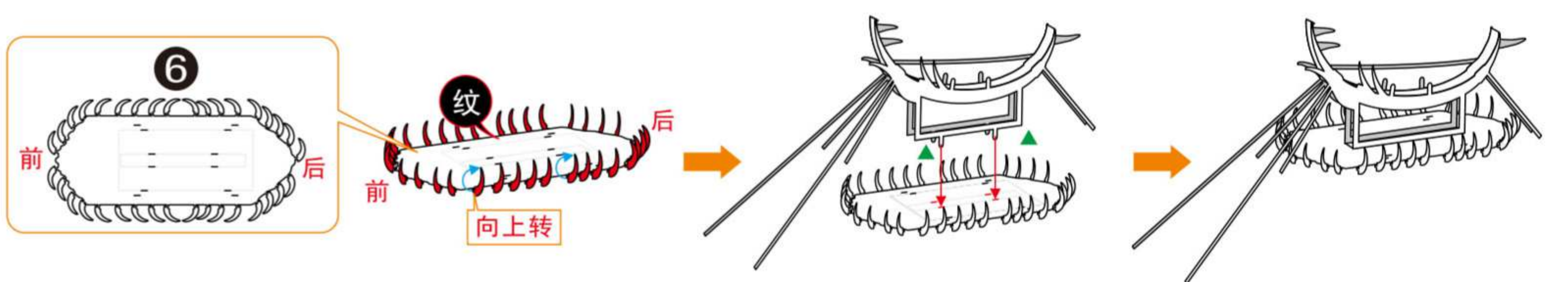
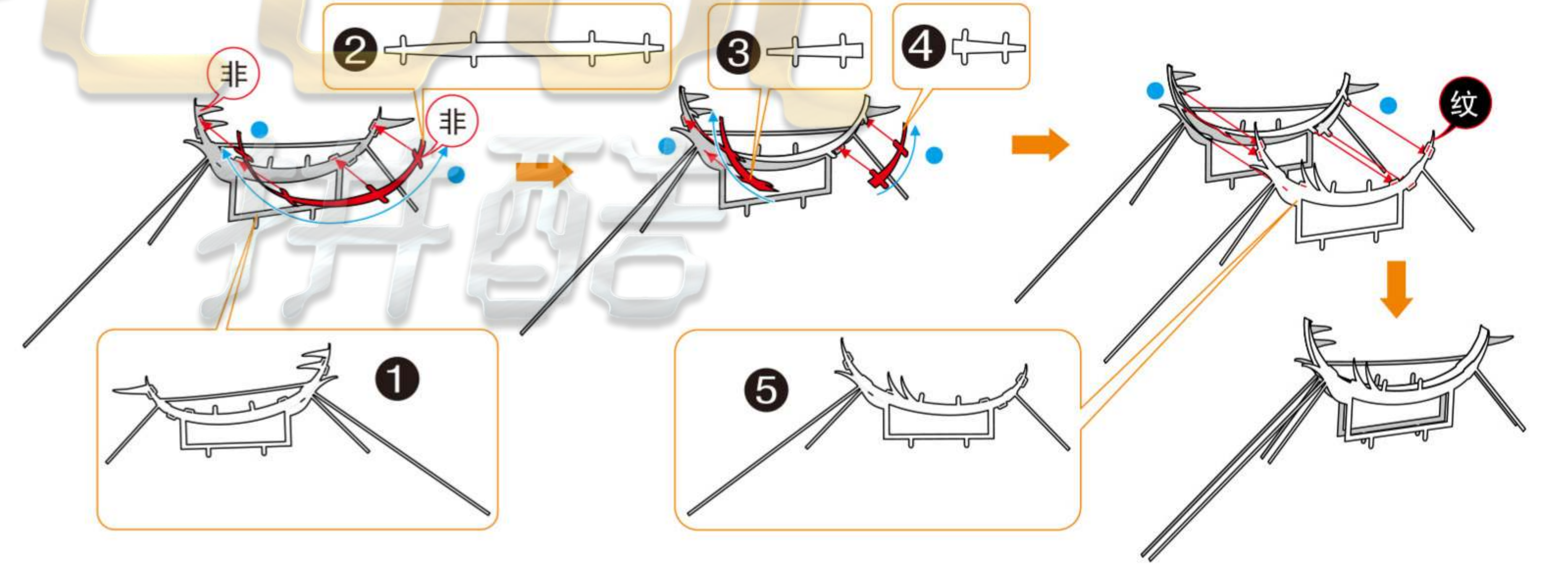

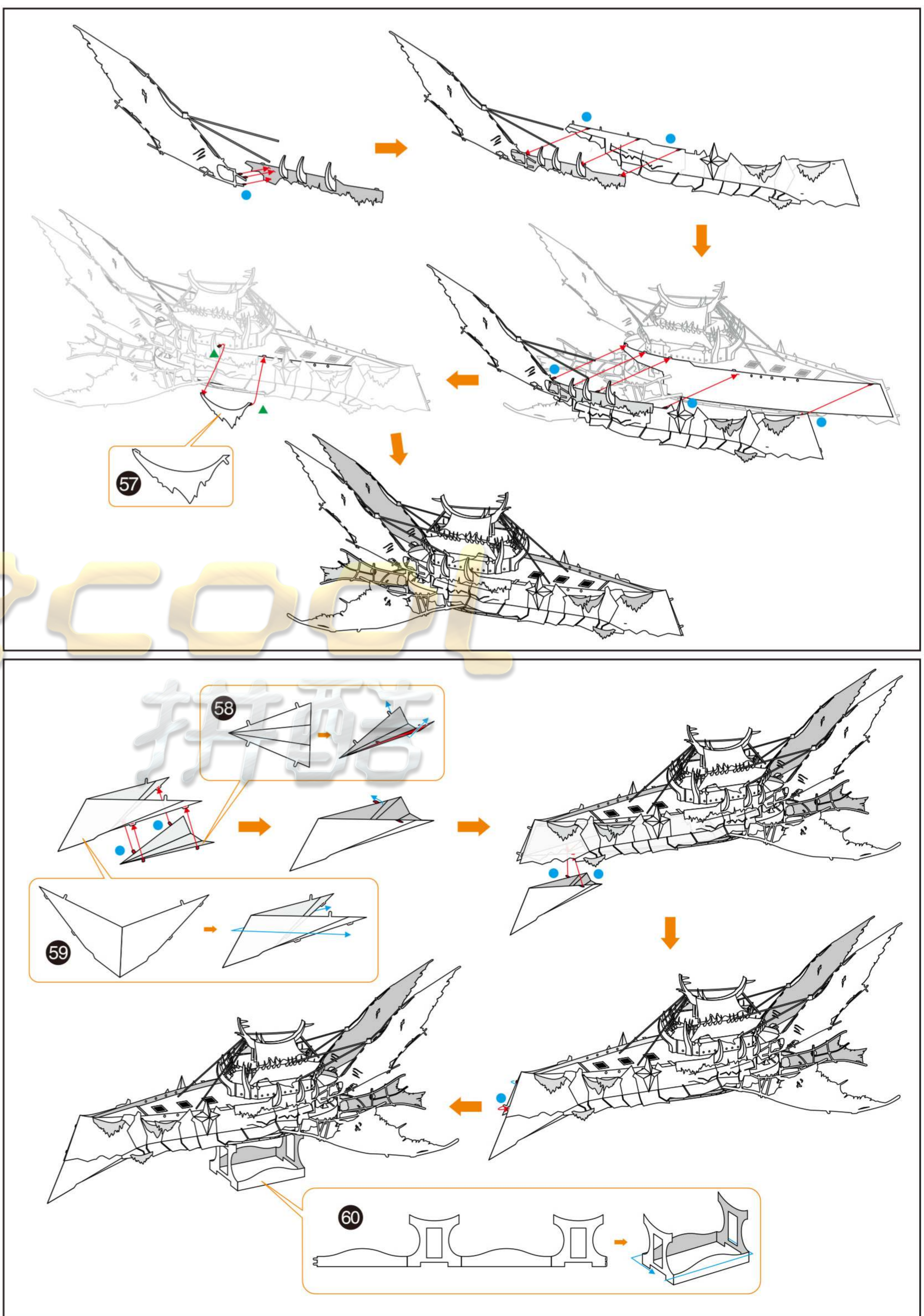
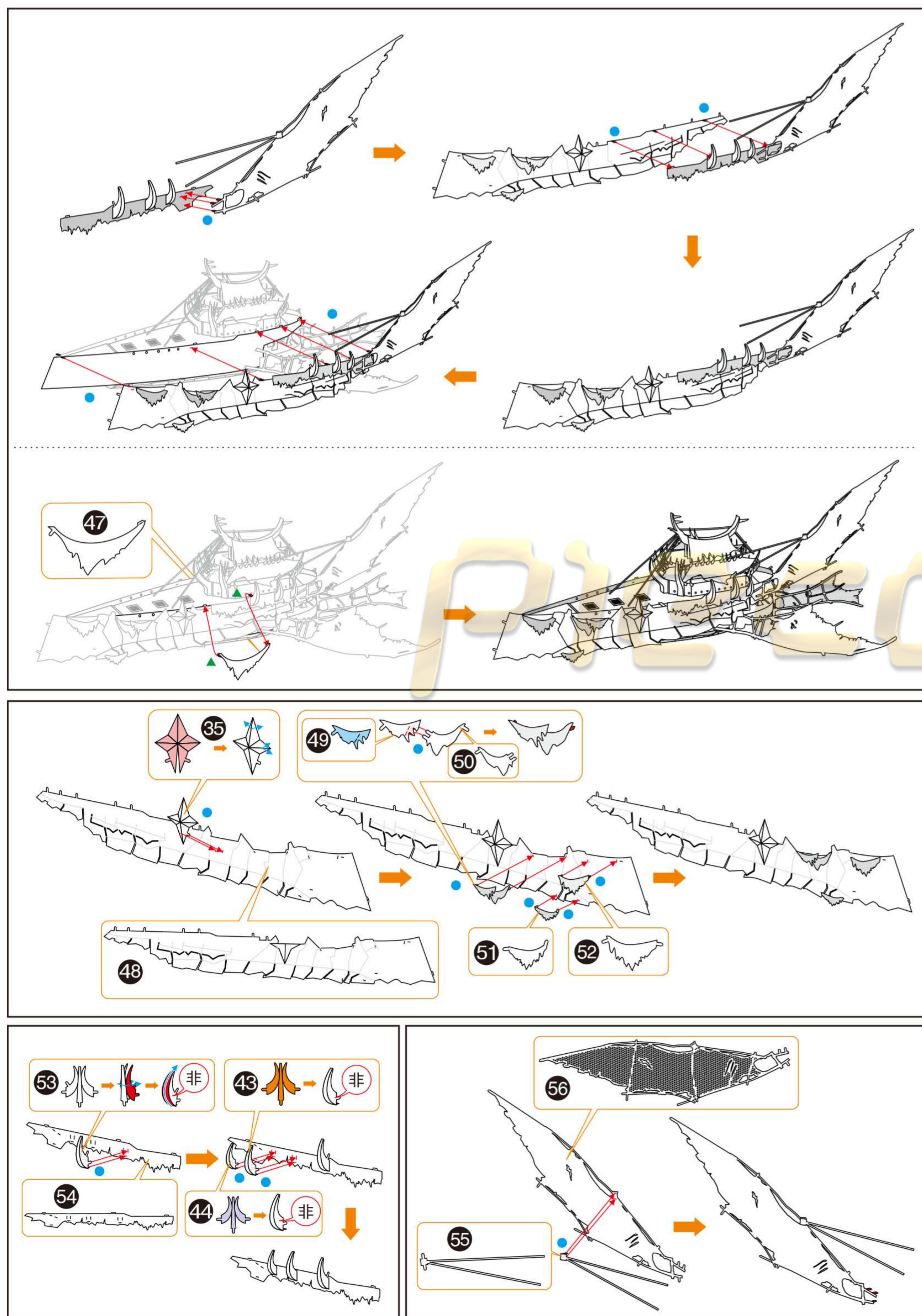
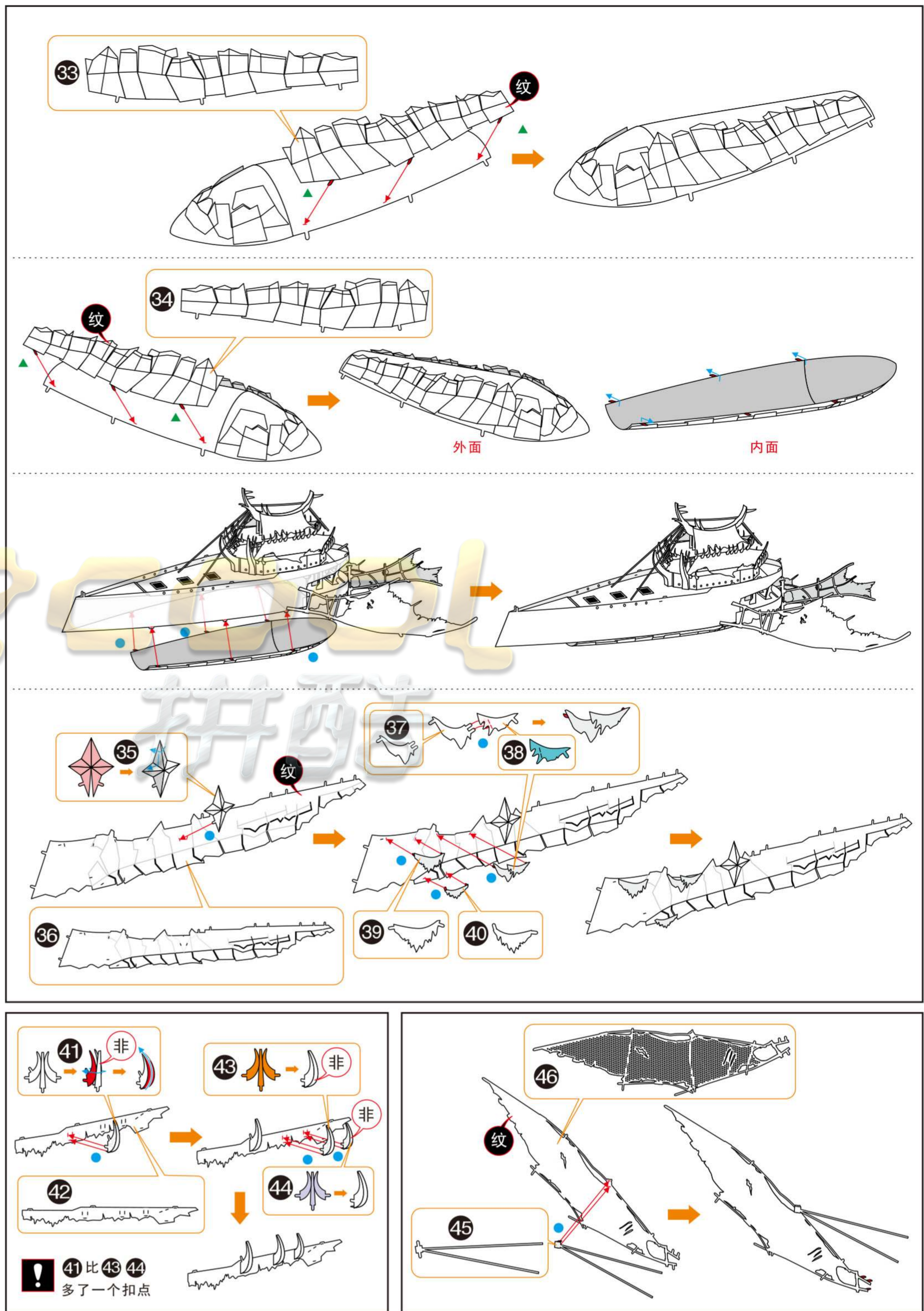
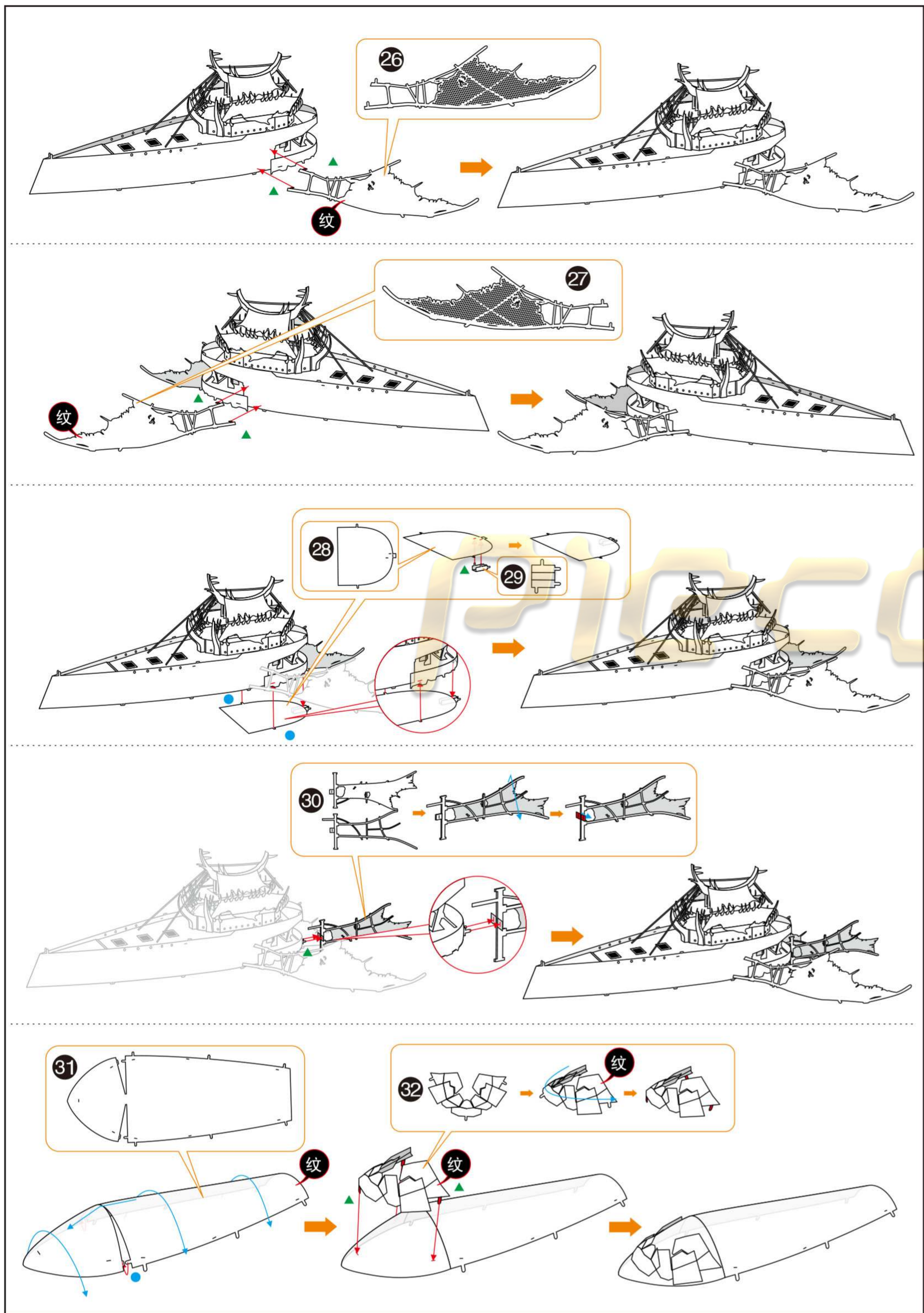

Piececool
拼酷

www.Piececool.com

© WIST PLASTIC & METAL TECHNOLOGY LIMITED. ALL RIGHTS RESERVED.