



玫拉
MAYRA
P073-G

拼装说明书

拼装提示 TIPS:

本产品采用扣点与扣位卡扣拼折的拼装方式，未发生拼装损坏，无需使用胶水 

建议购买并使用拼酷正品拼装工具， T-SKQ05 水口钳  ， T-JZQ05 尖嘴钳  ， 拼装更省时省力，作品更精细美观！

请参照包装内说明书进行拼装，请勿反复拼折金属零件，以免损坏。

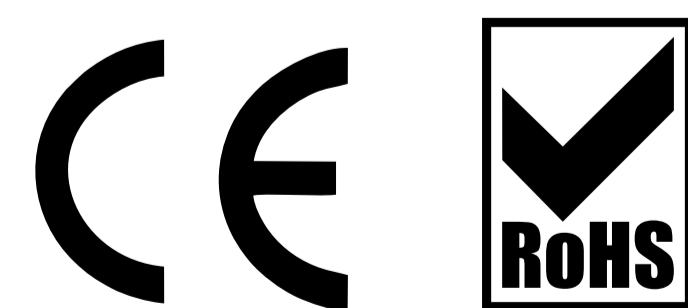

AGES 14+

本产品为金属制品，14岁以下需由成人陪同完成！

73

piececool 拼酷

玫拉 MAYRA

P073-G

挑战星级 Difficulty Level



玫拉 MAYRA

piececool 拼酷

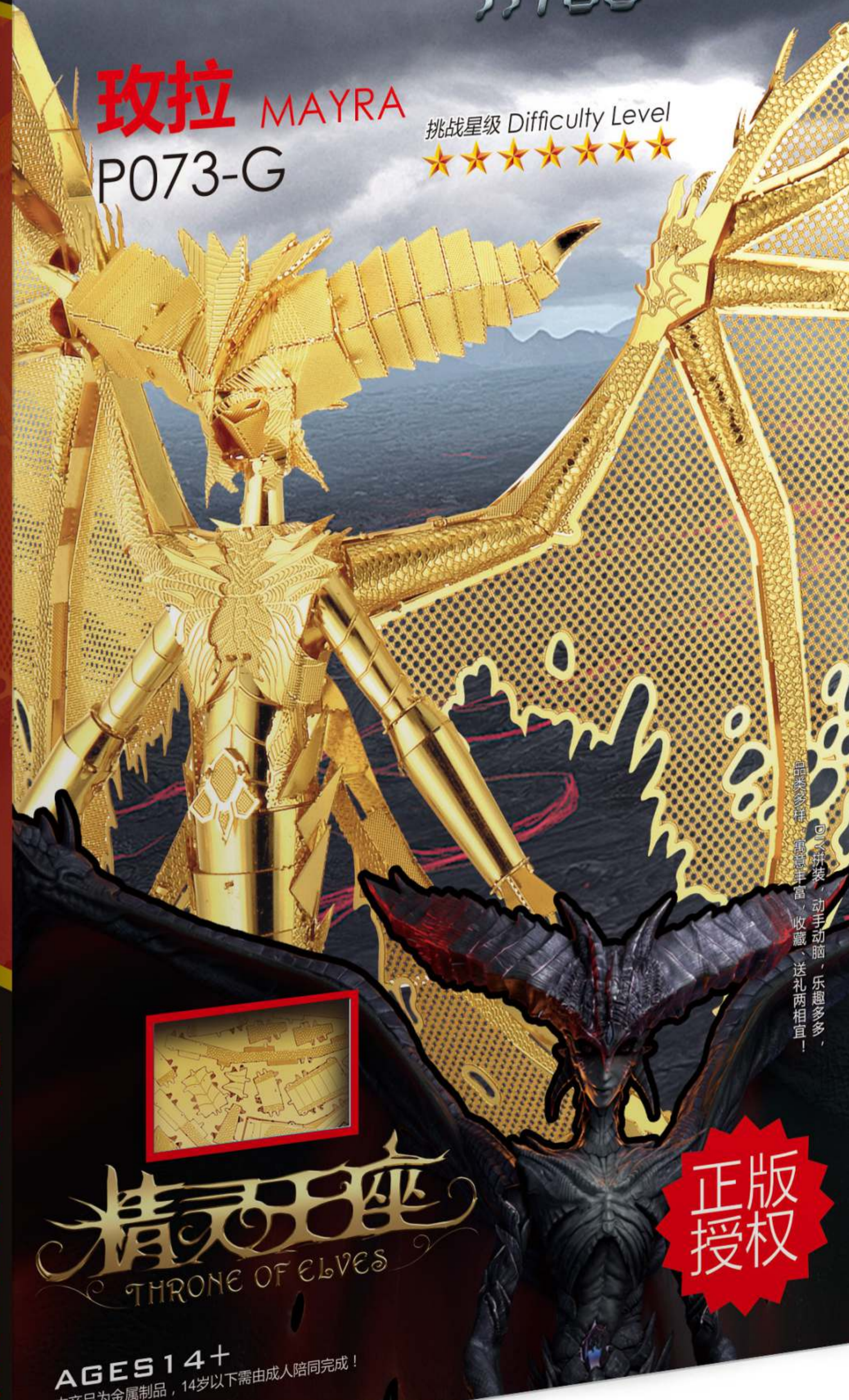

精灵王座 THRONE OF ELVES

正版
授权

AGES 14+

本产品为金属制品，14岁以下需由成人陪同完成！

动手动脑，乐趣多多，
收藏、送礼两相宜！

组装基本步骤示意图

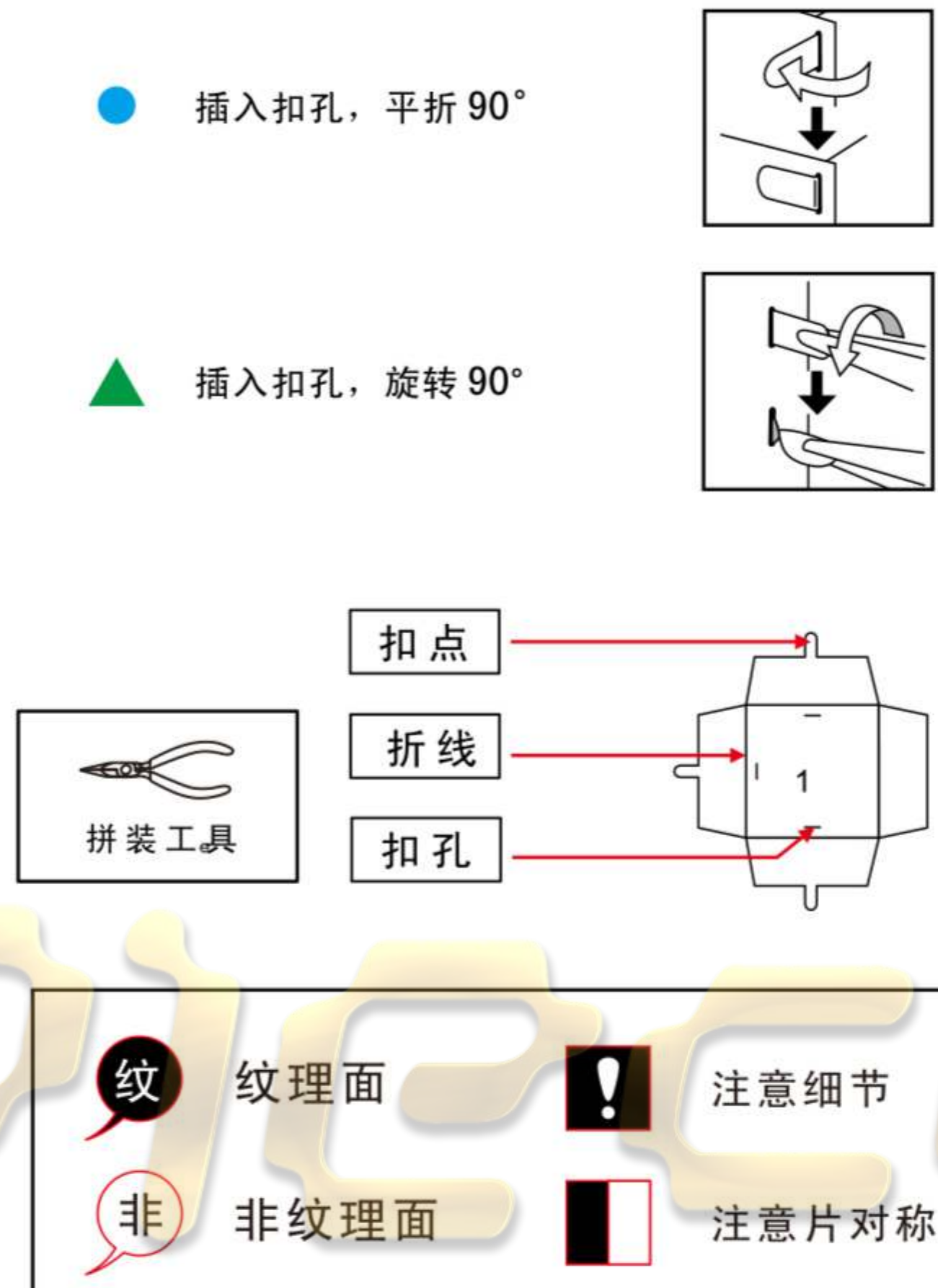
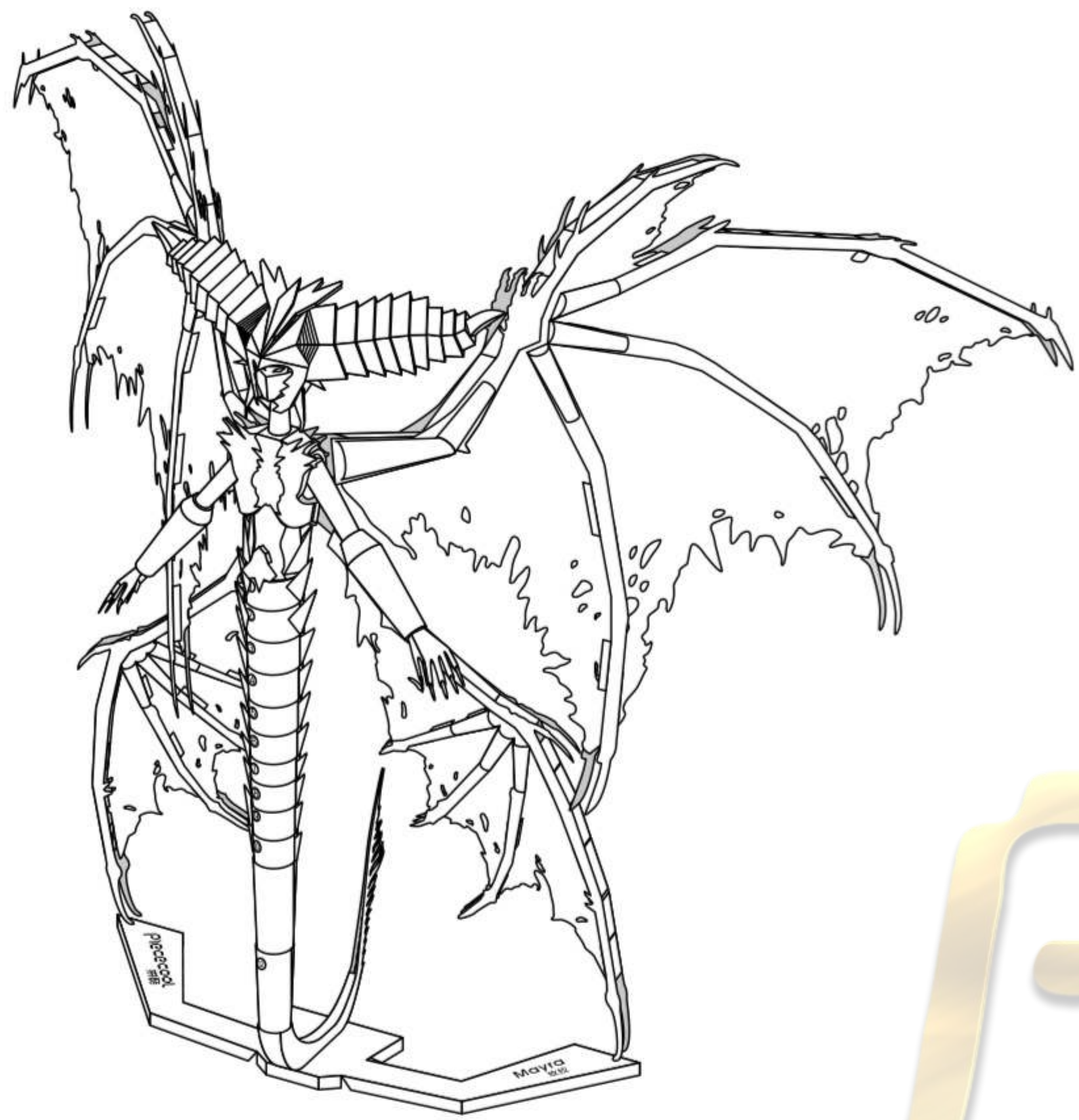

金属部件

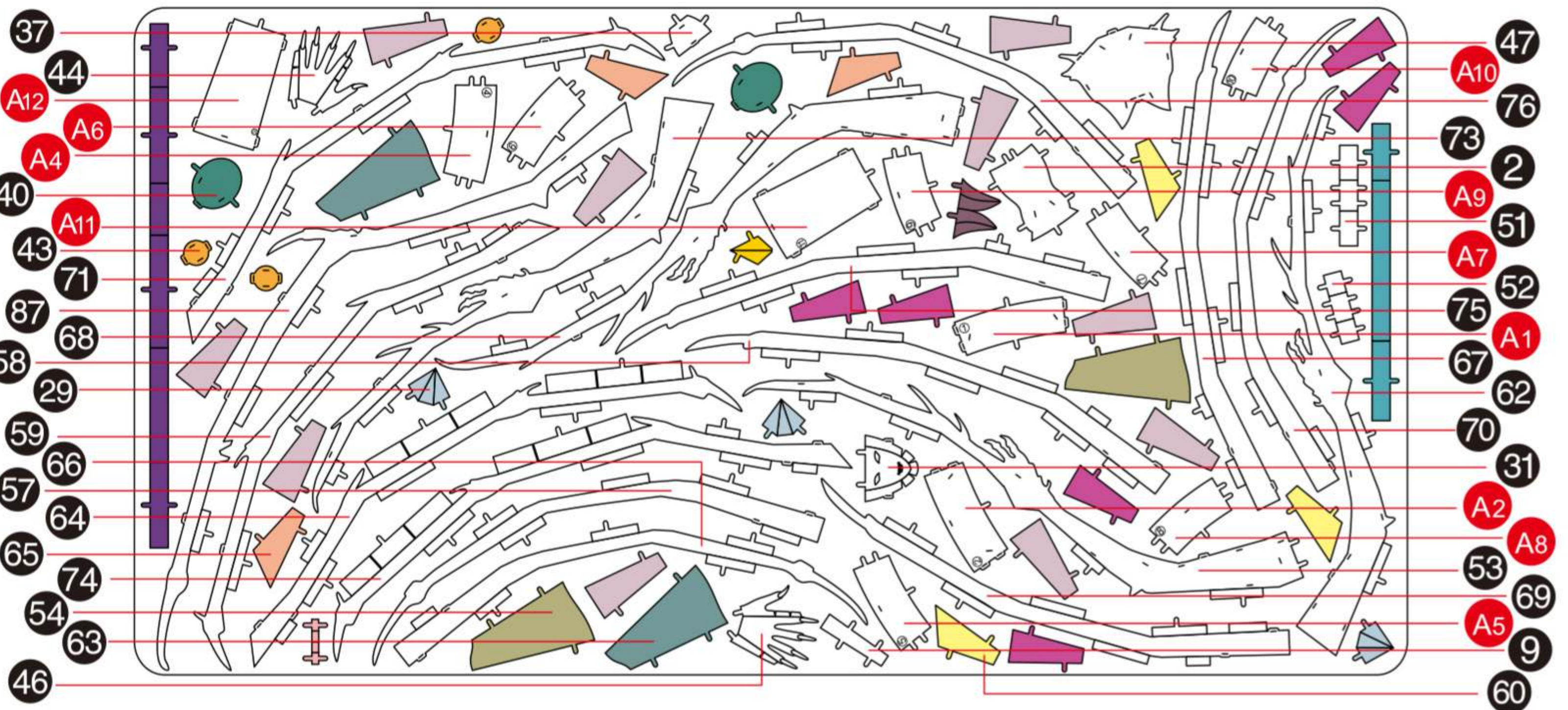

⚠ 请小心处理金属边料, 以防划伤

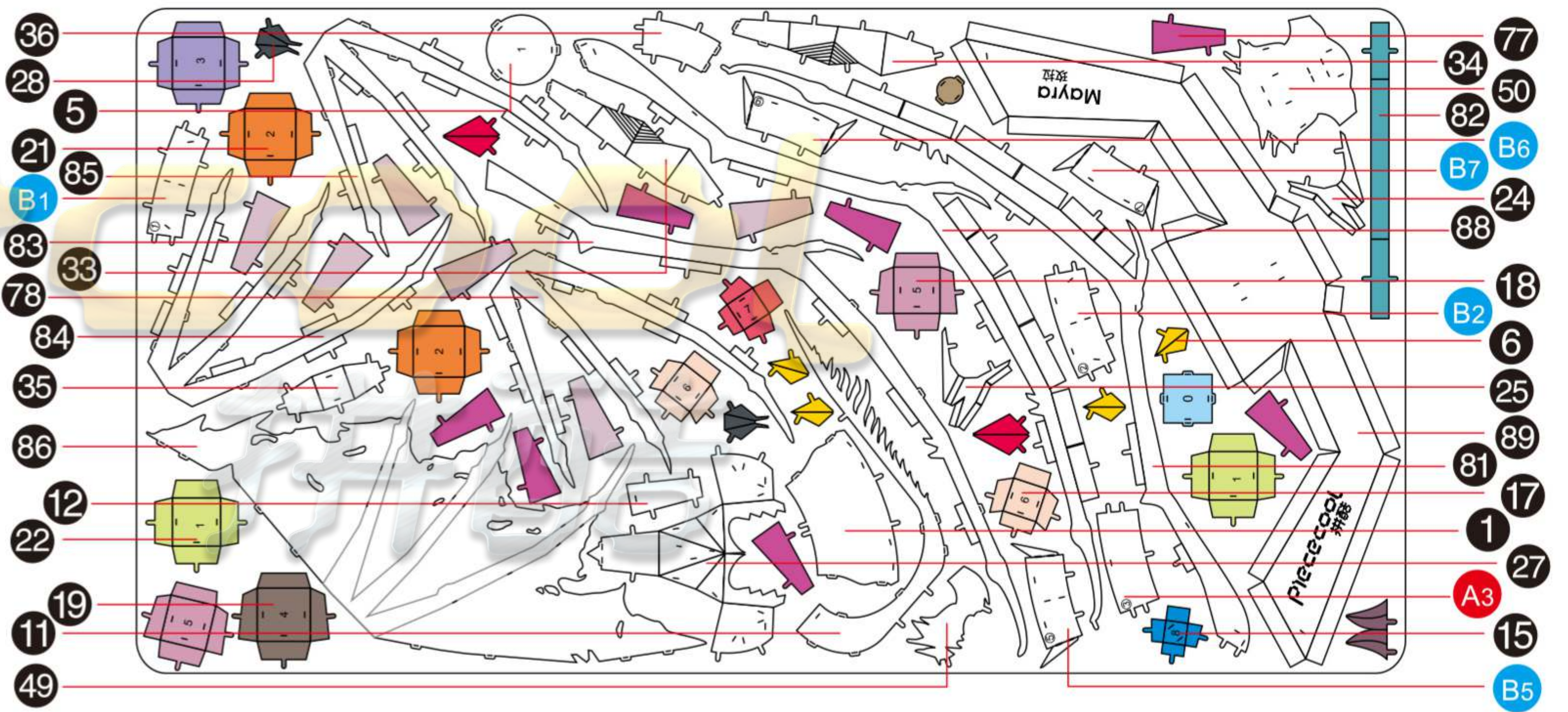
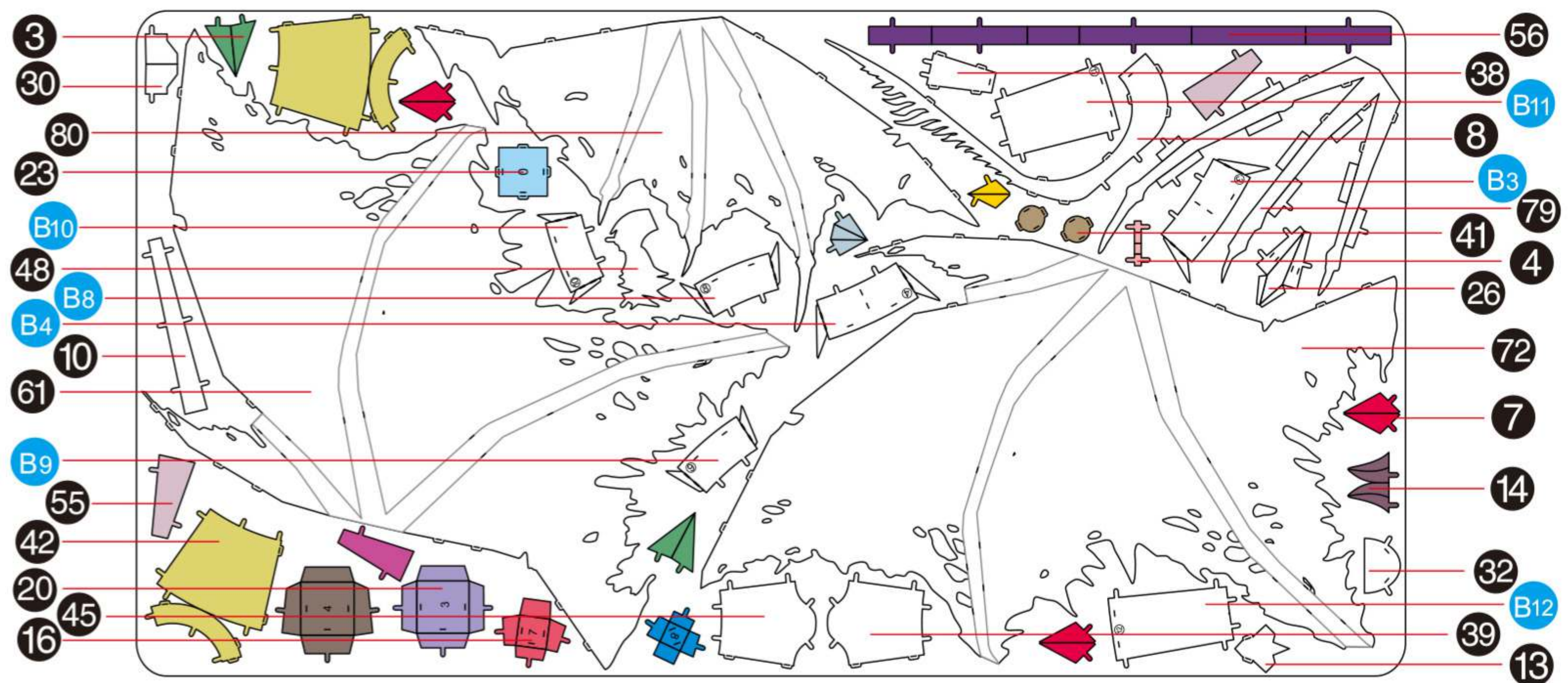

拼装步骤

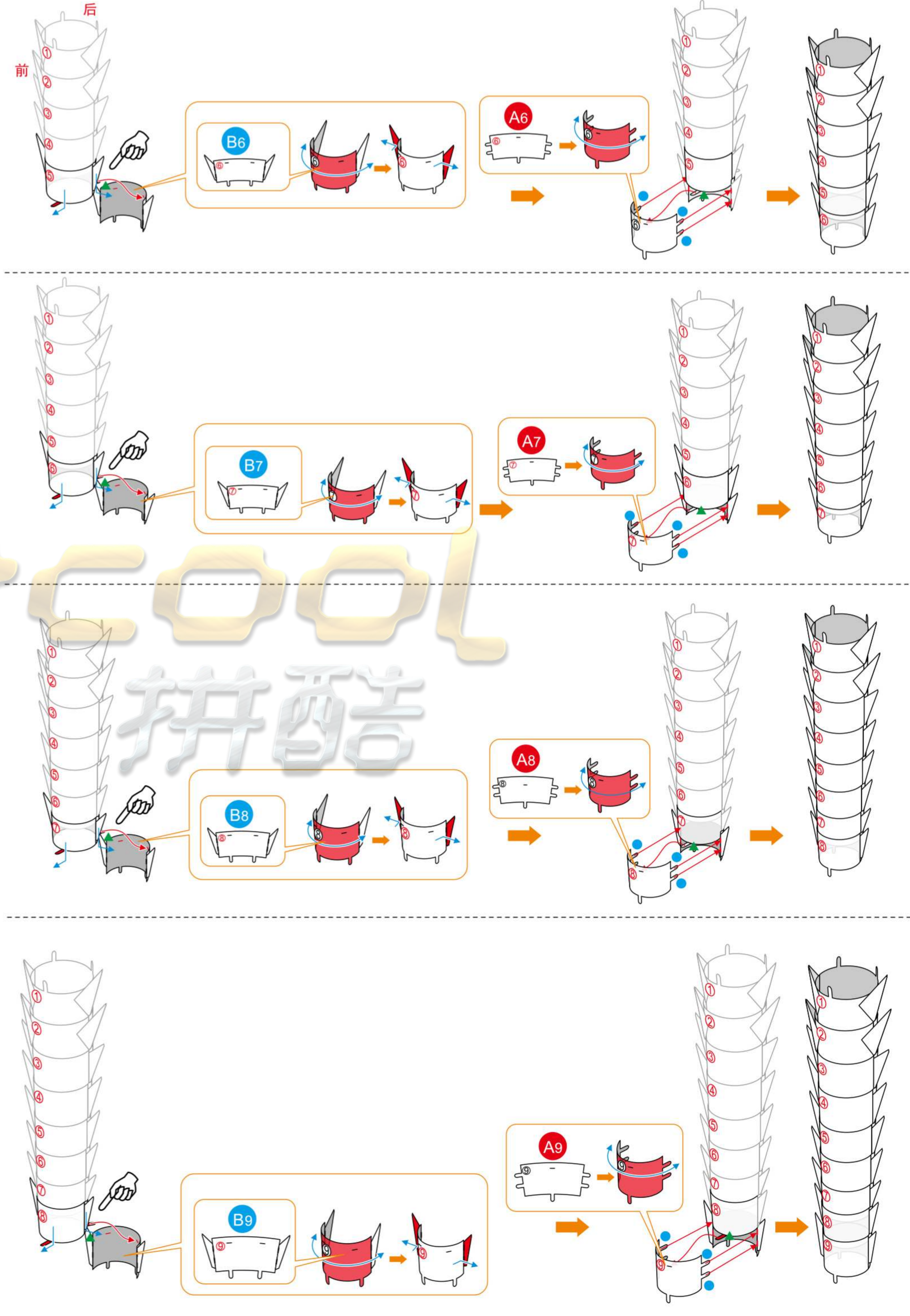
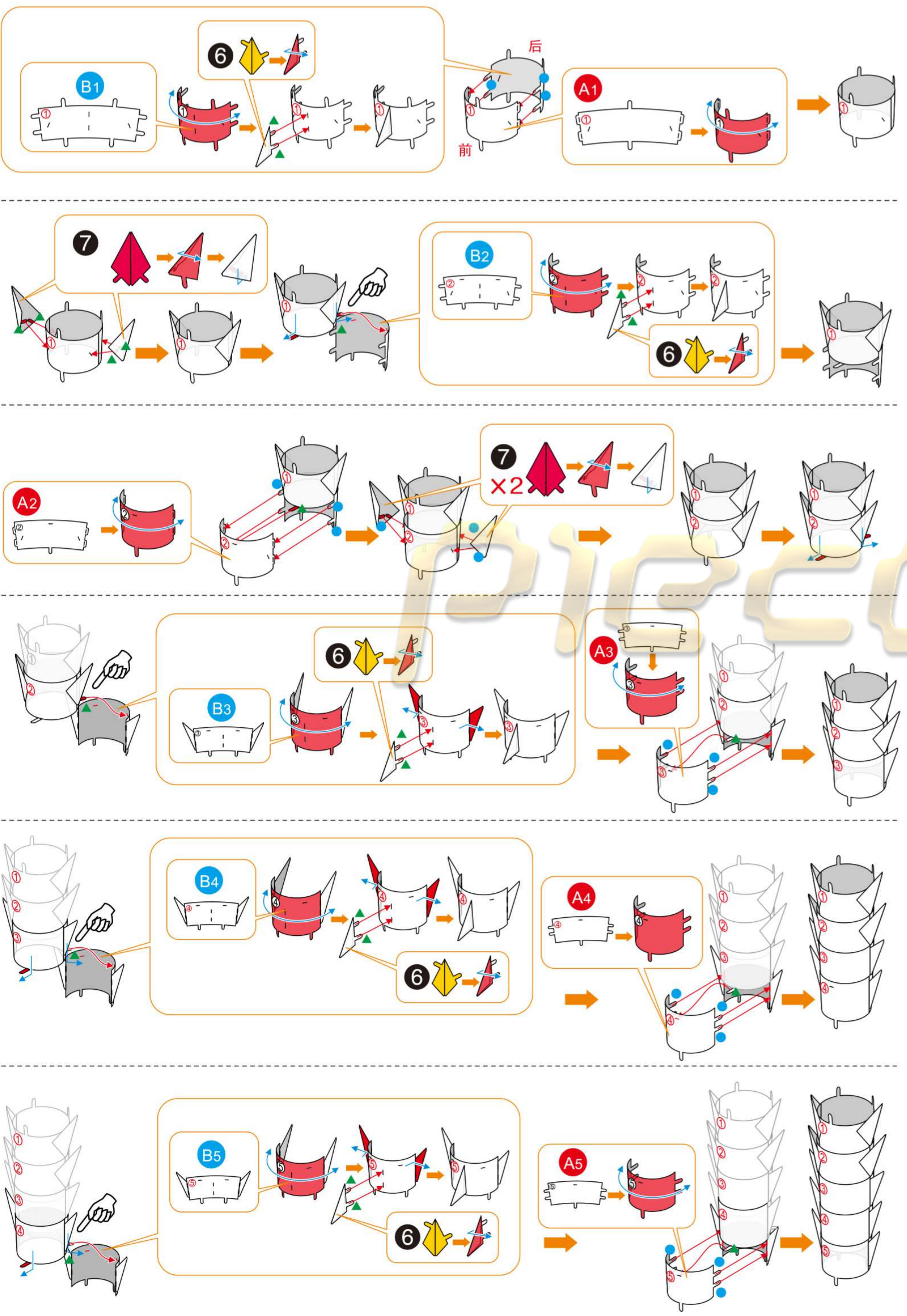
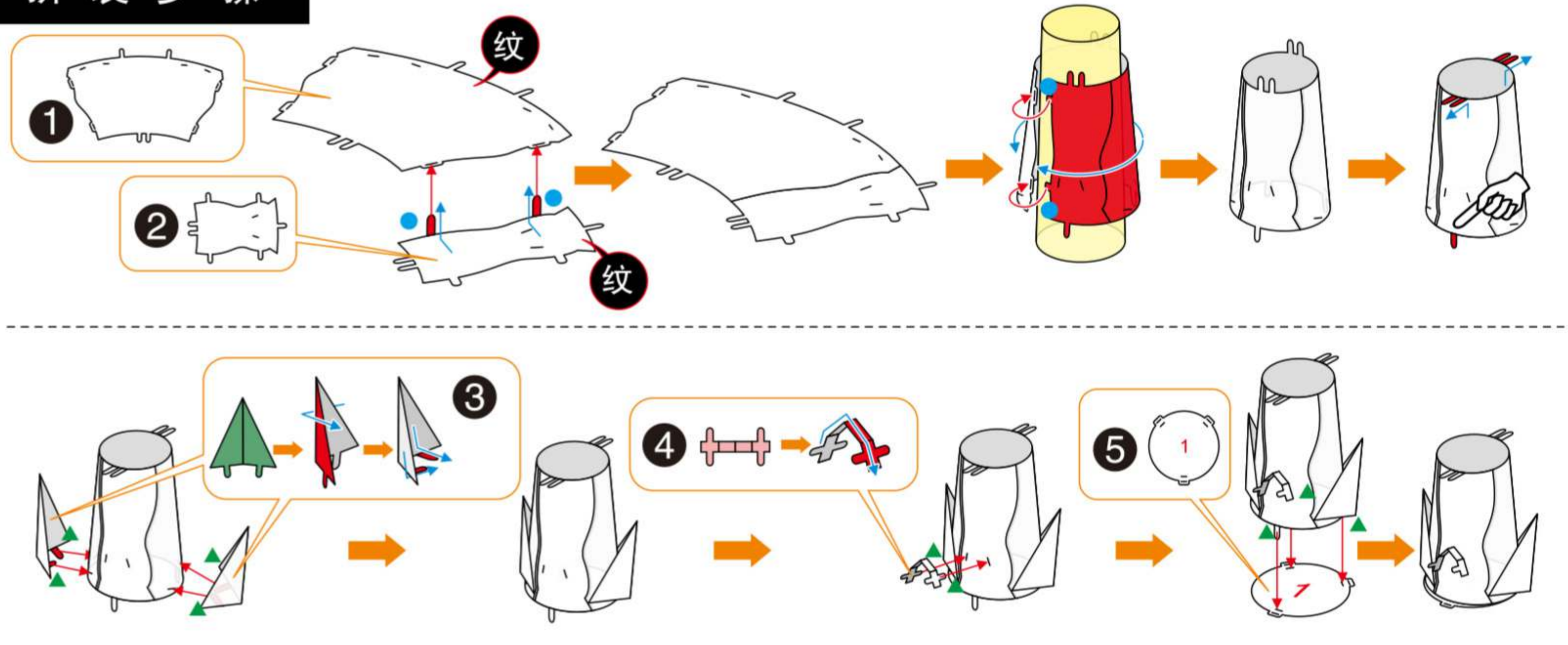

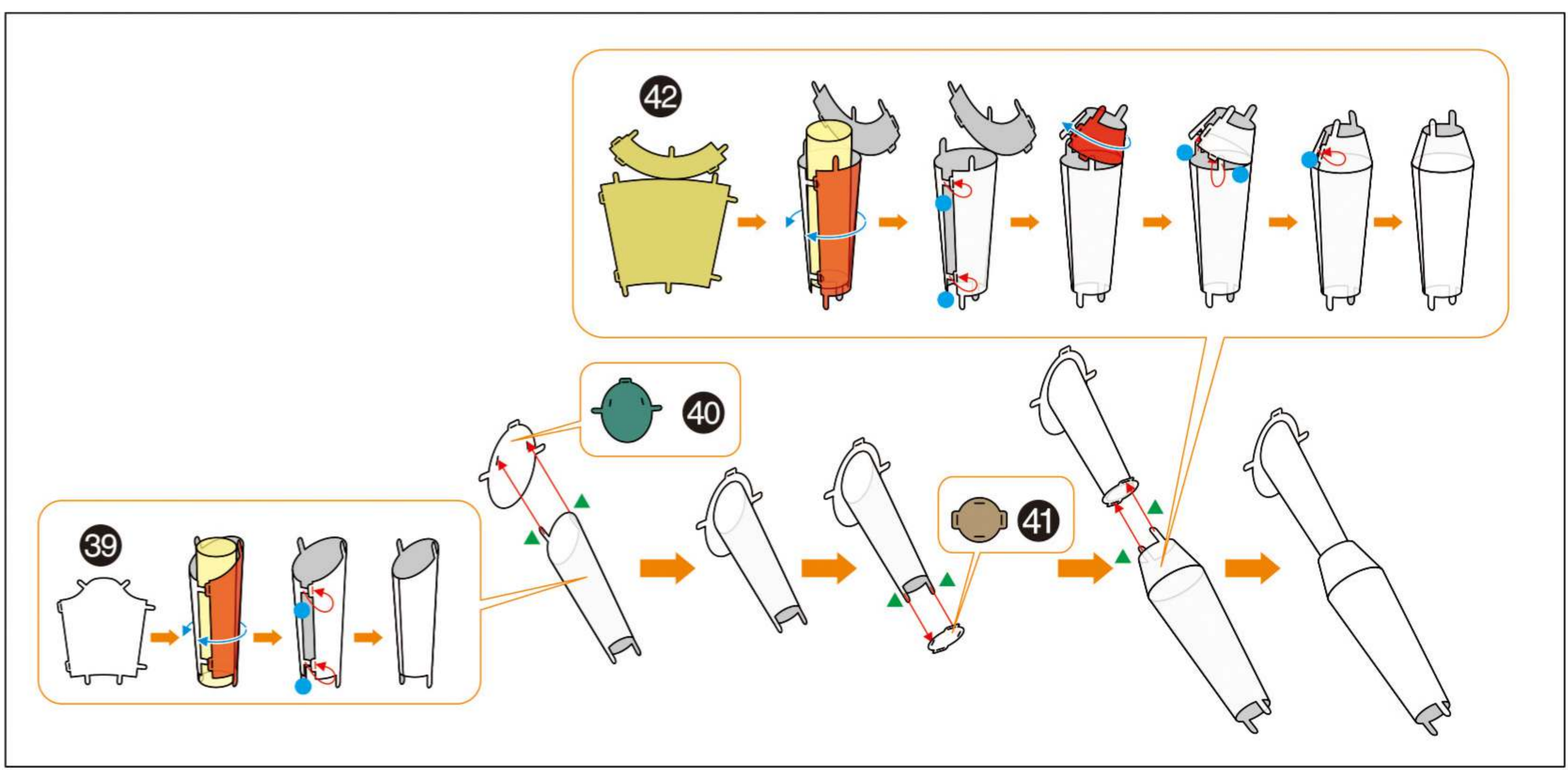
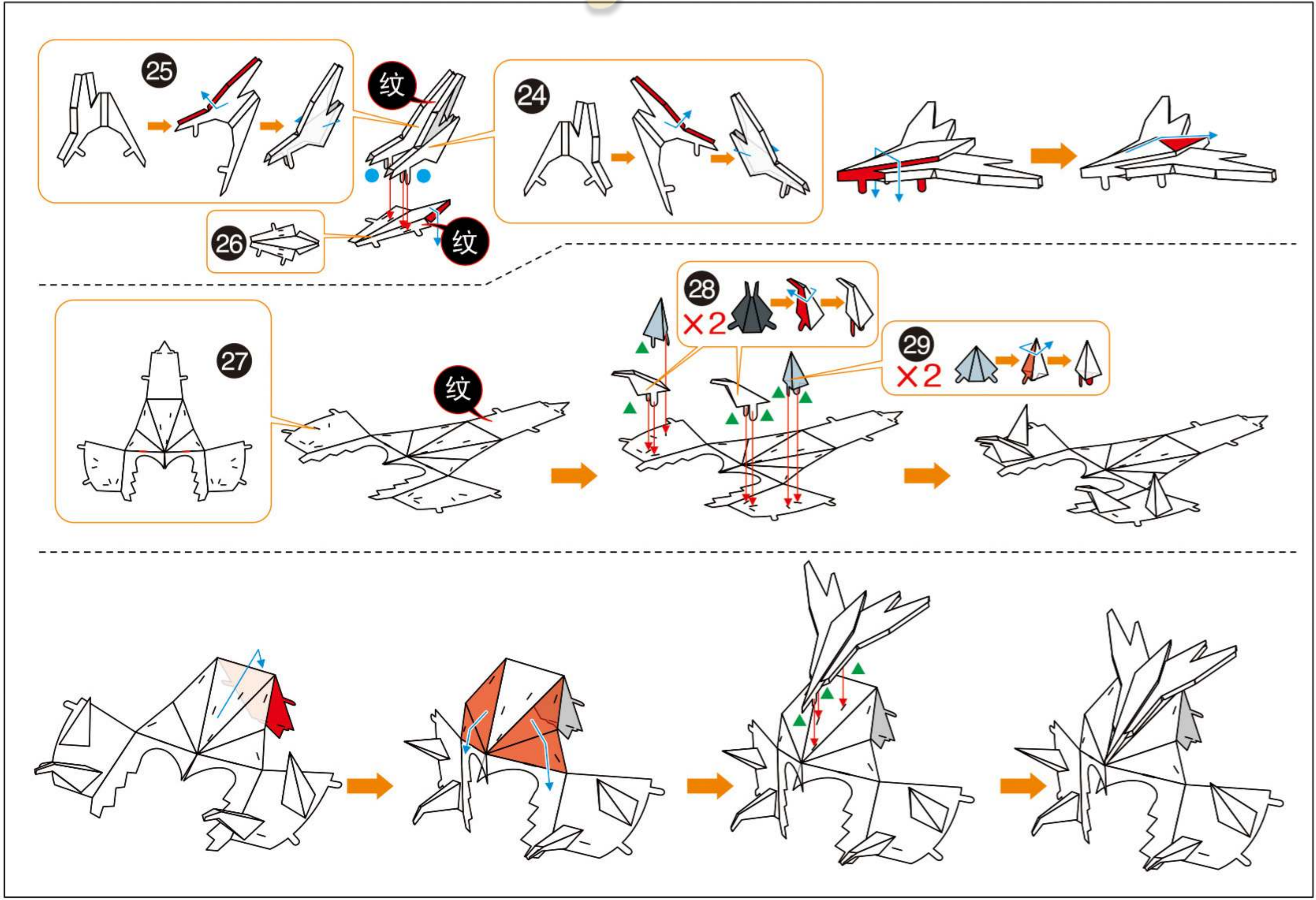
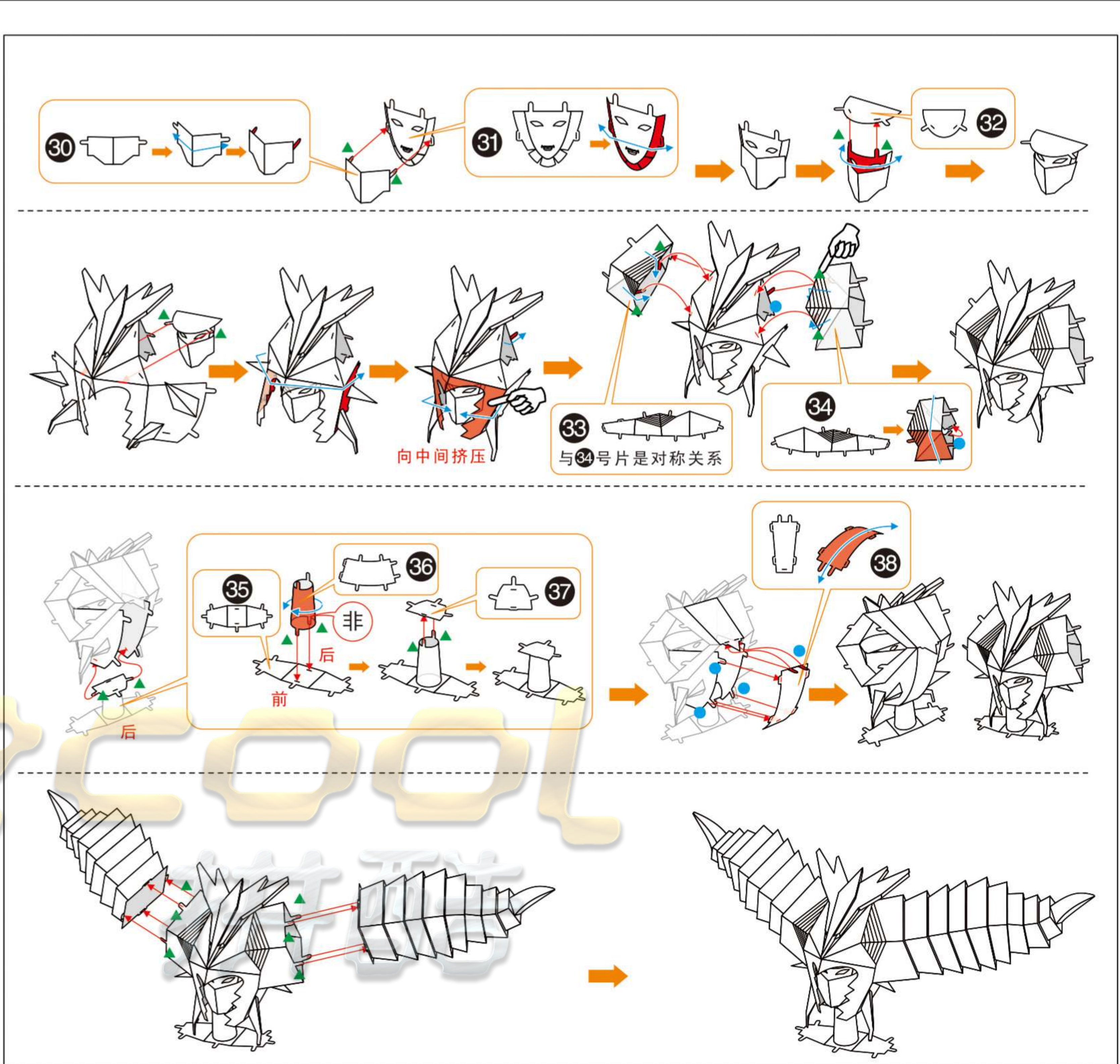
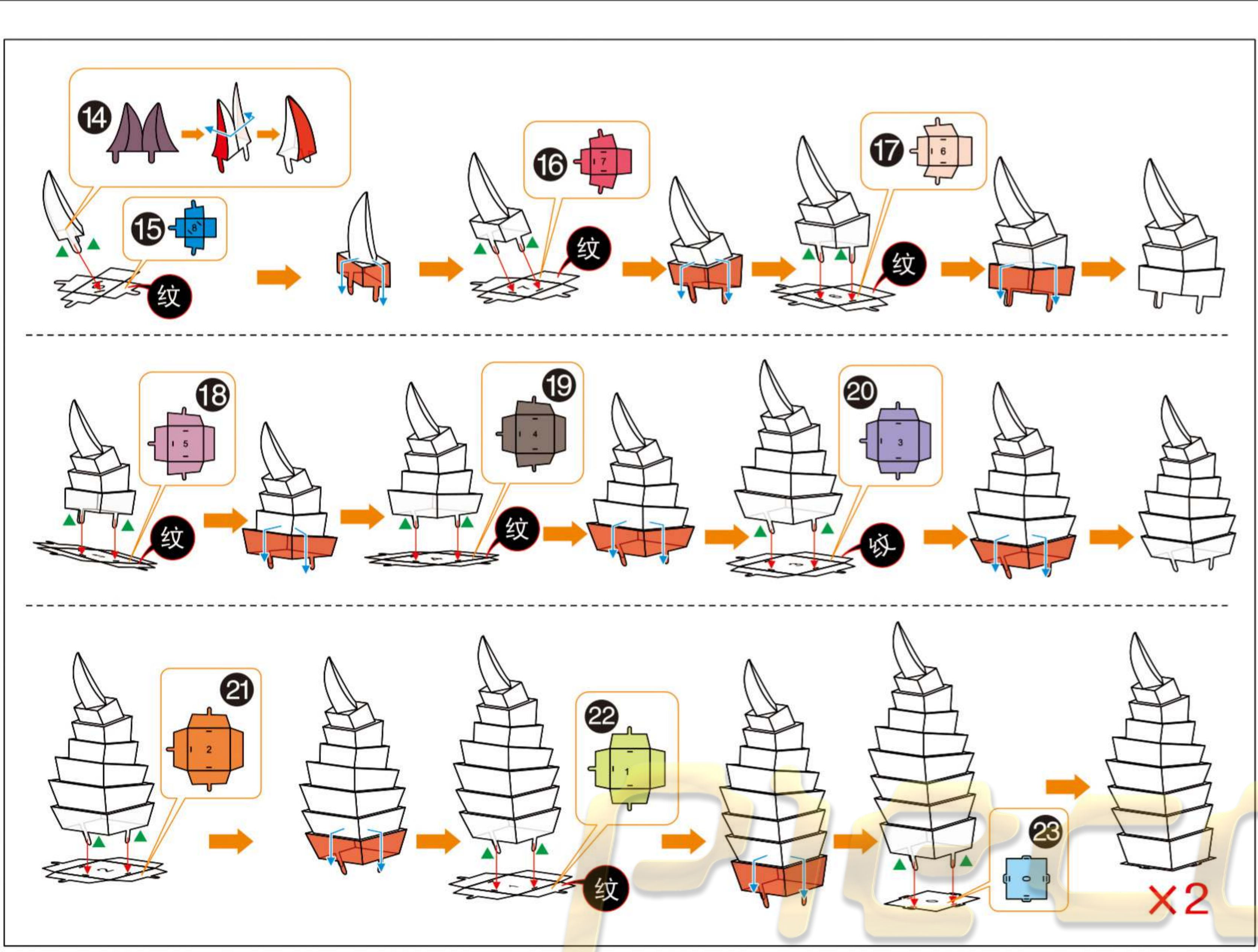
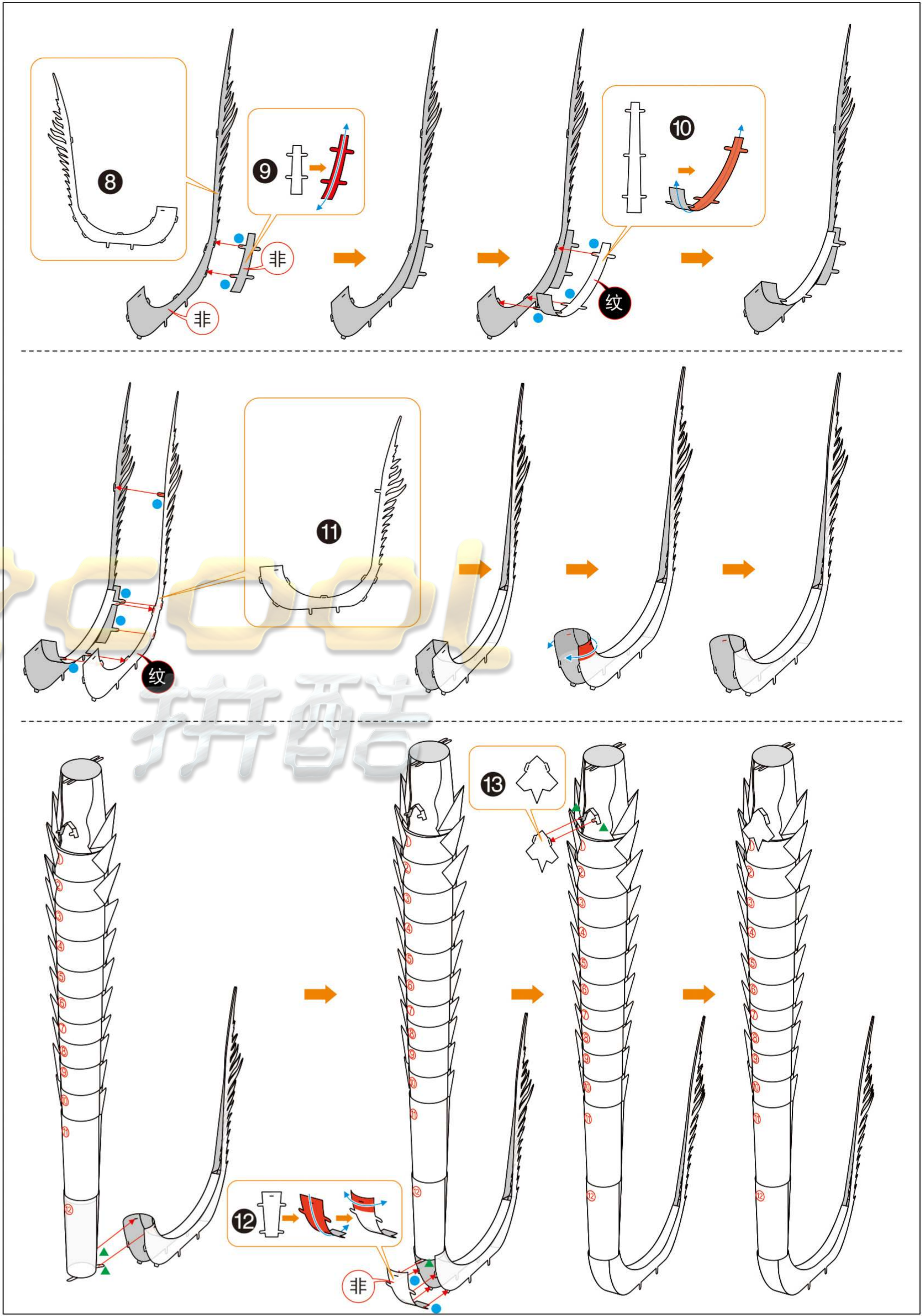
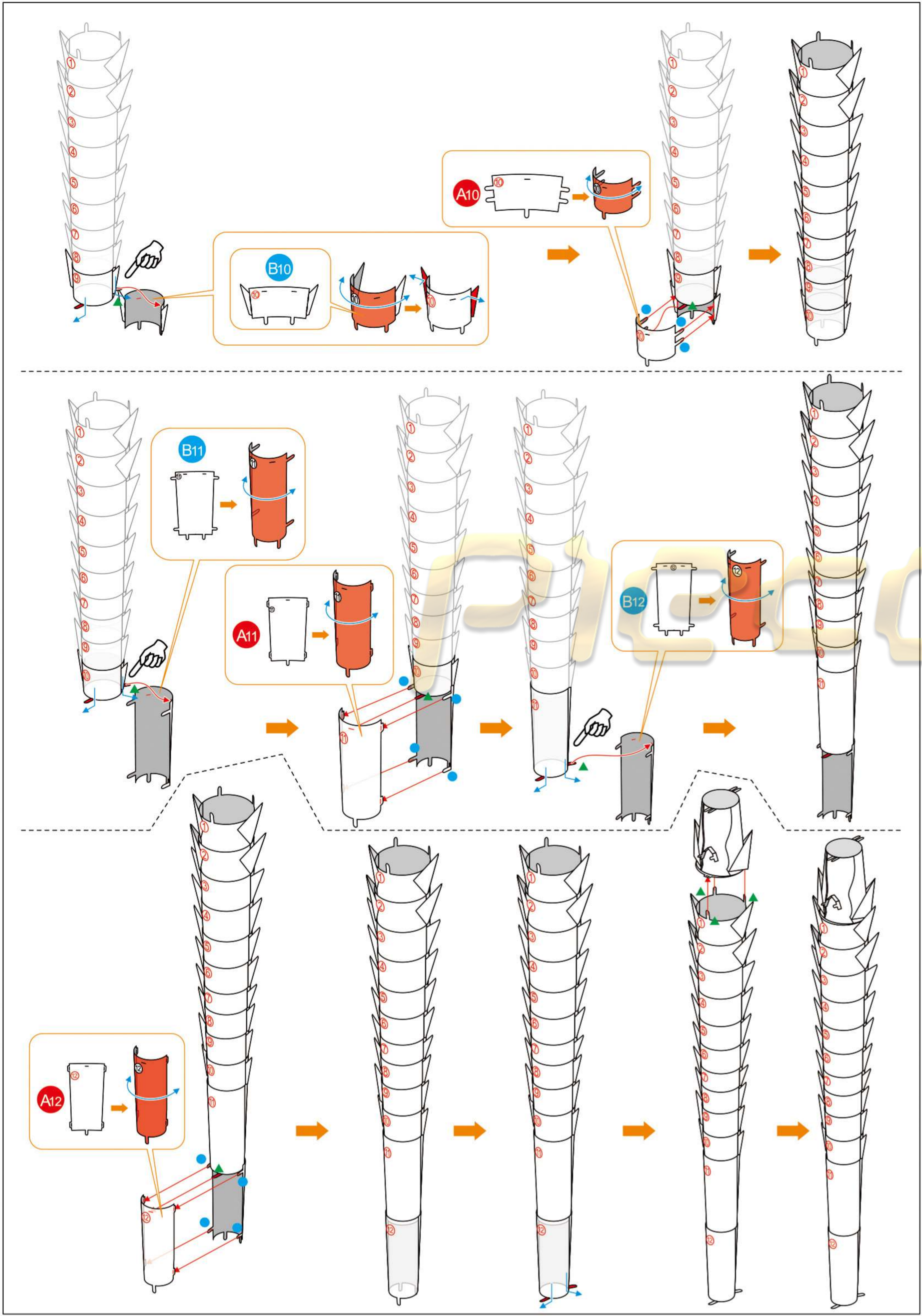

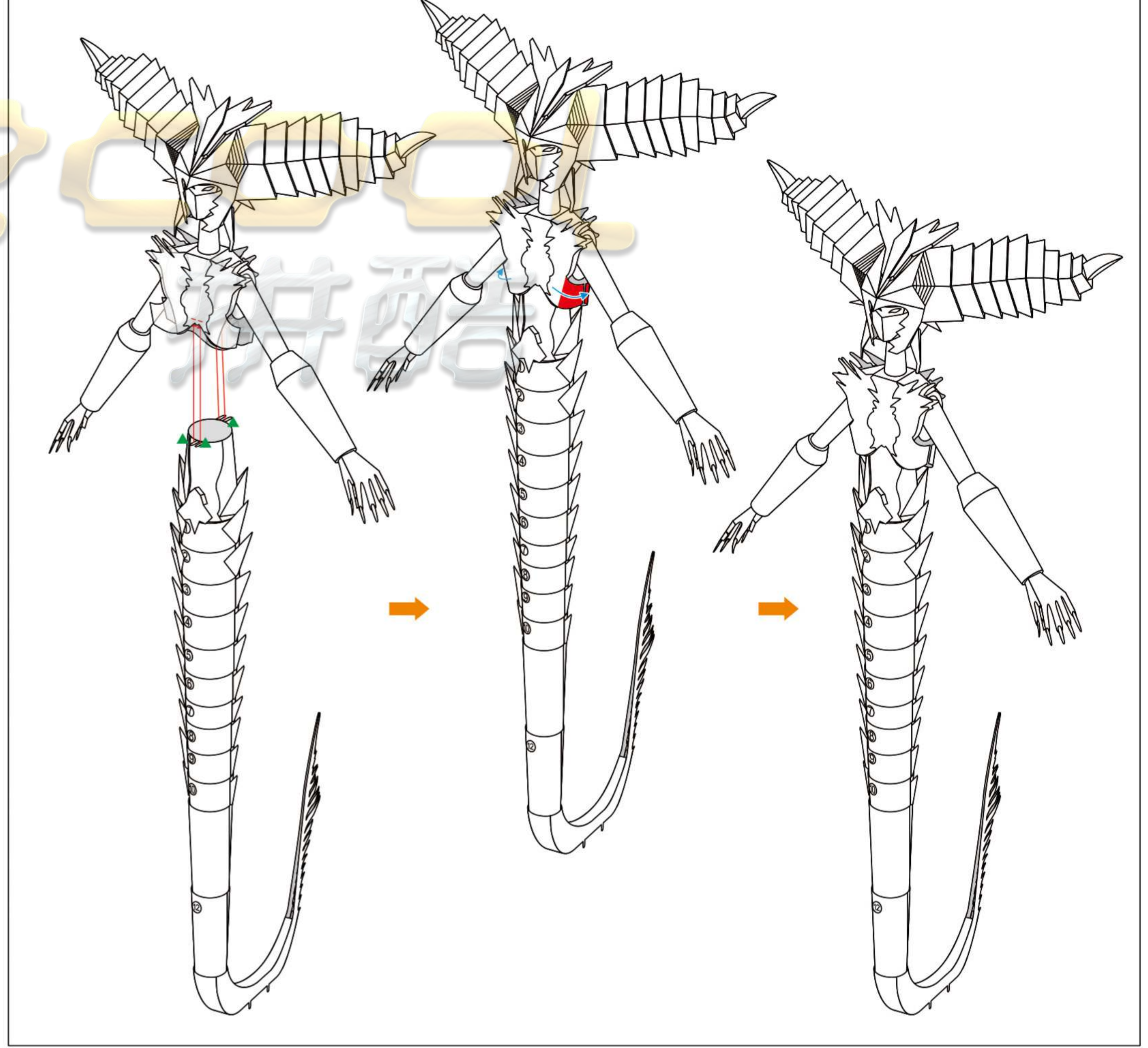
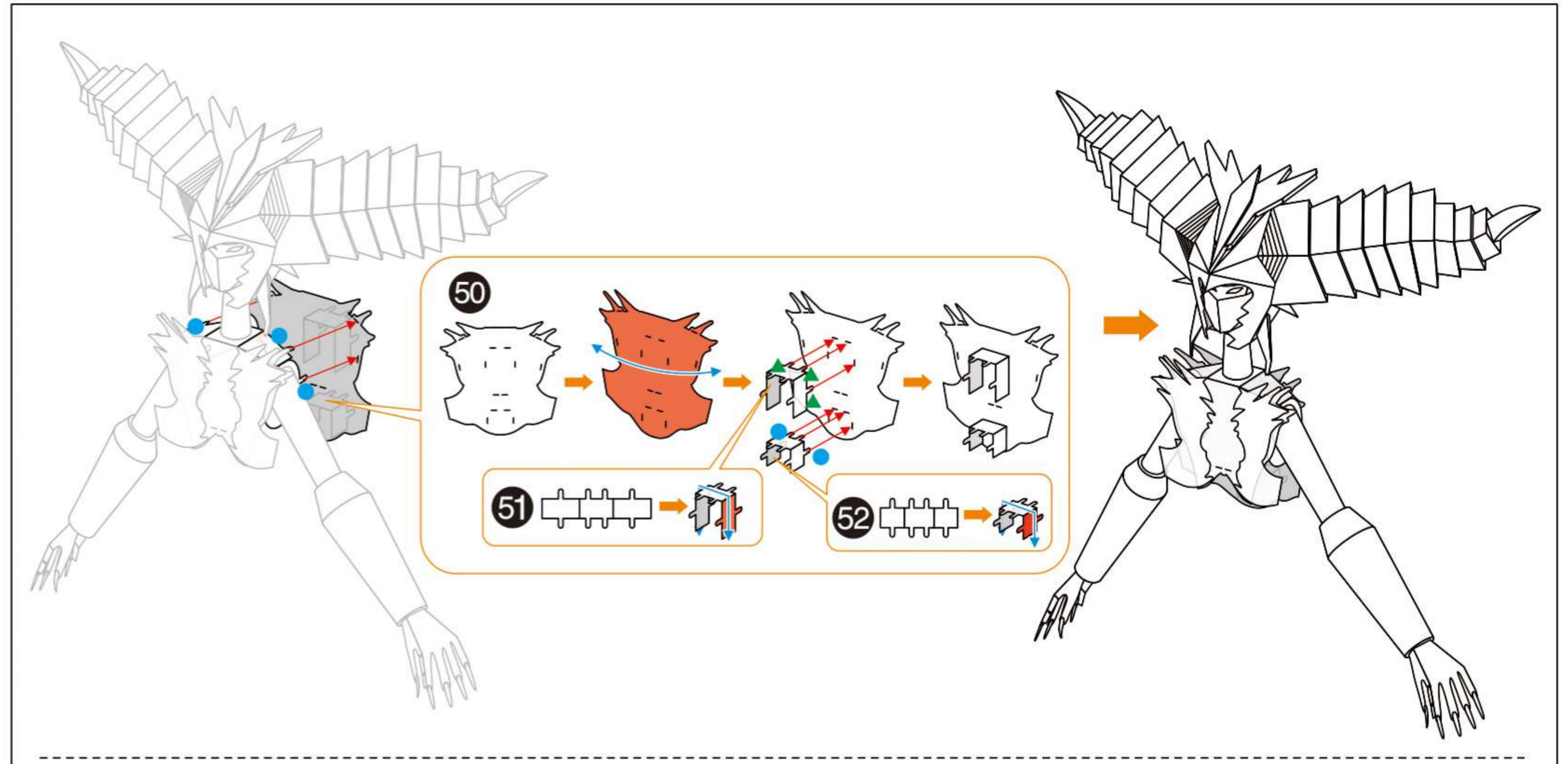
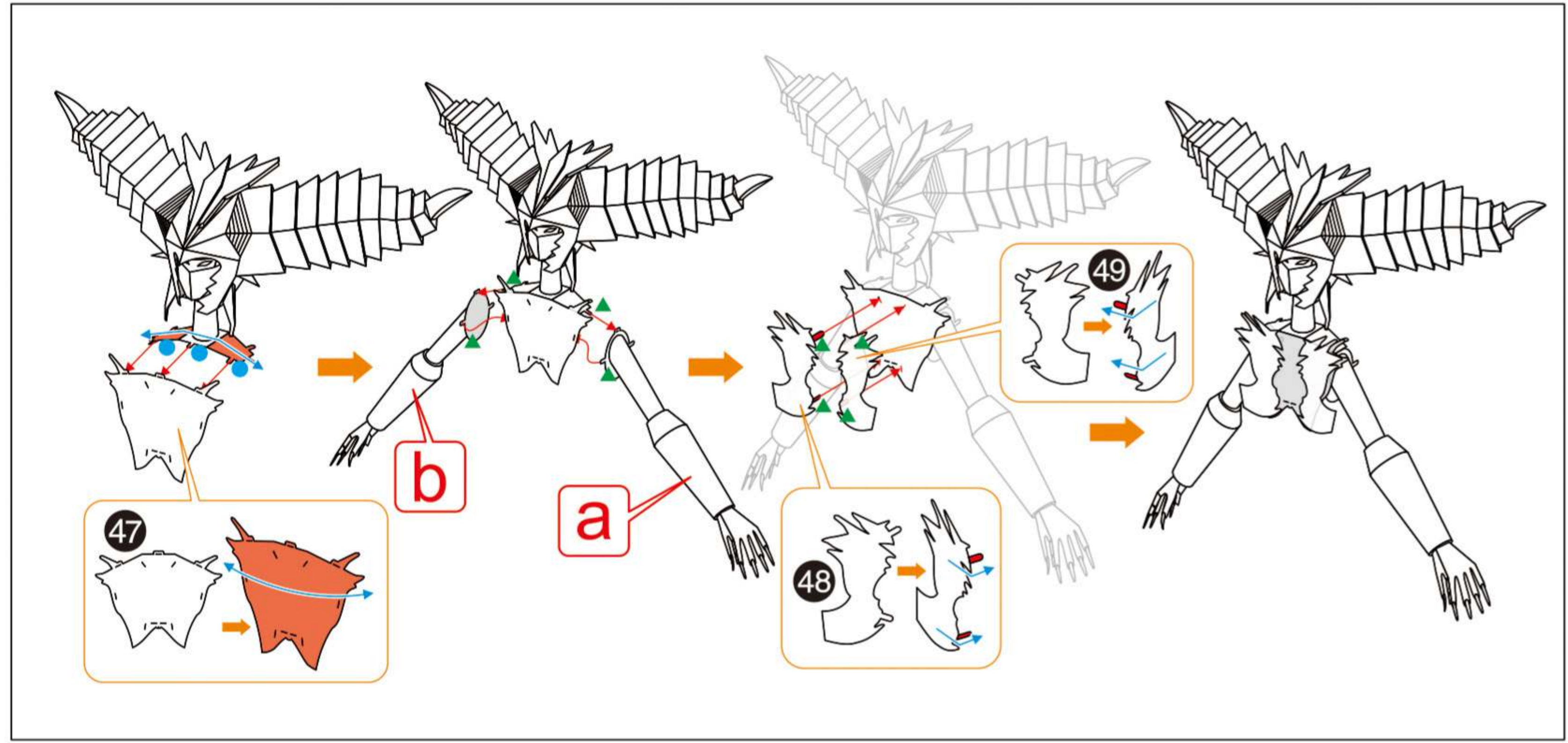
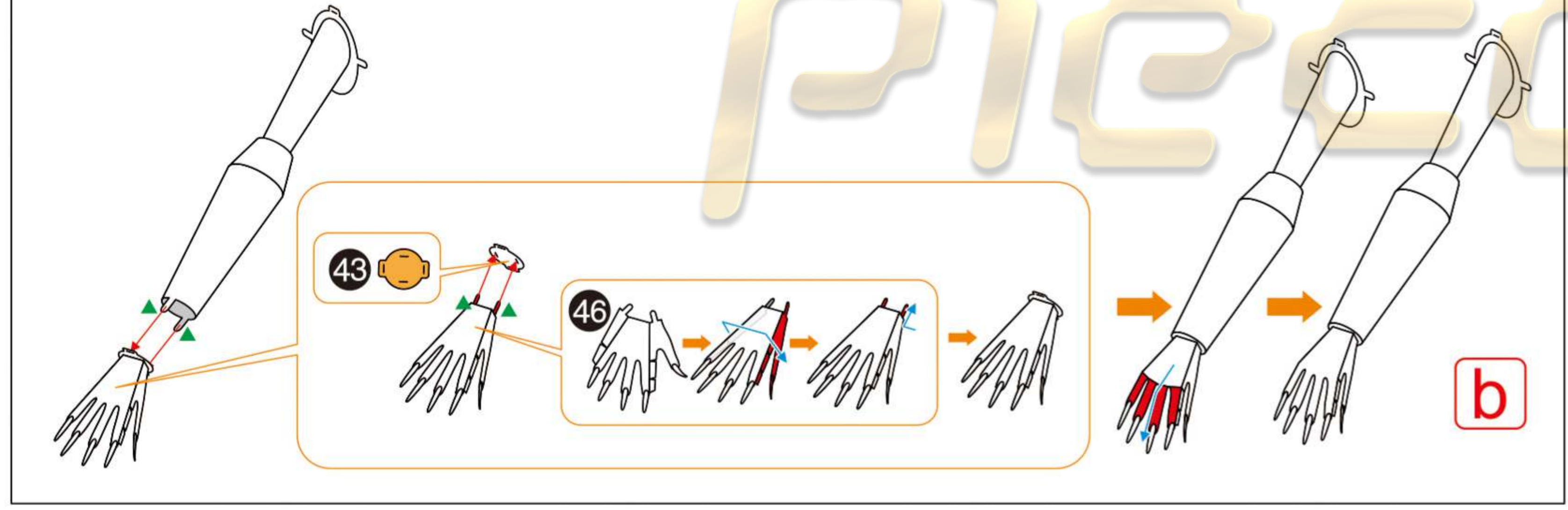
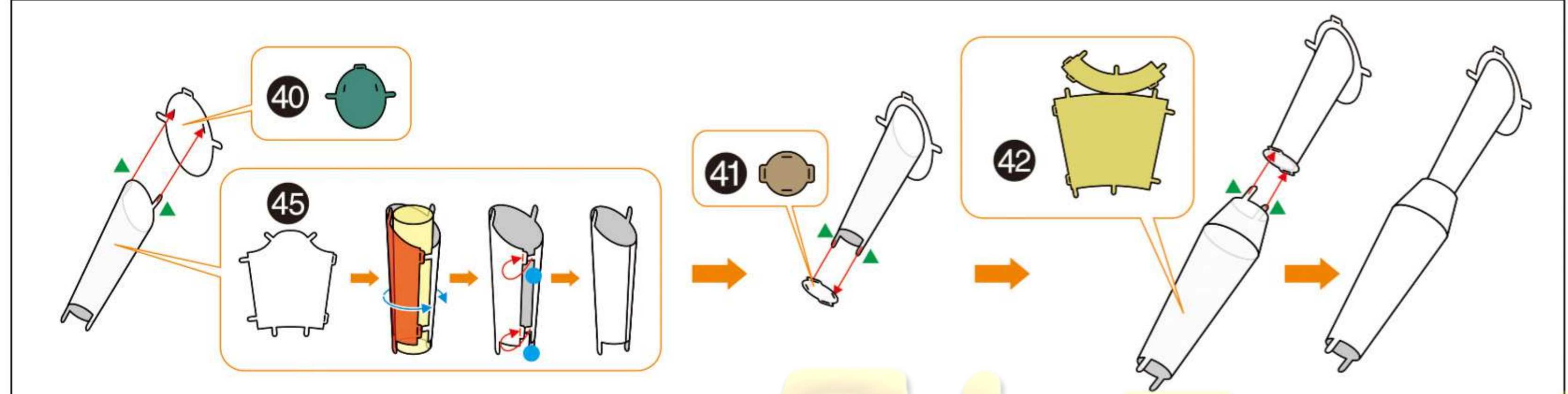
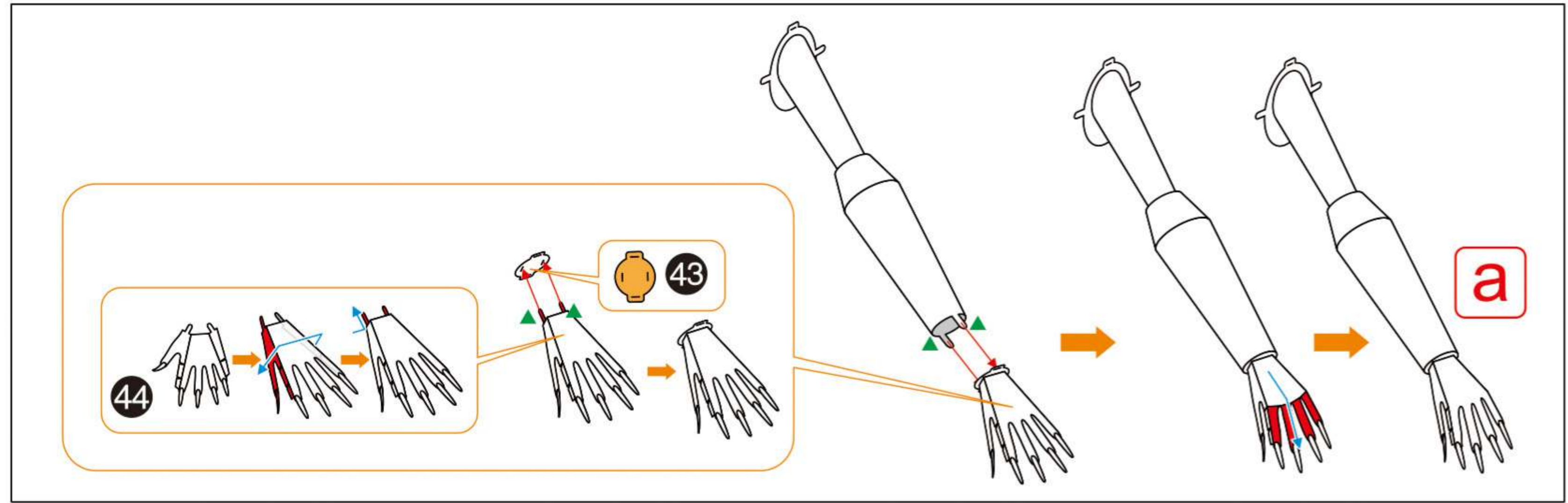

9 10
11 12

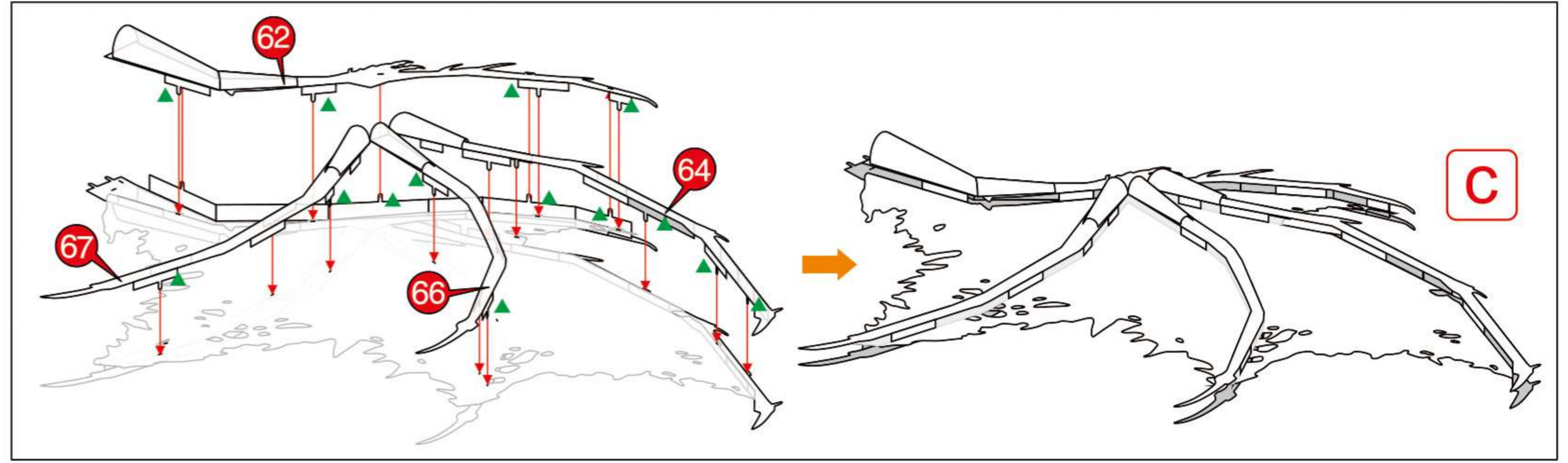
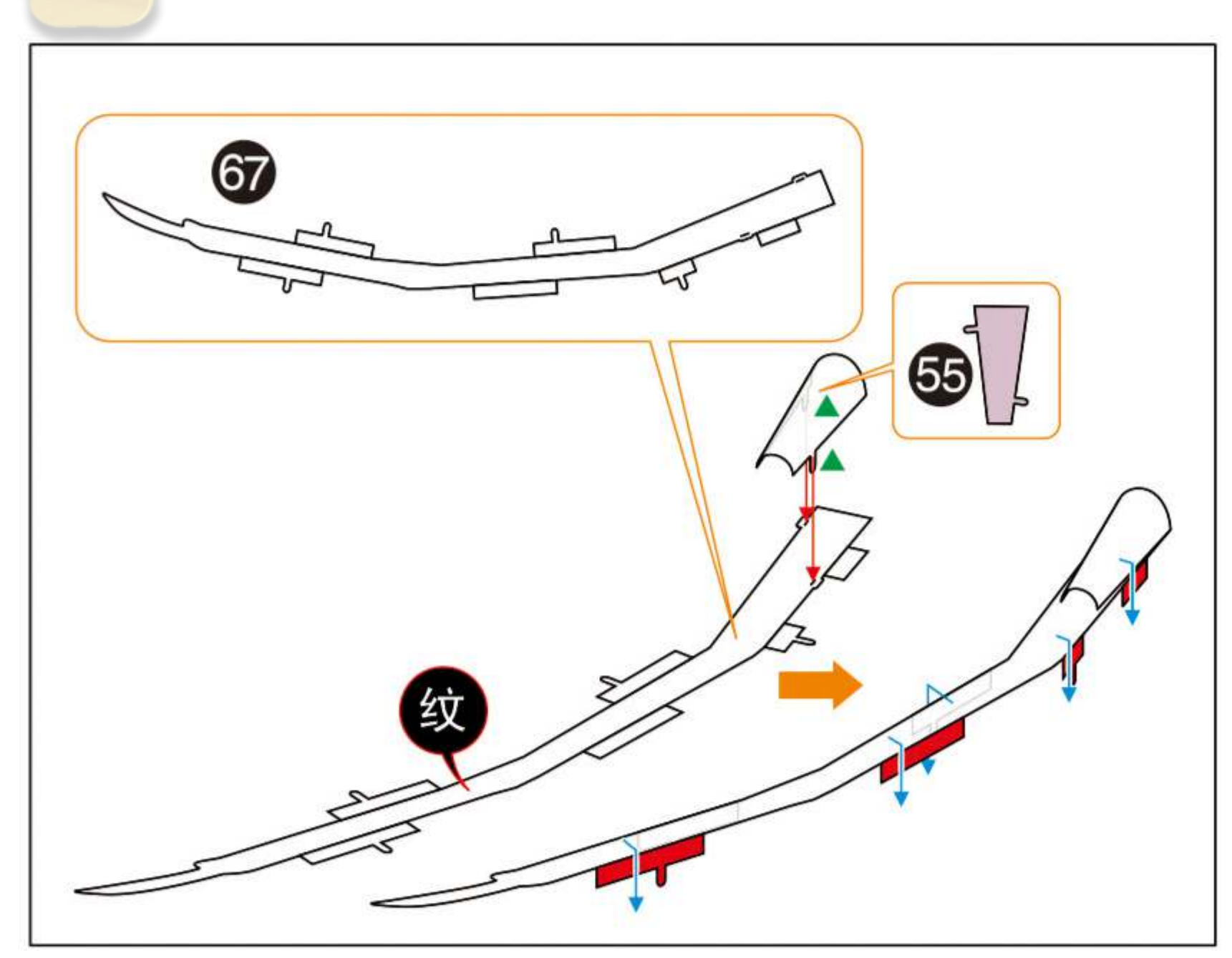
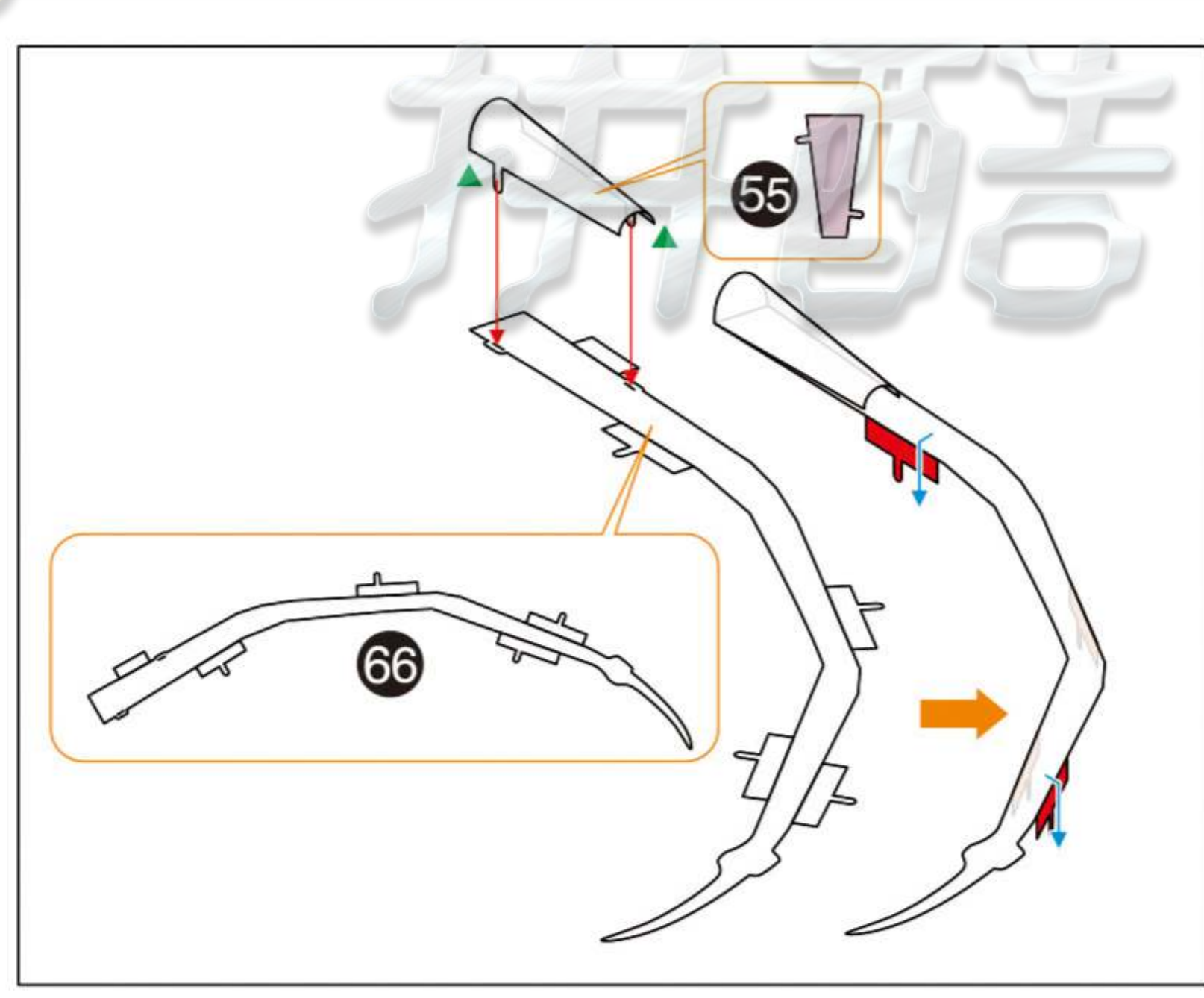
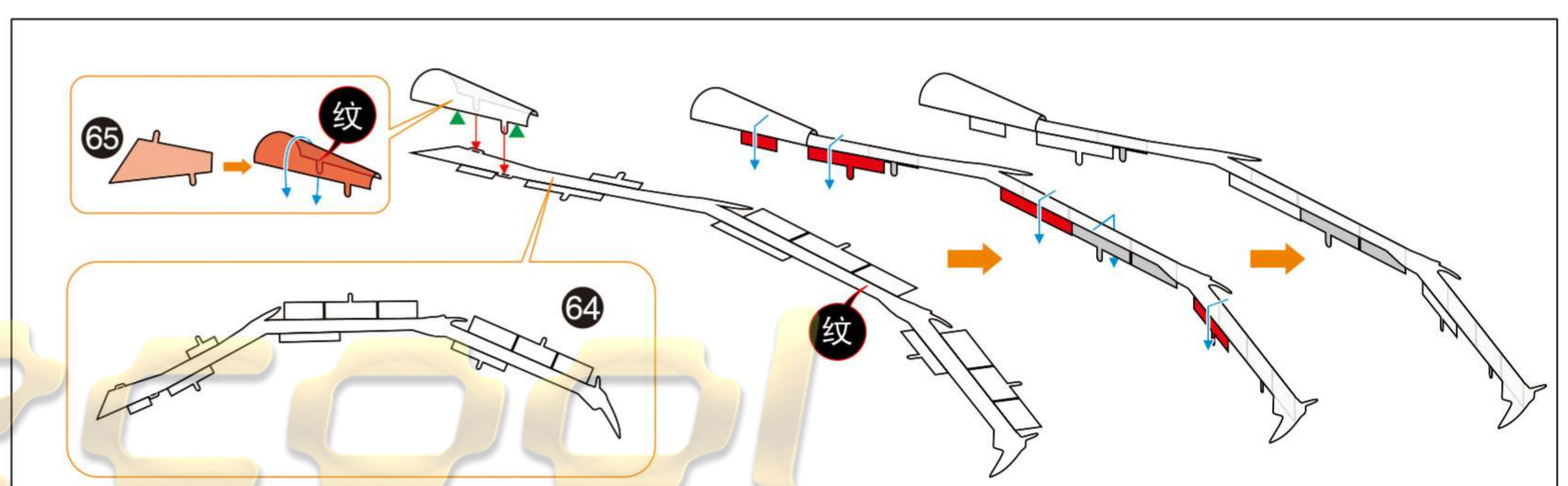
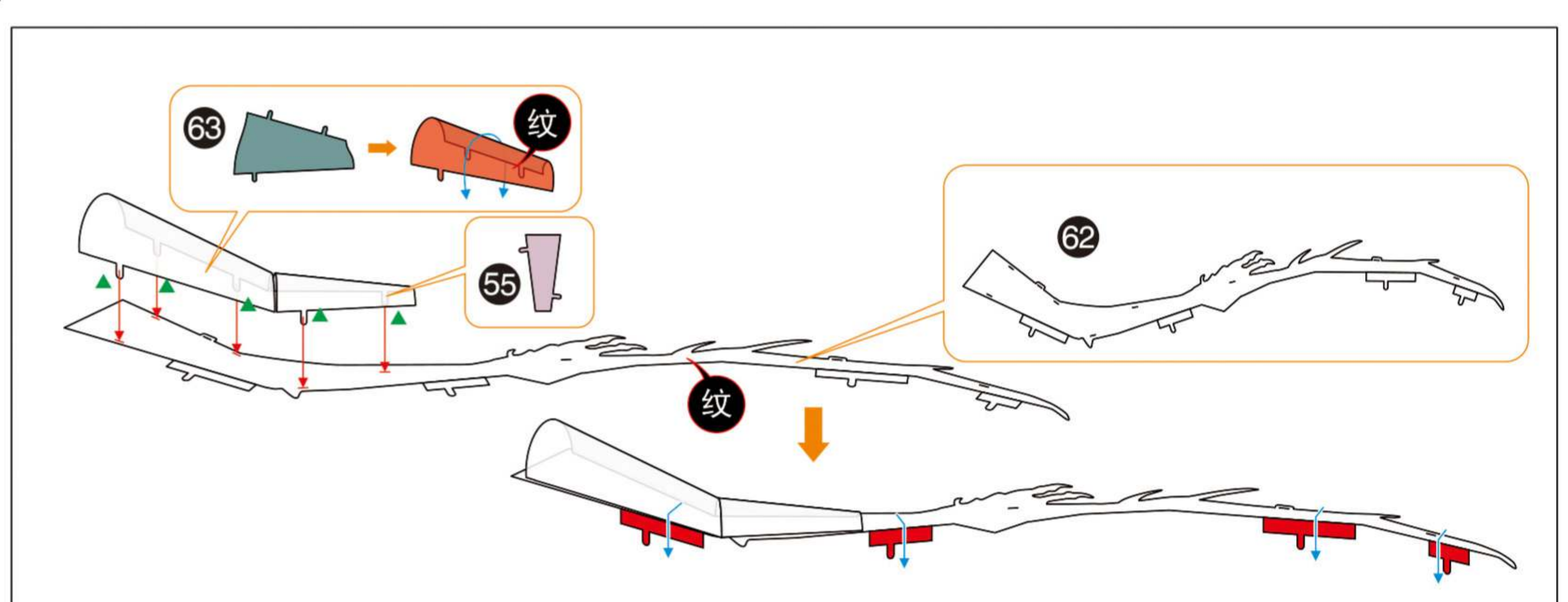
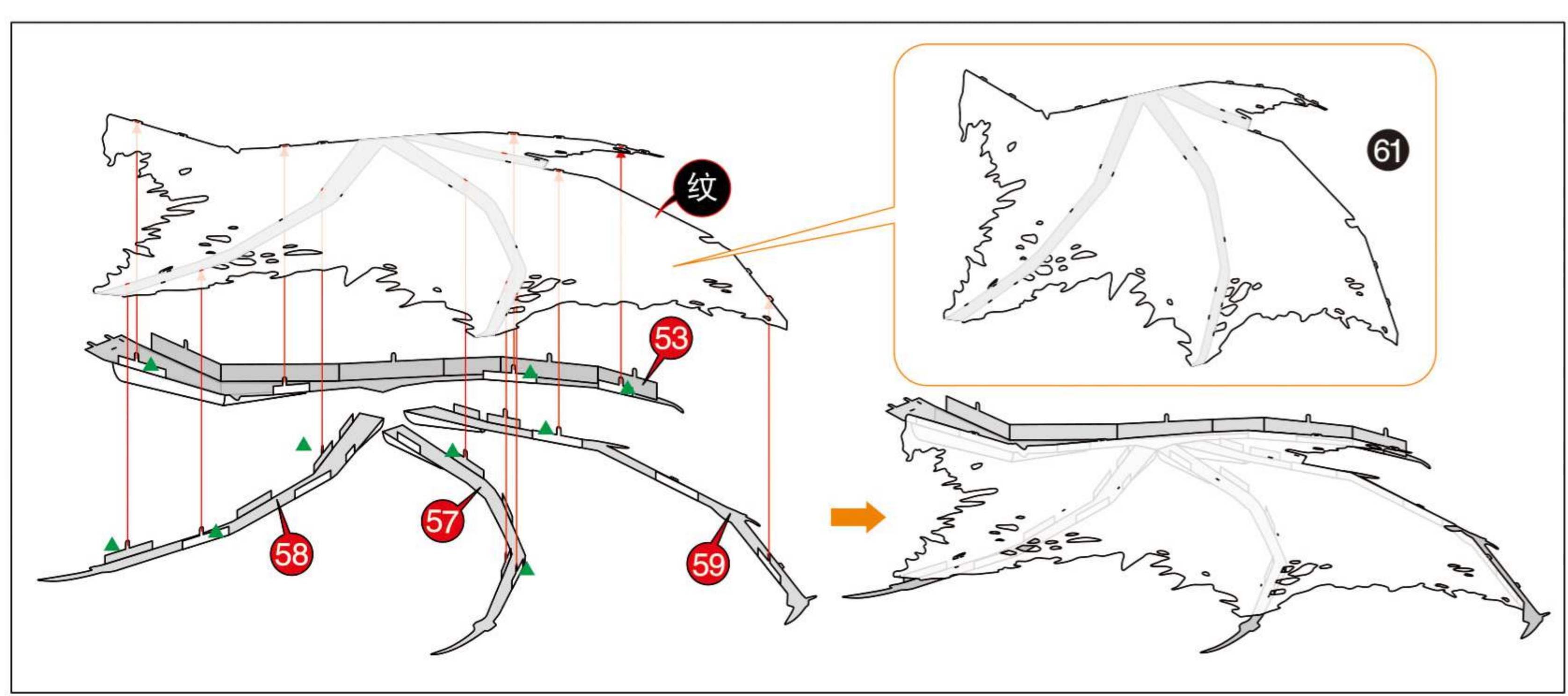
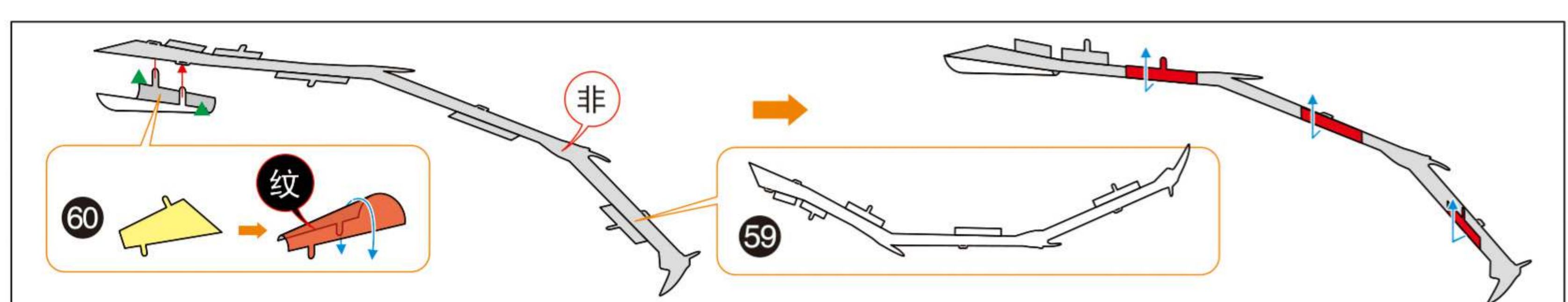
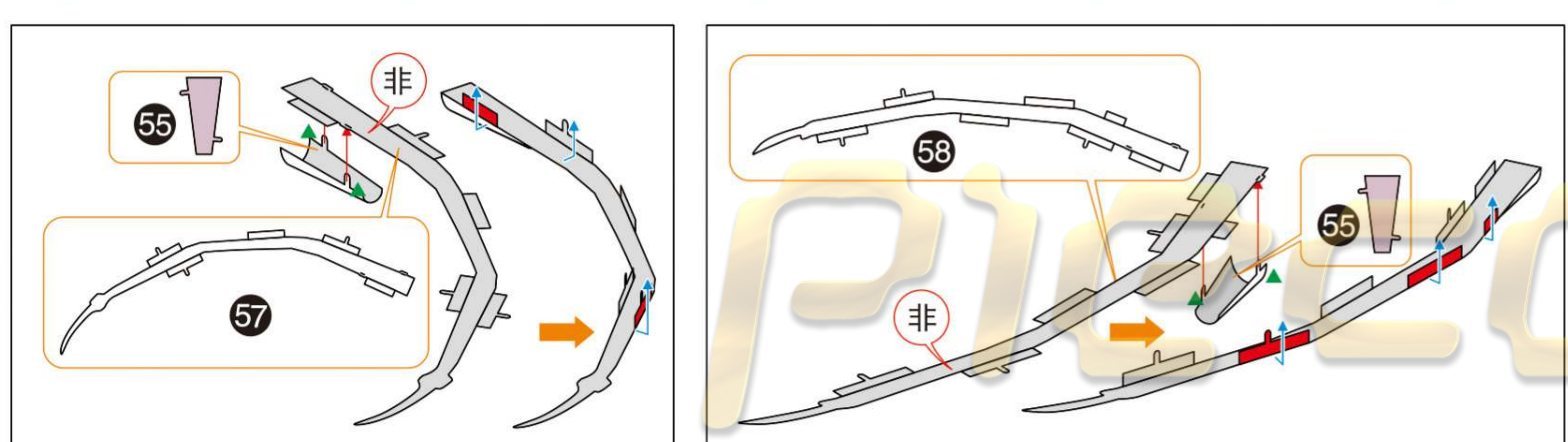
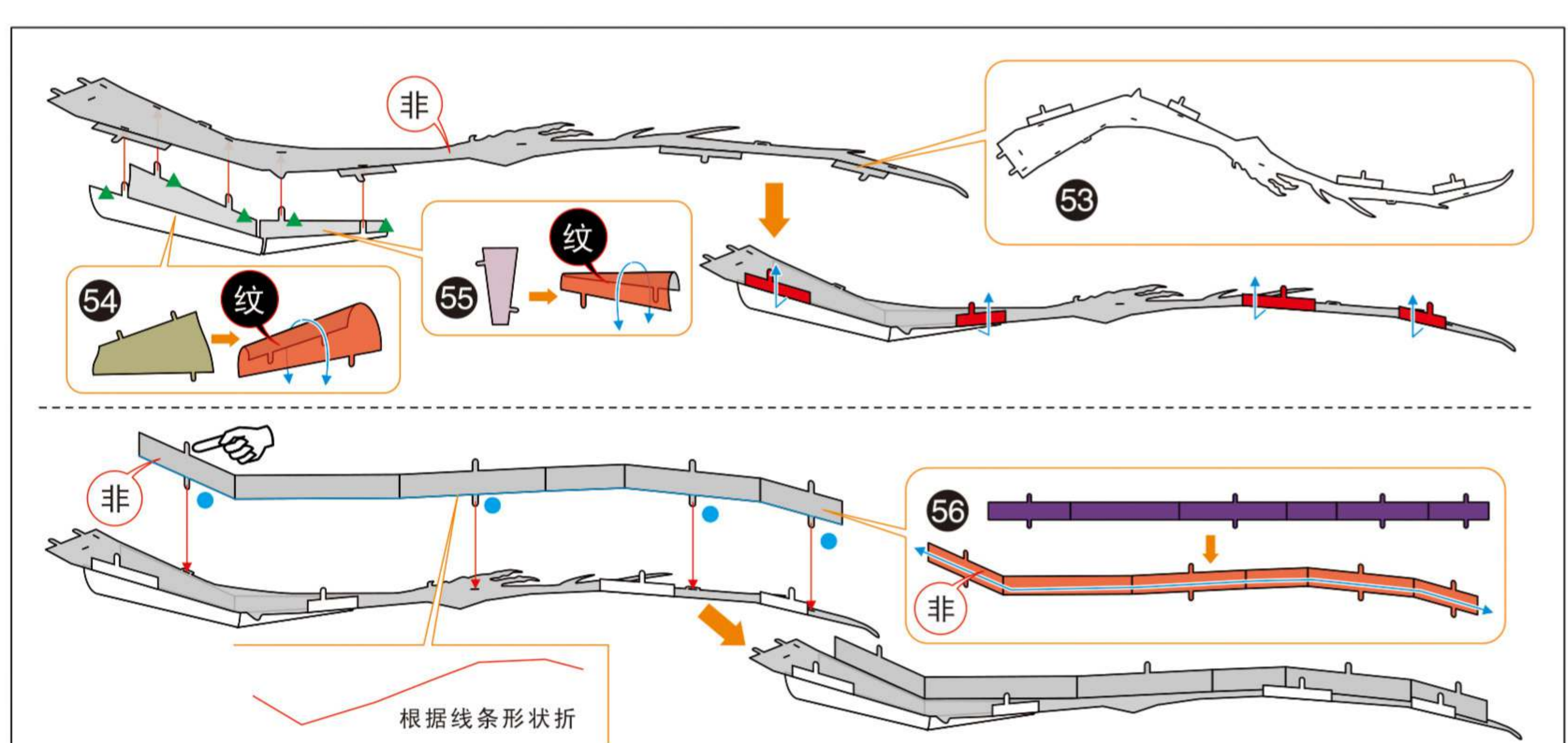

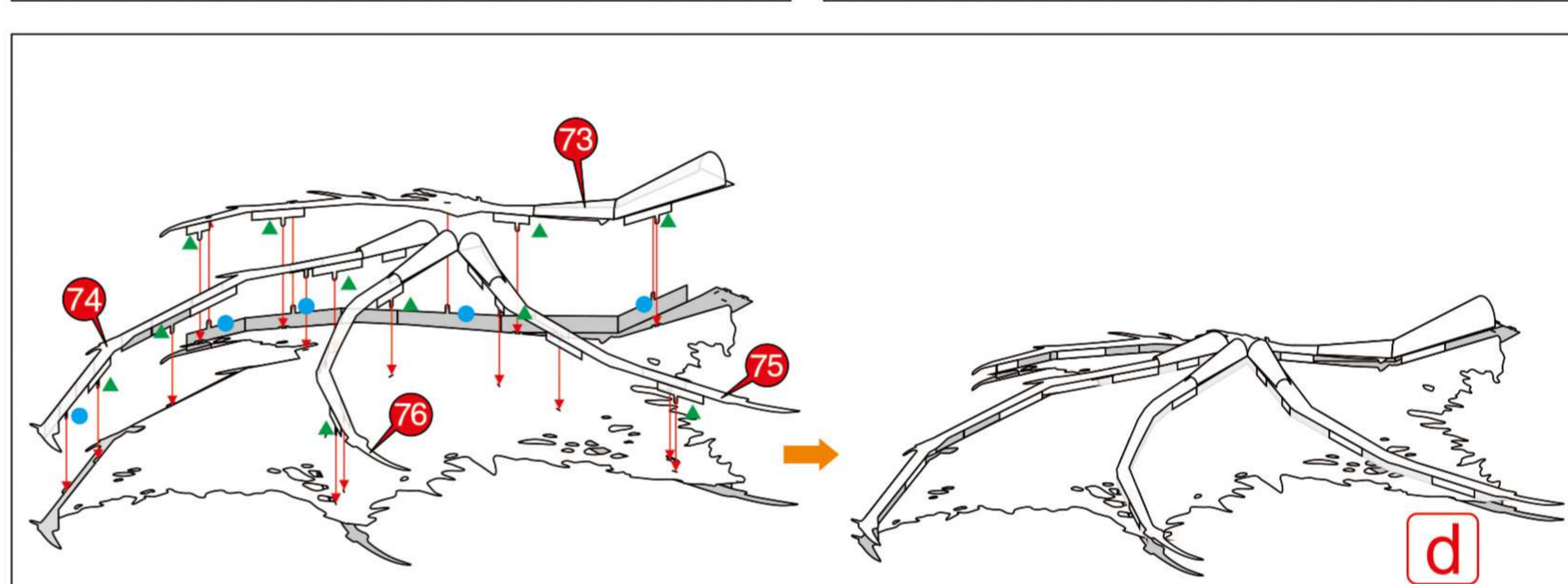
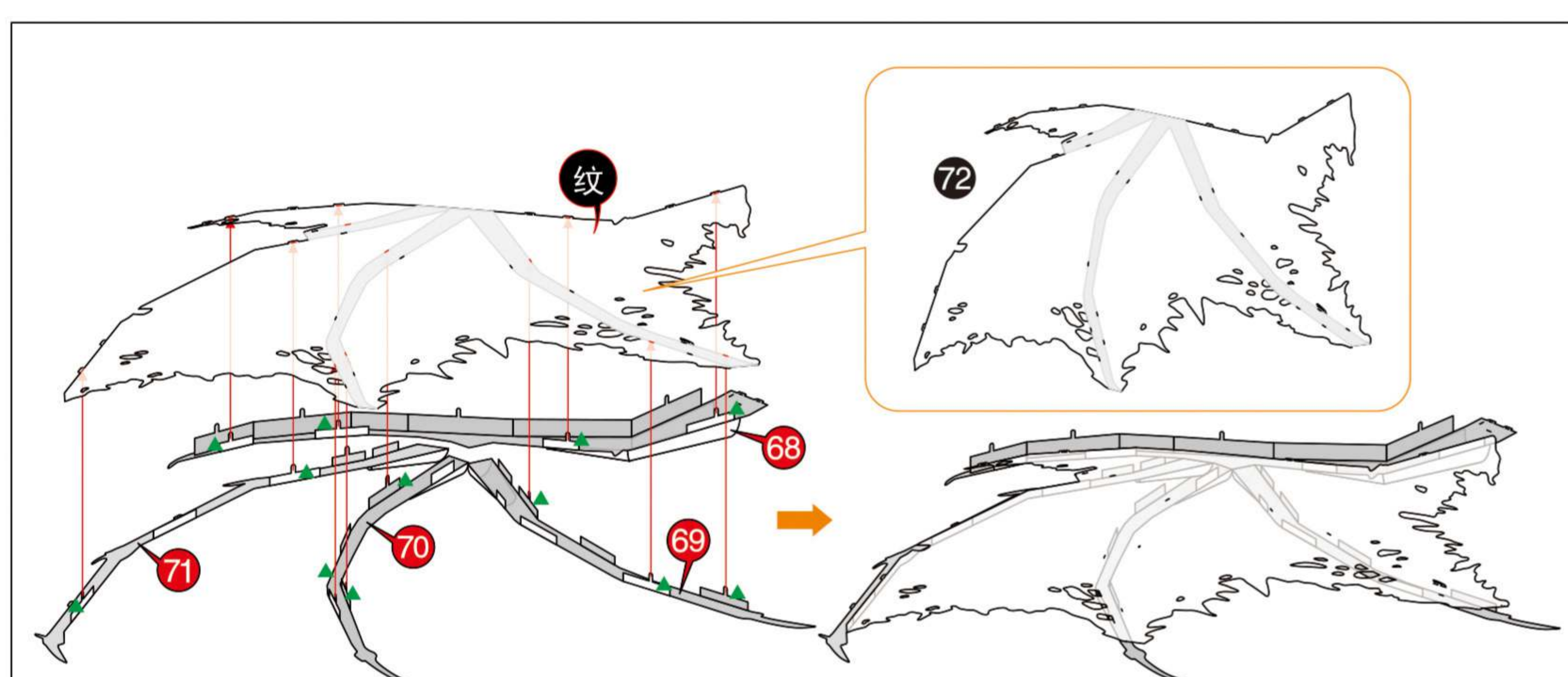
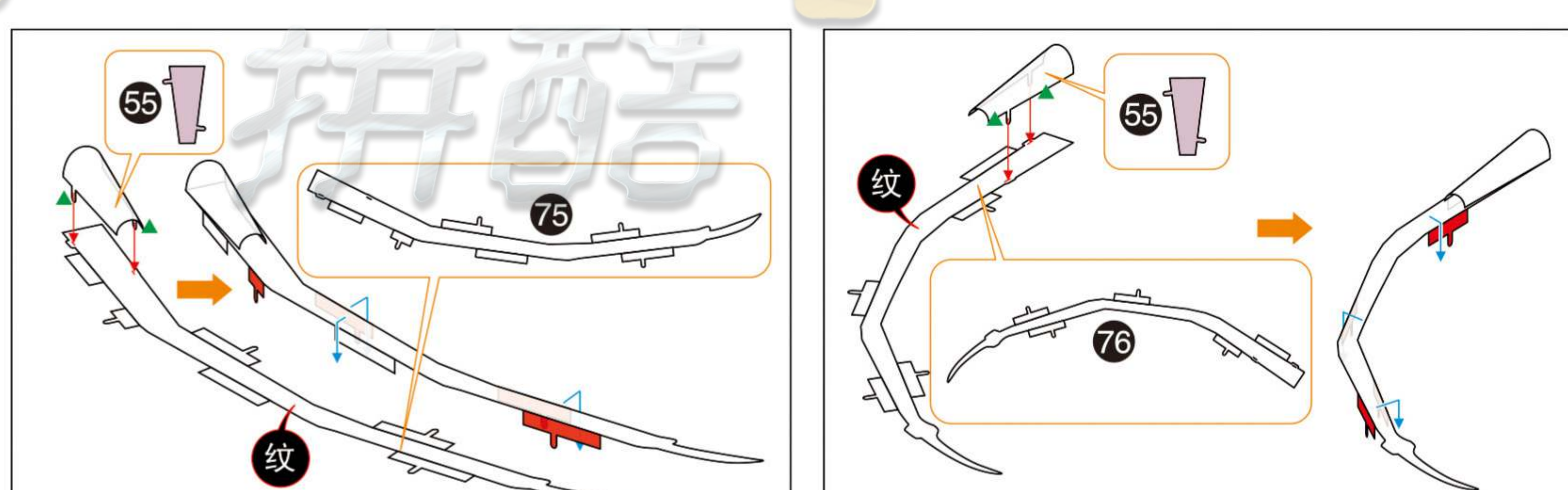
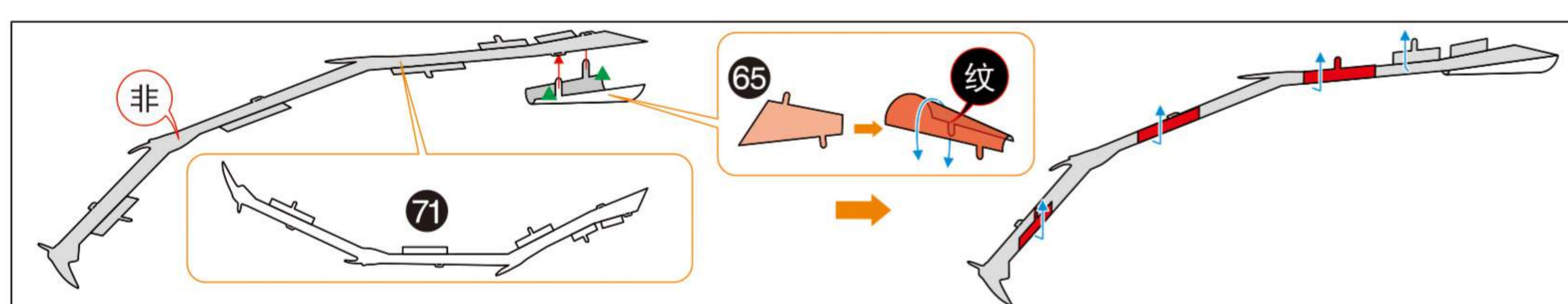
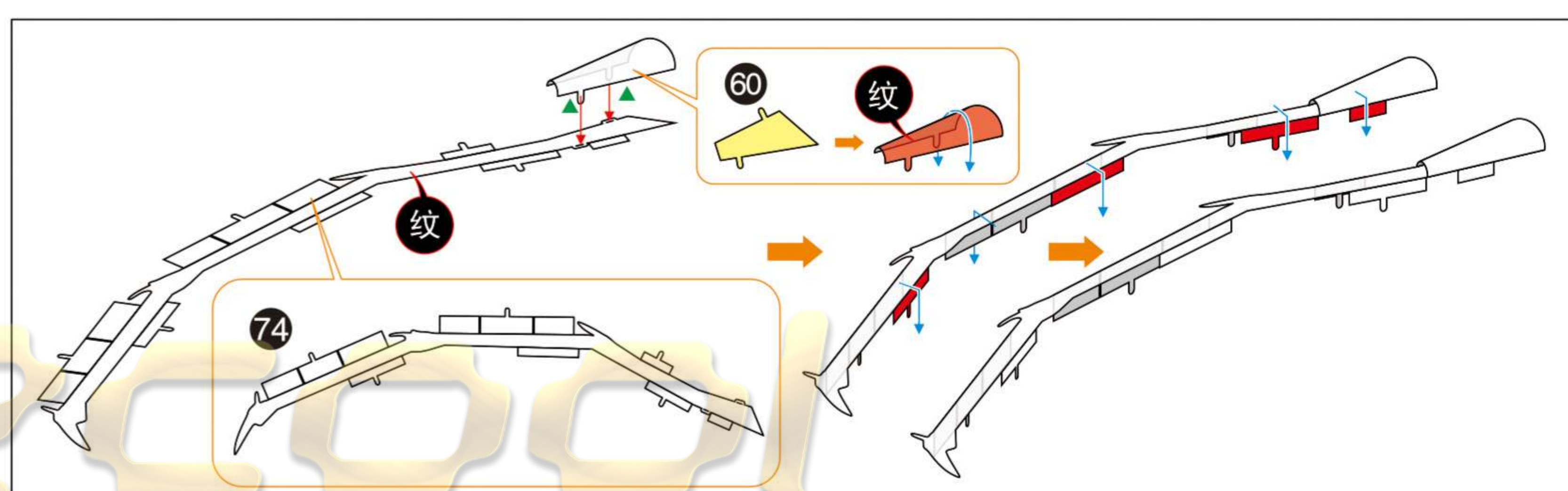
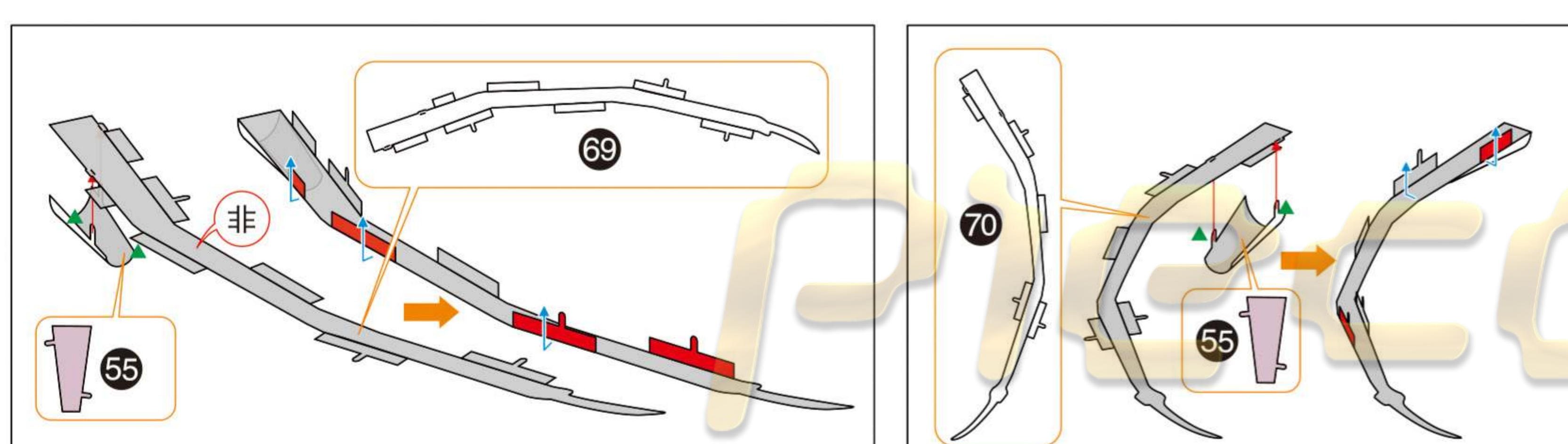
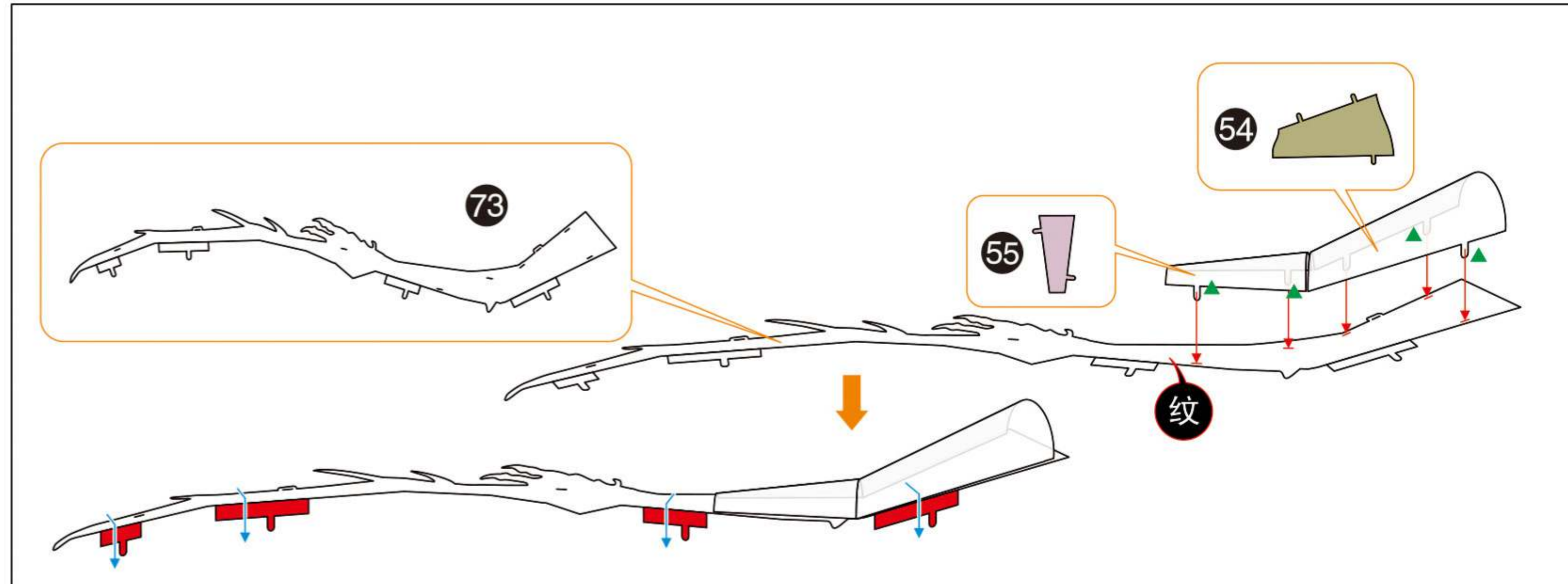
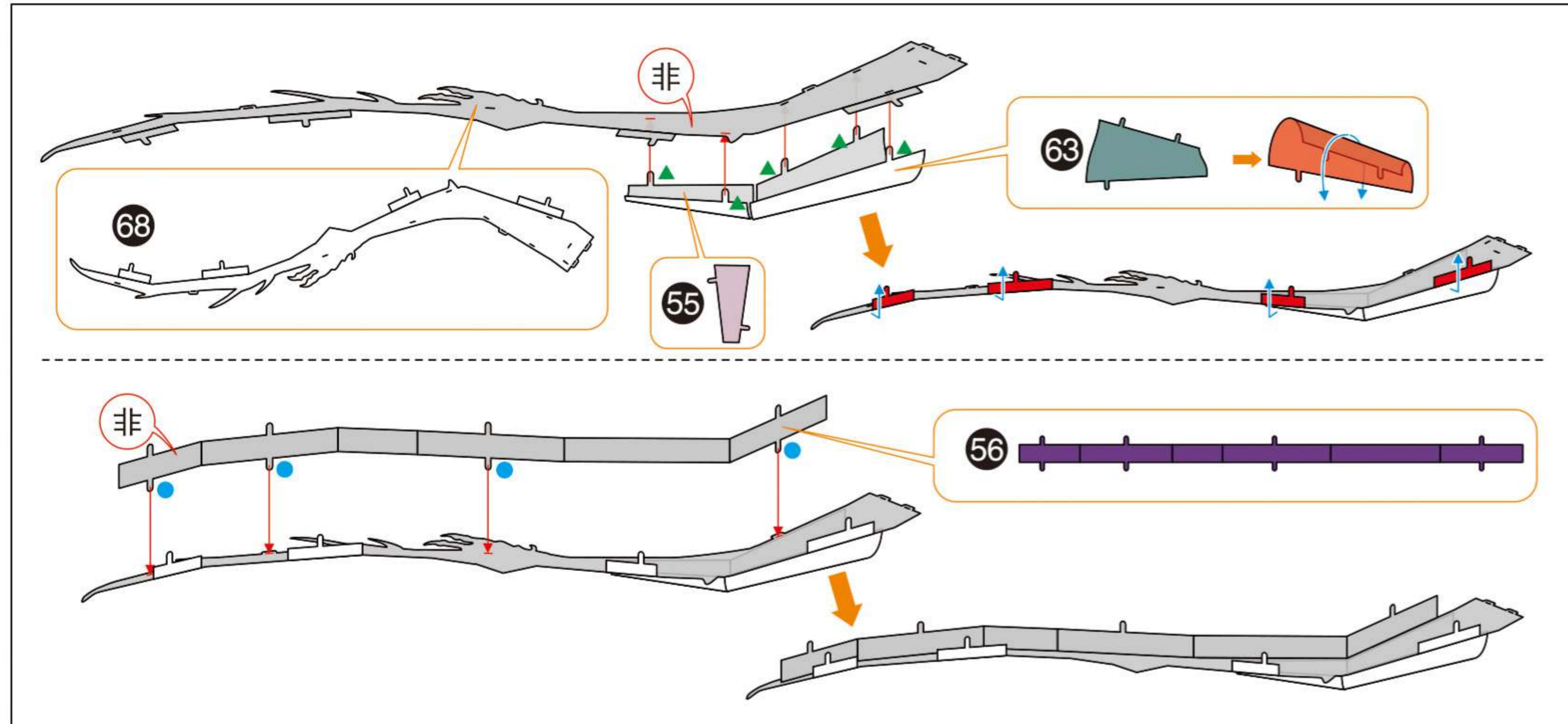

13 14
15 16

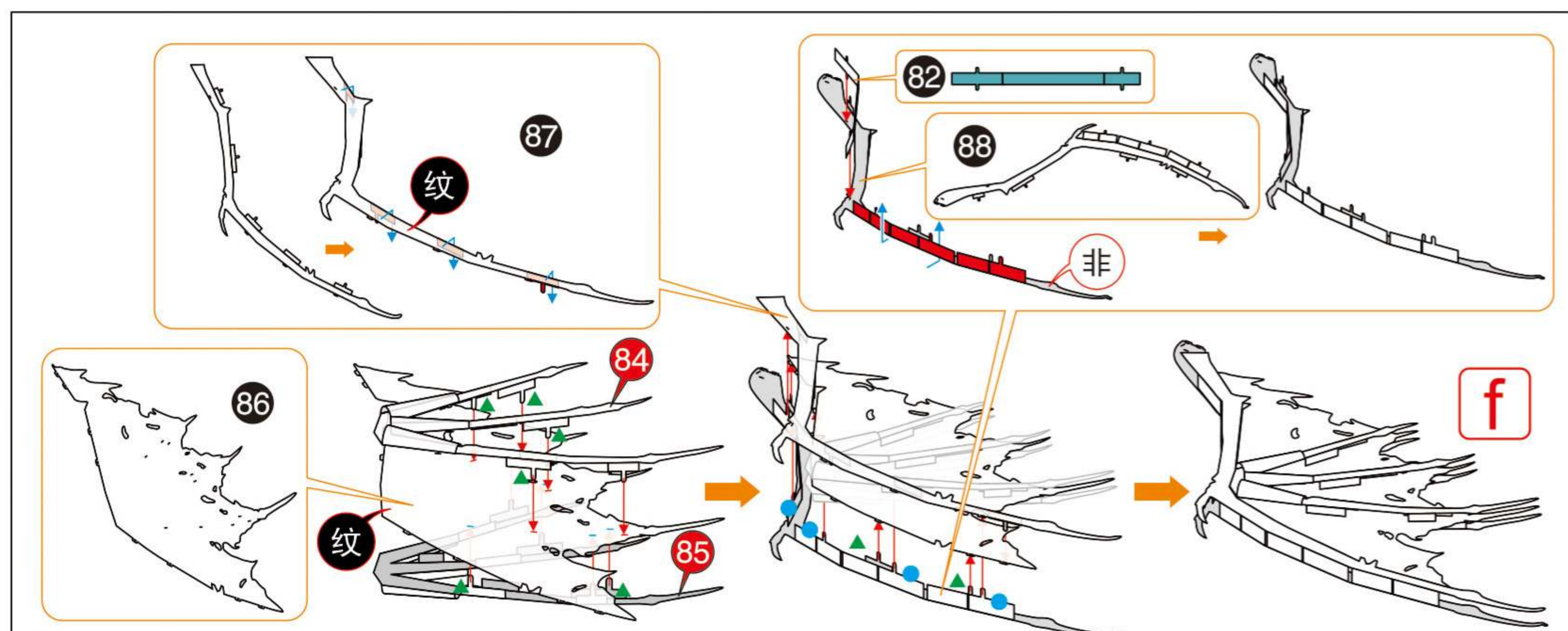
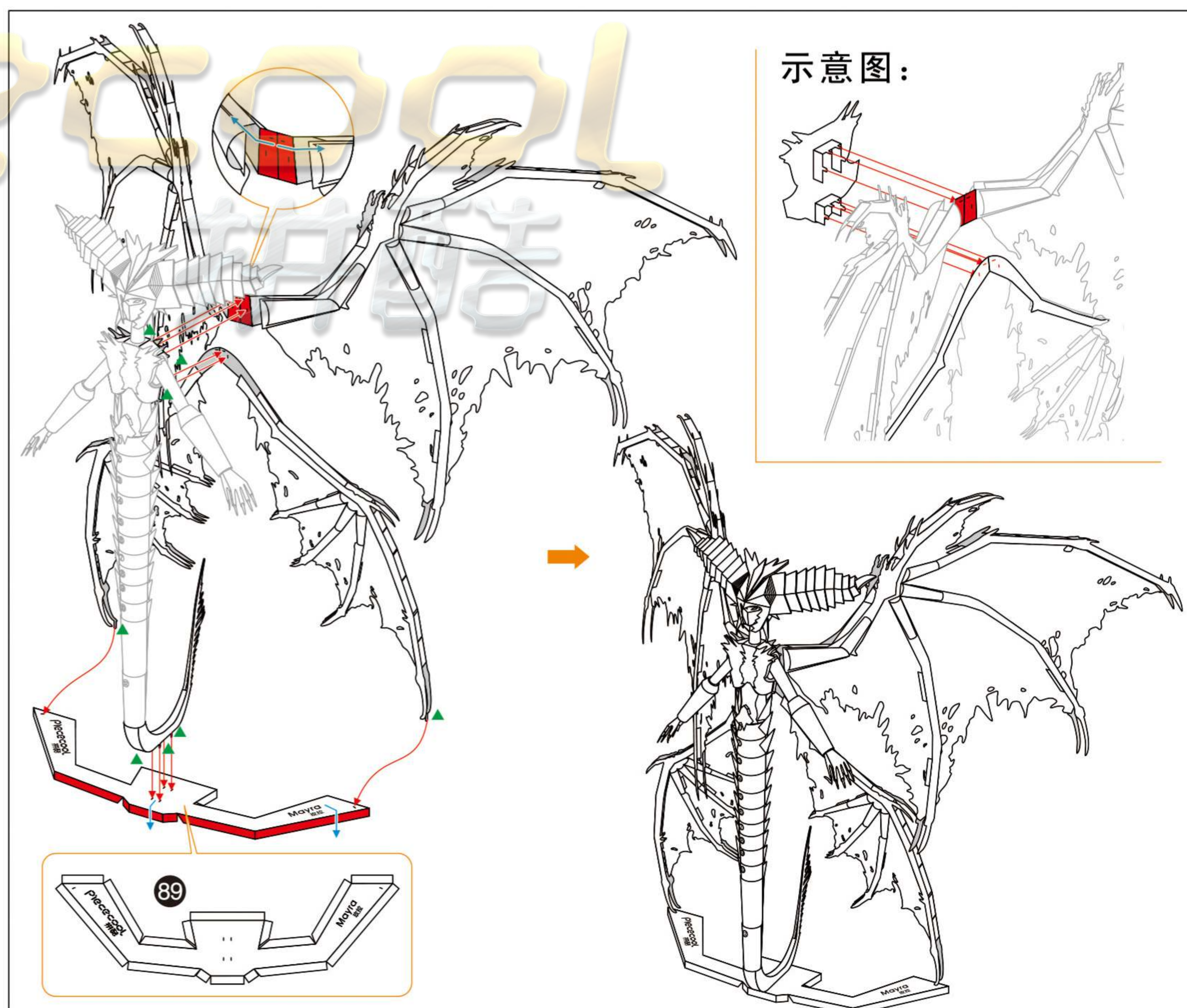
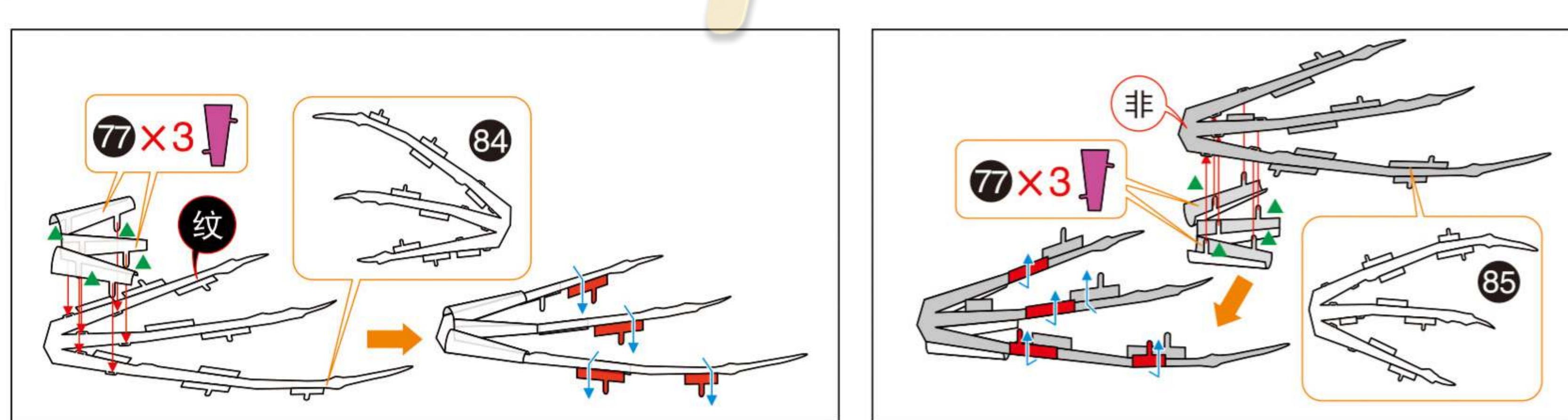
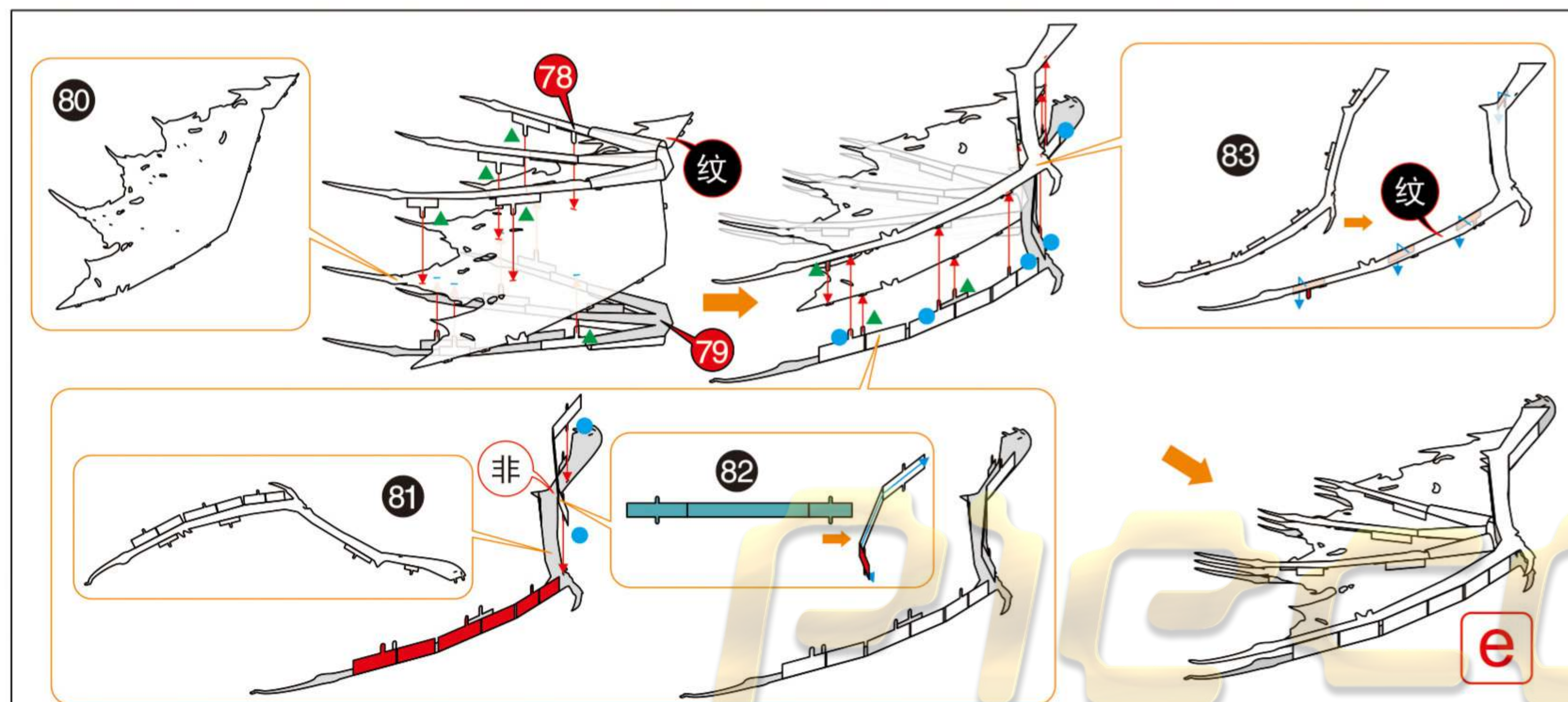
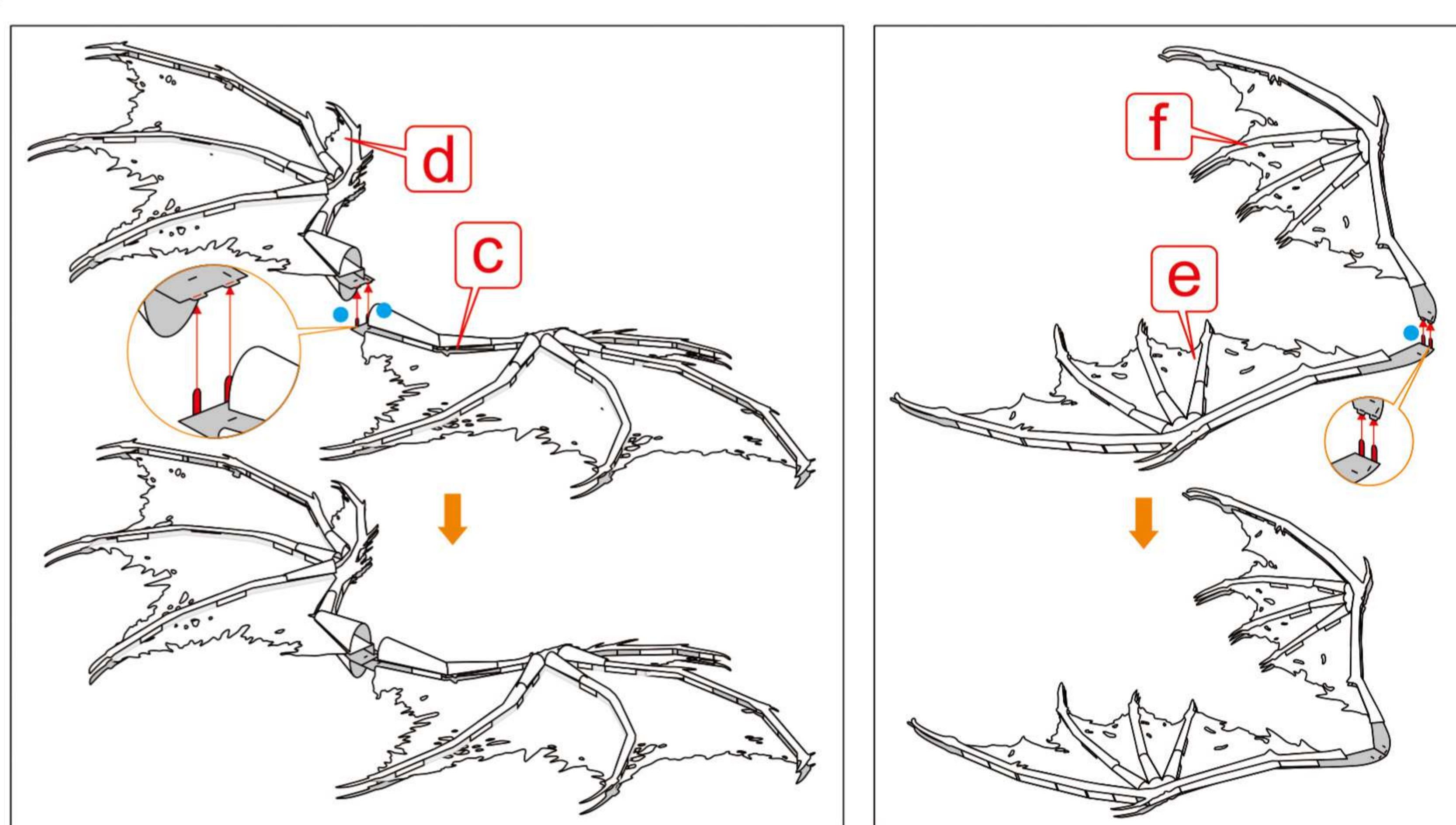
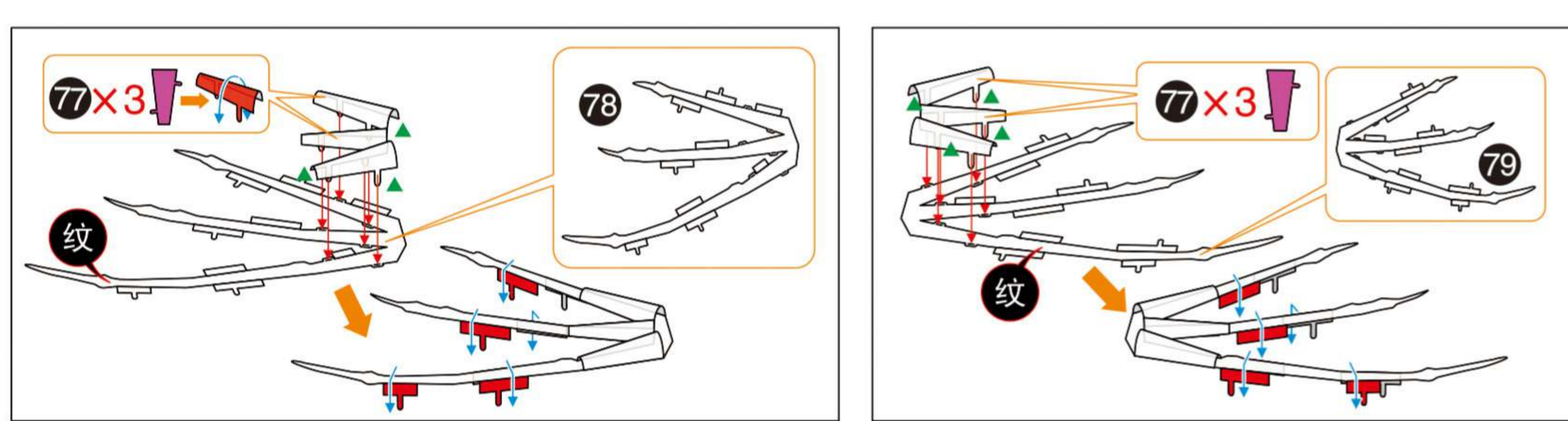

Piececool
拼酷

www.Piececool.com

© WIST PLASTIC & METAL TECHNOLOGY LIMITED. ALL RIGHTS RESERVED.