

黄鹤楼
YELLOW CRANE TOWER
P039

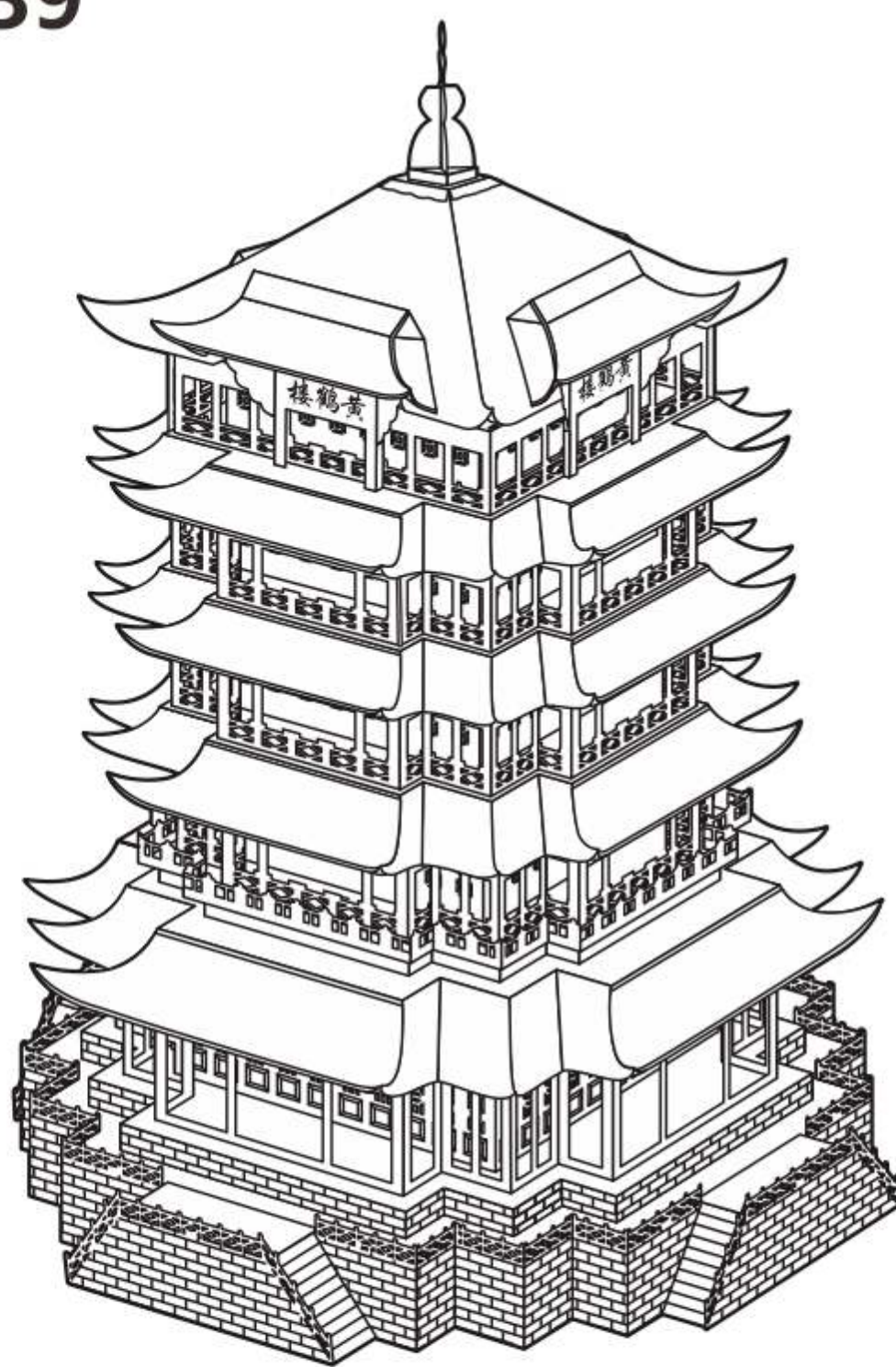

CP-ASSY-P039#-A4-20210713
电子版下载地址: <http://www.piececool.com/cpsuoming/P039.pdf>

拼装前需知

• 准备工具:

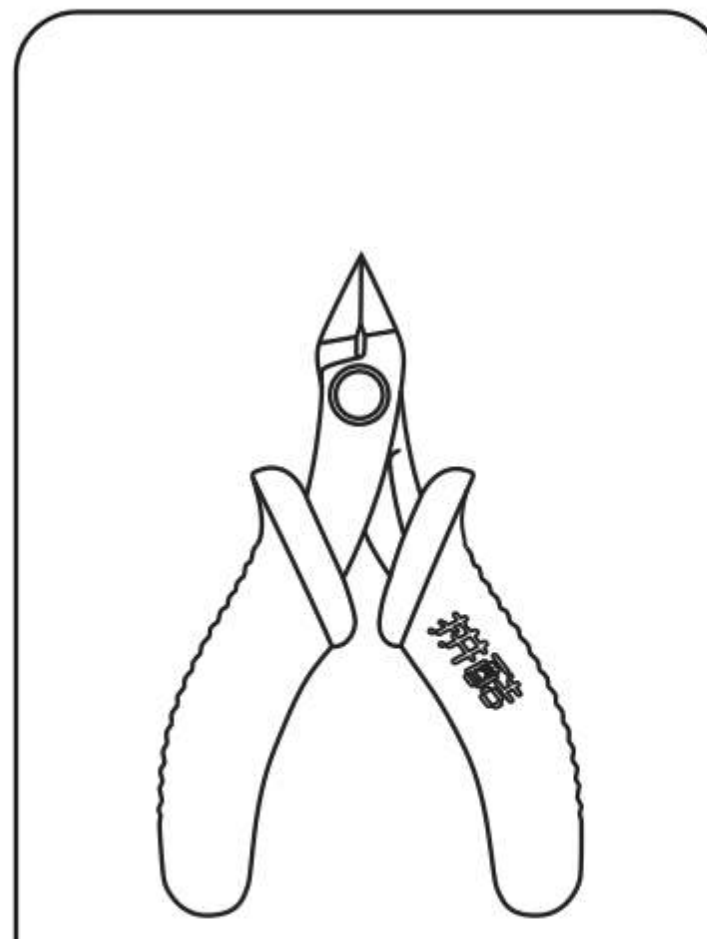

水口钳工具
修剪金属片板件上的零件水口位。

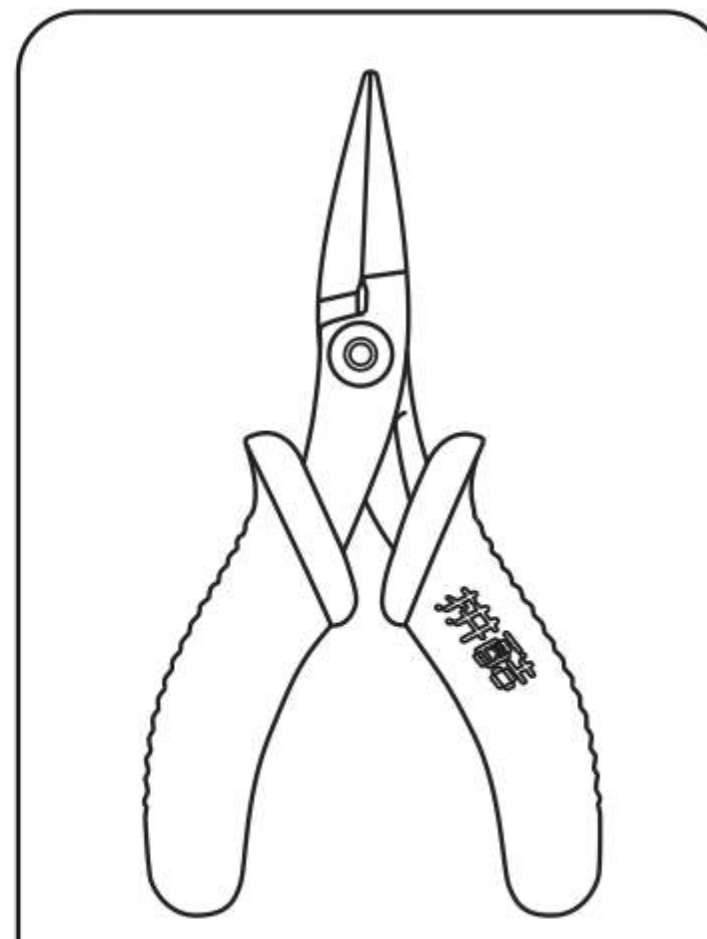

尖嘴钳工具
弯折金属零件上的折叠线和扣点。

建议使用拼酷正品拼装工具(水口钳、尖嘴钳),拼装时更省心、省力,拼装后作品更精细、美观!

⚠️ 组装时请小心处理金属零件,以防划伤

• 拼装方法:

a. 取下零件:



使用水口钳剪断金属零件上的水口,将需要的金属零件从金属片板件取下

b. 识别零件:



识别金属零件上的扣点,折叠线,扣孔的样子

c. 折叠零件:

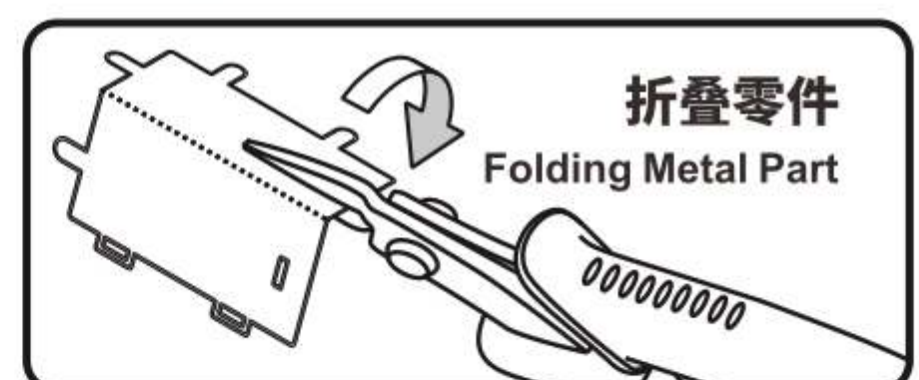

使用尖嘴钳,参照拼装说明书将金属零件折成形状

d. 固定零件:



● 插入扣孔,平折90°



▲ 插入扣孔,旋转90°

• 注意事项:



剪金属零件时请剪零件“水口位”,请勿将“扣点”当成“水口位”剪下,每次剪零件时请仅剪当前步骤的零件,切勿一次性将所有零件全部剪下,避免丢失;
当遇到折叠线的零件,请注意金属片的正反面及拼折方向,请按照说明书的方向,轻剪慢折,最好一次性折叠完成,请勿反复折叠,避免零件损坏。

© Dongguan Weishi Culture Technology Co.,Ltd. All rights reserved.

拼装步骤

Step01

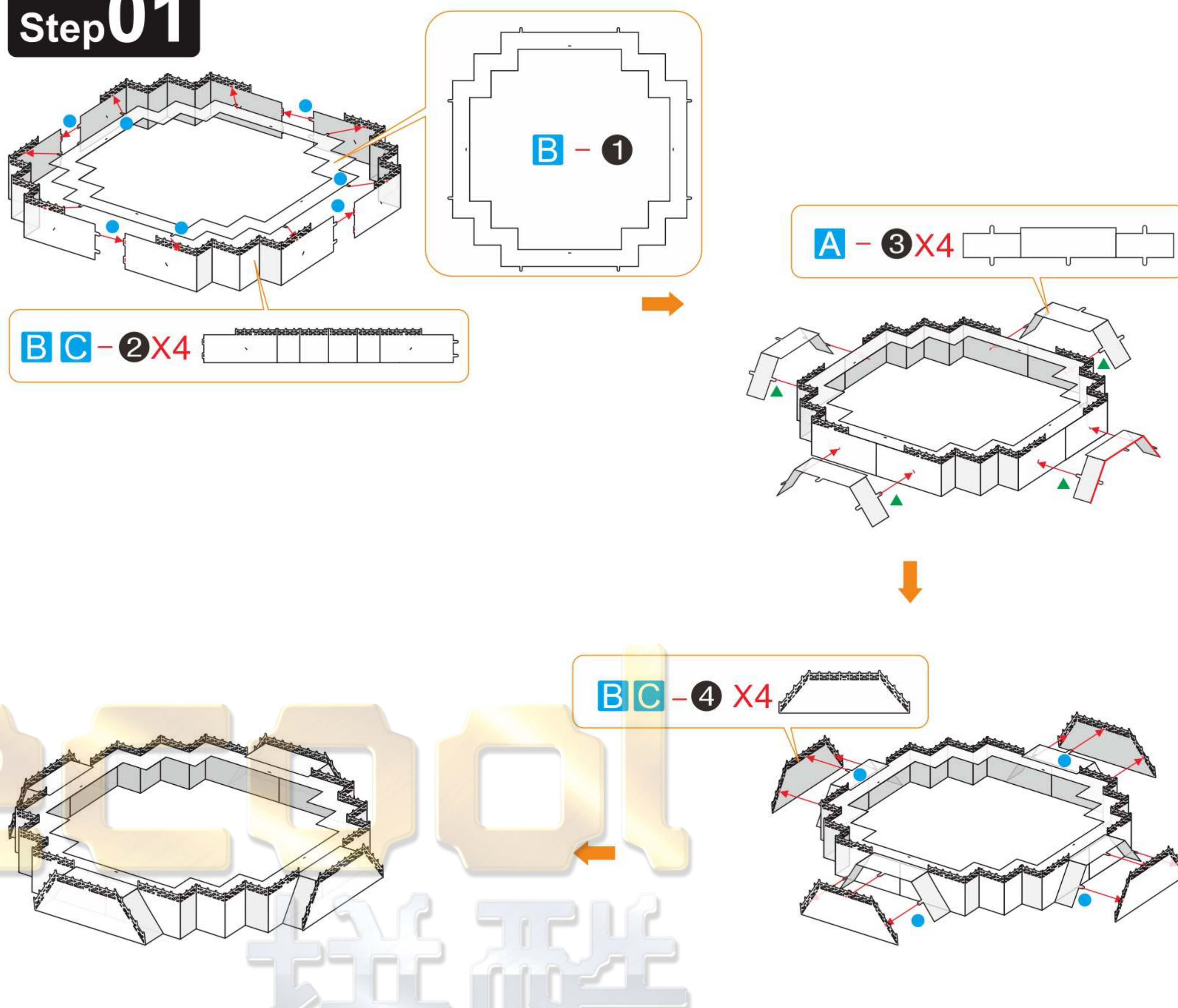

Step02

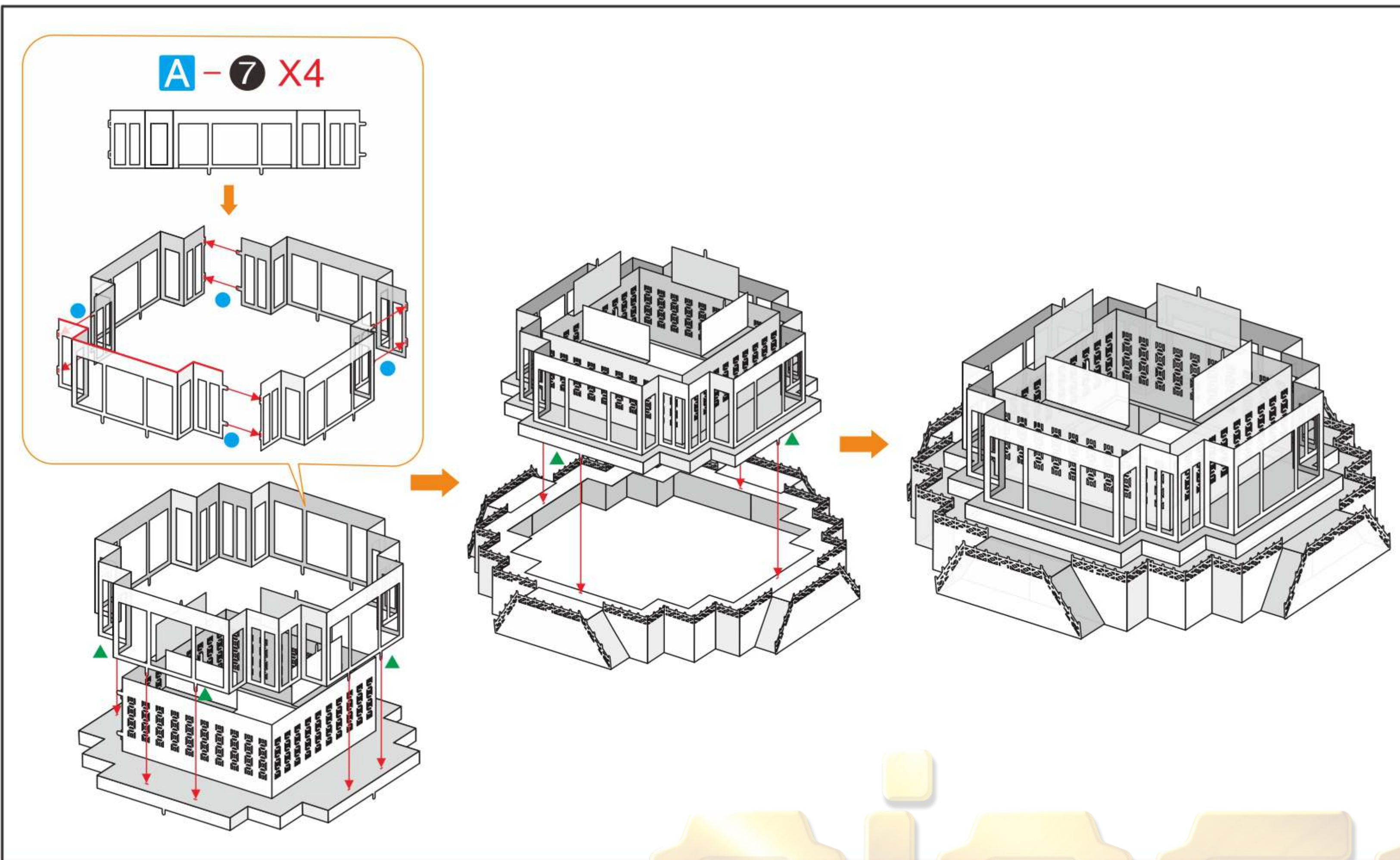
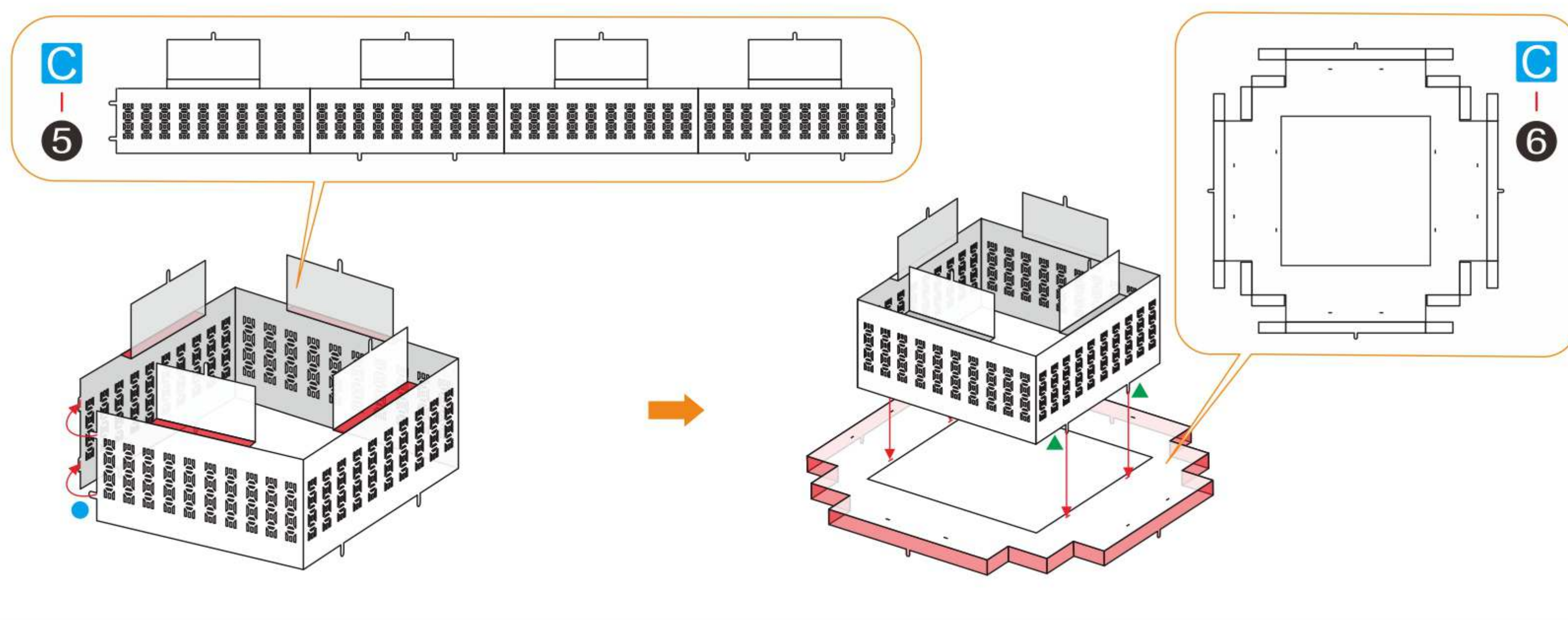

Step03

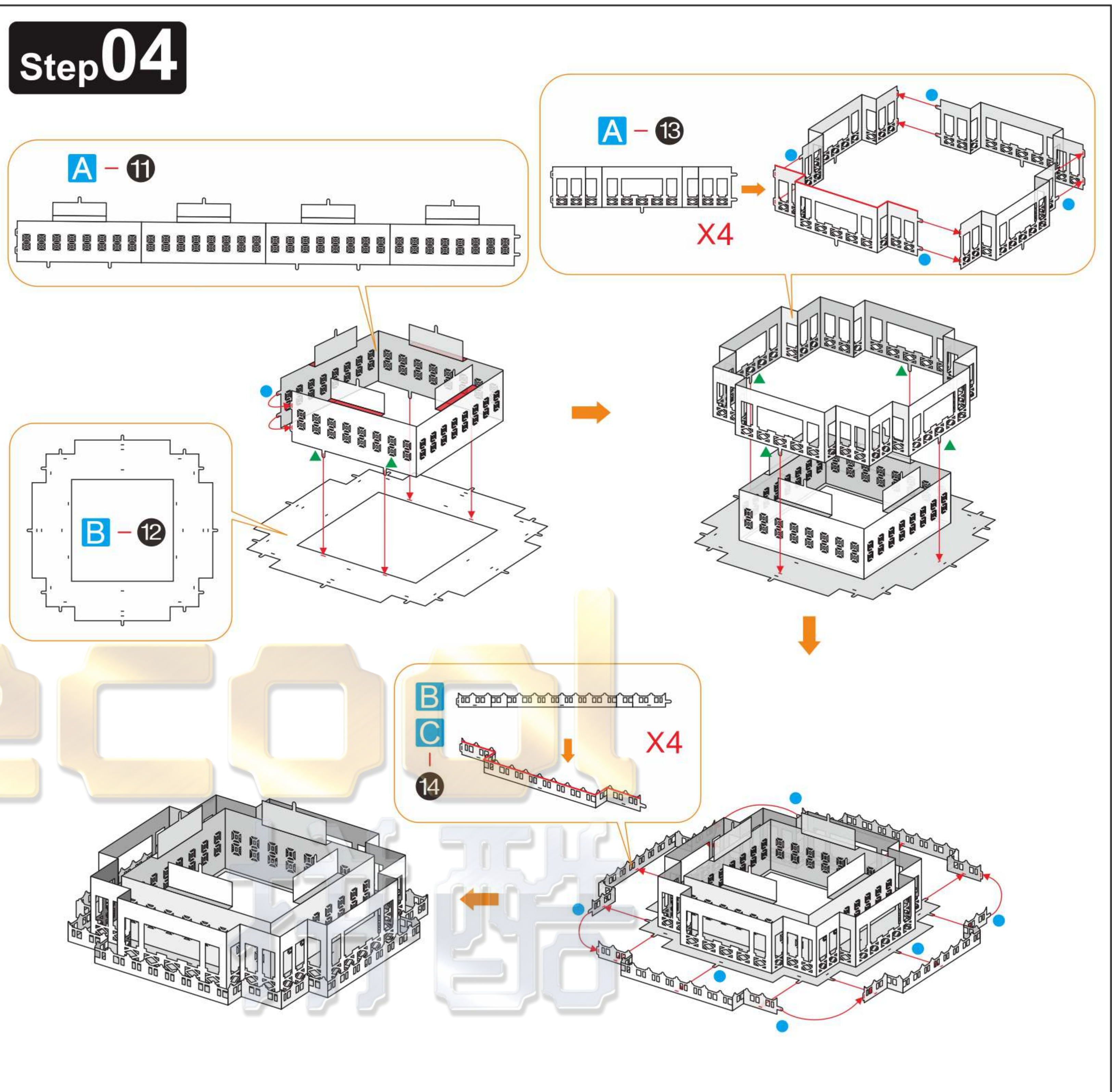
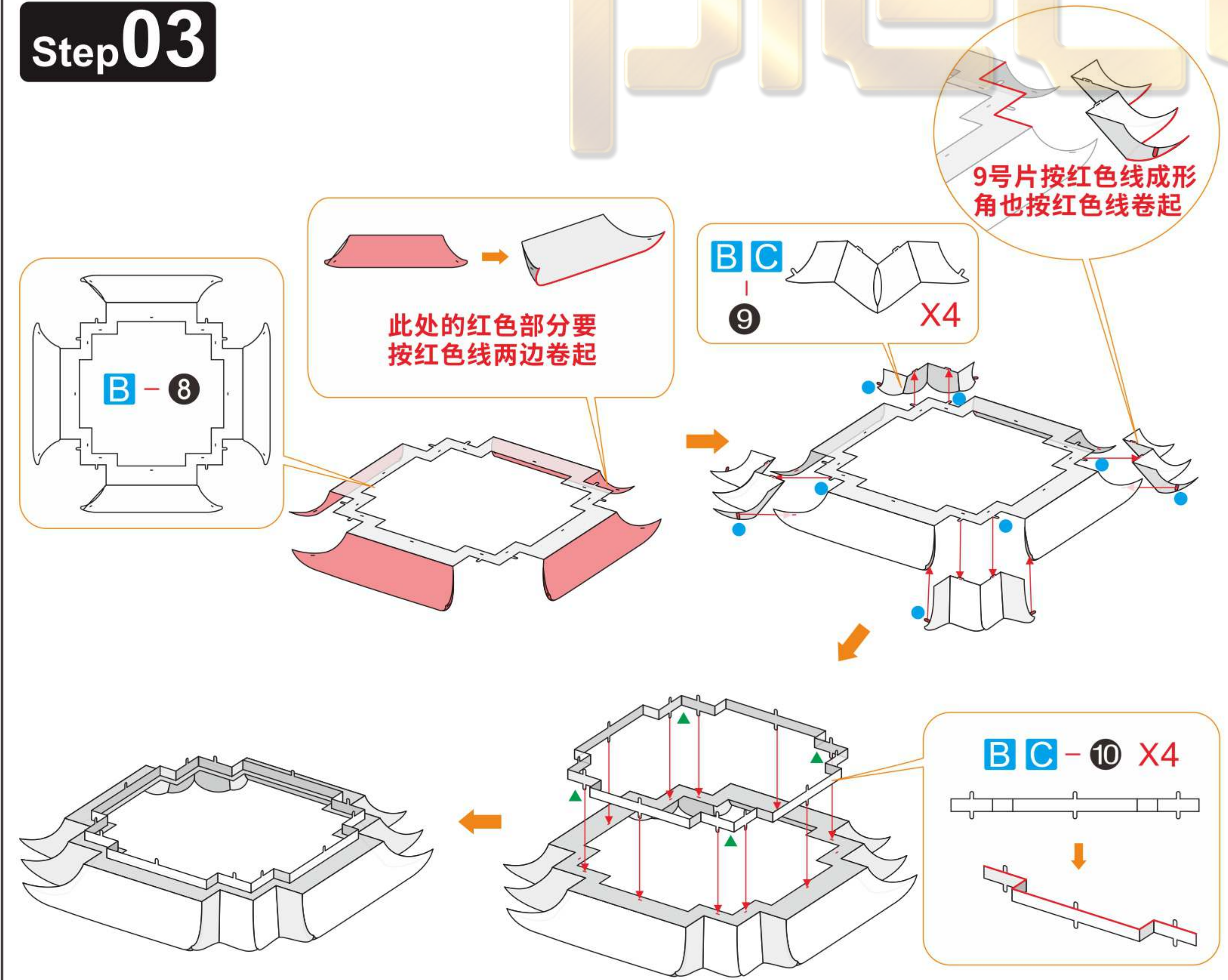

Step04

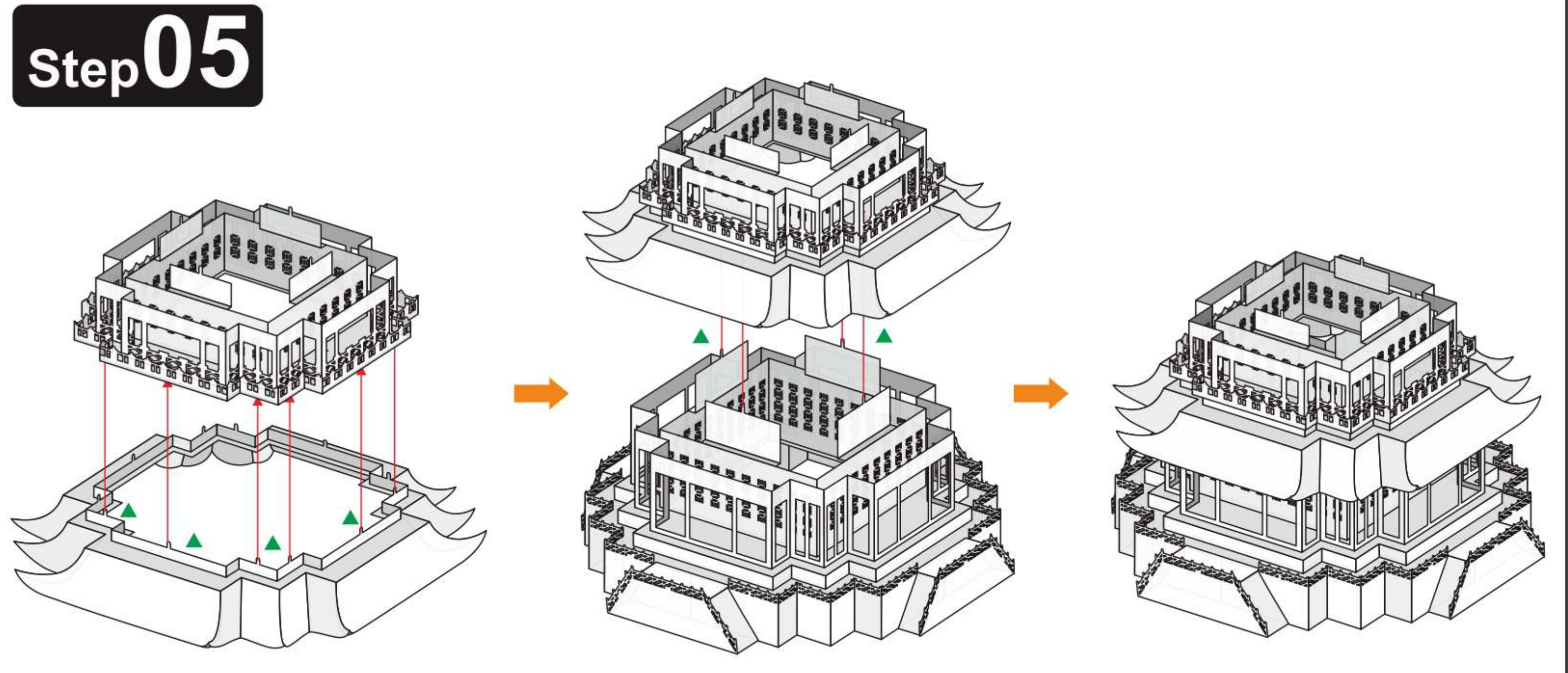

Step05

Step 06

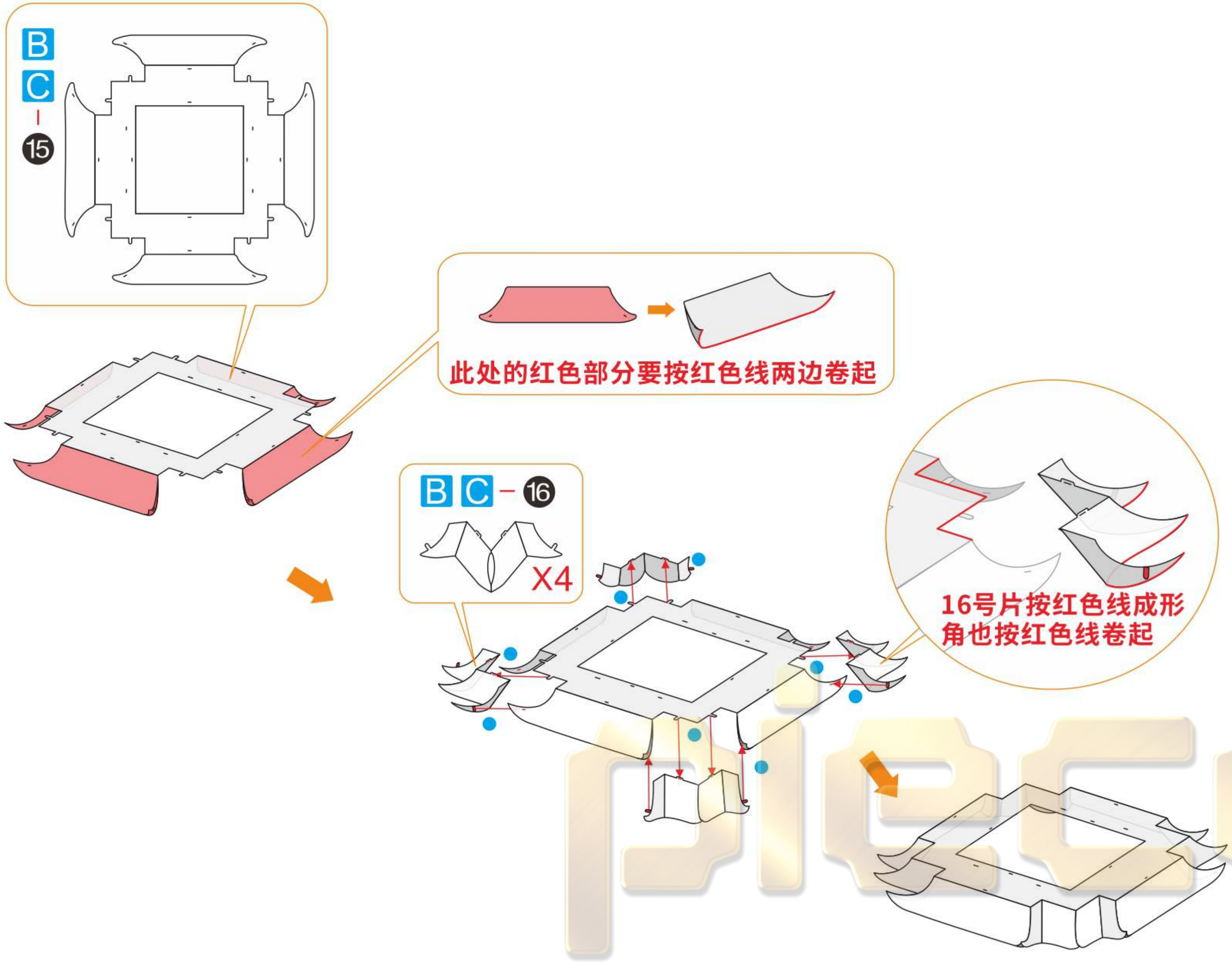

Step 07

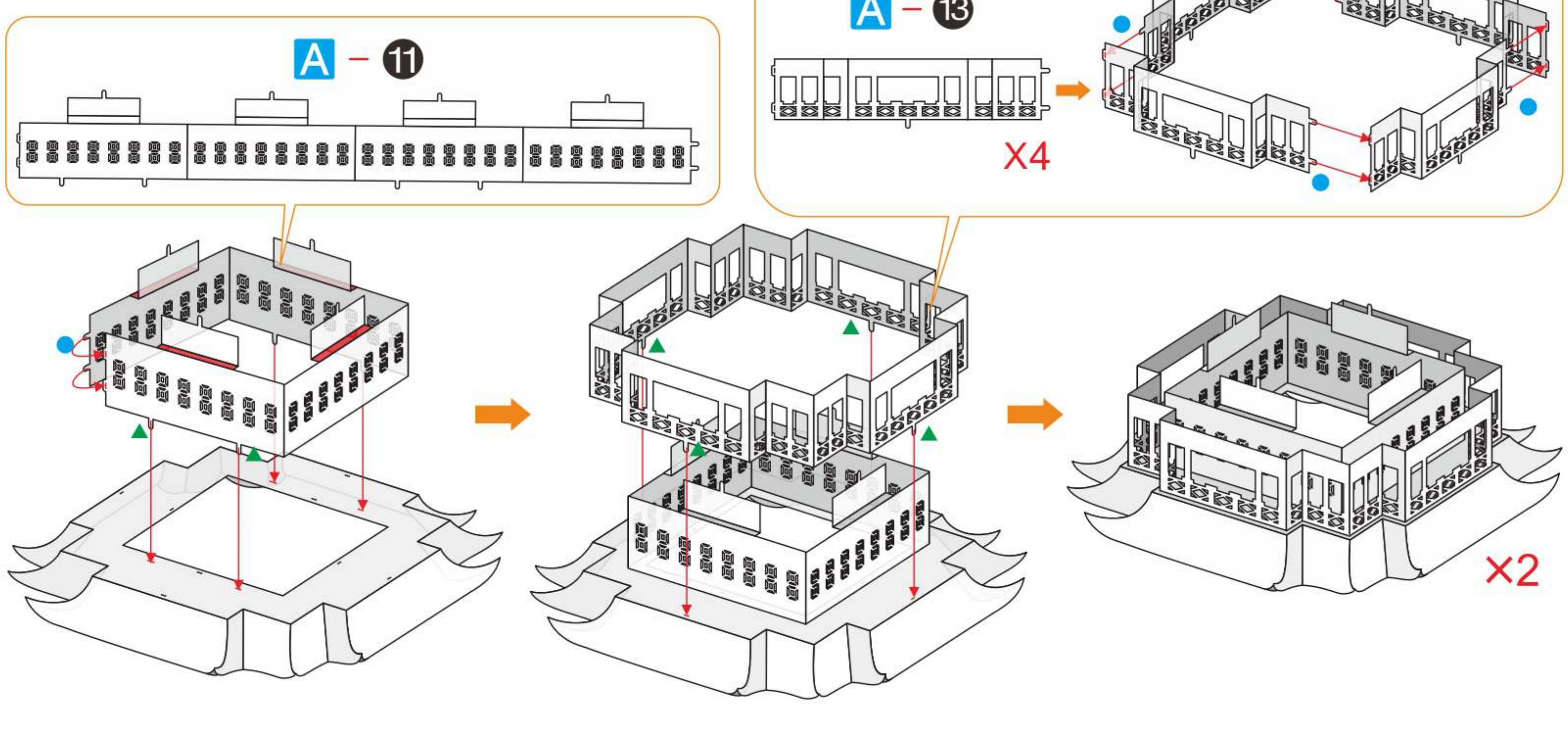

Step 10

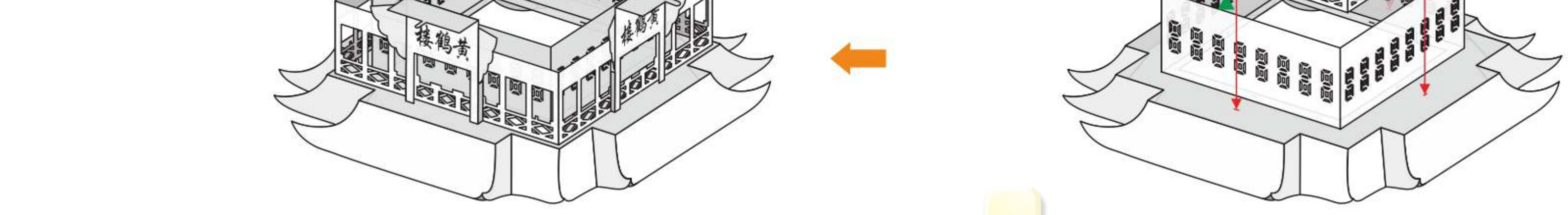

Step 11

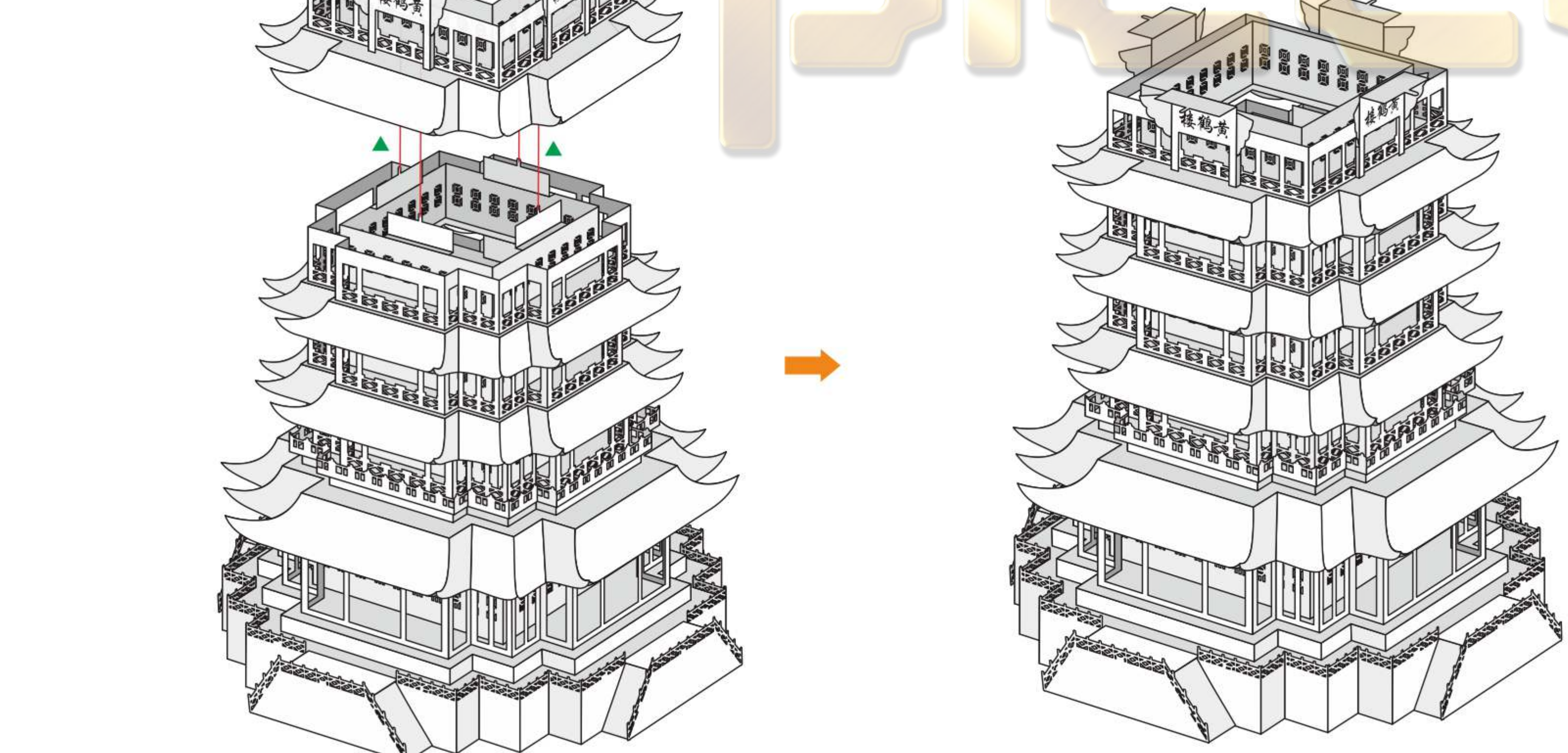

Step 12

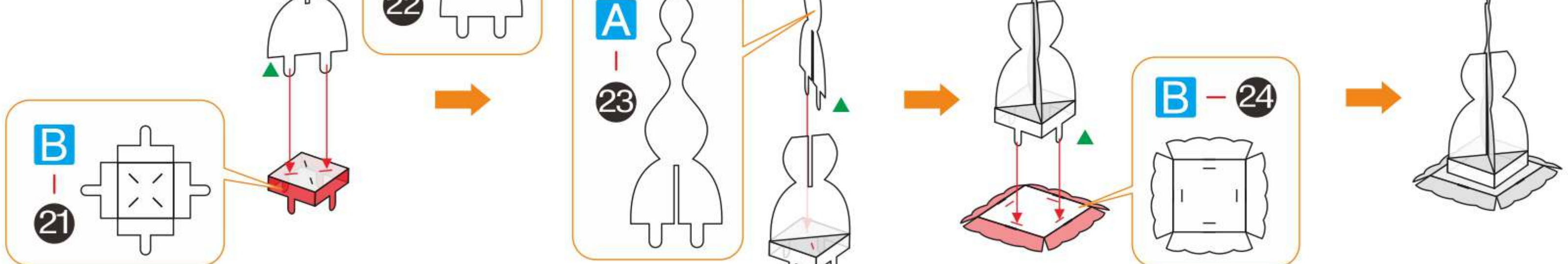

Step 08

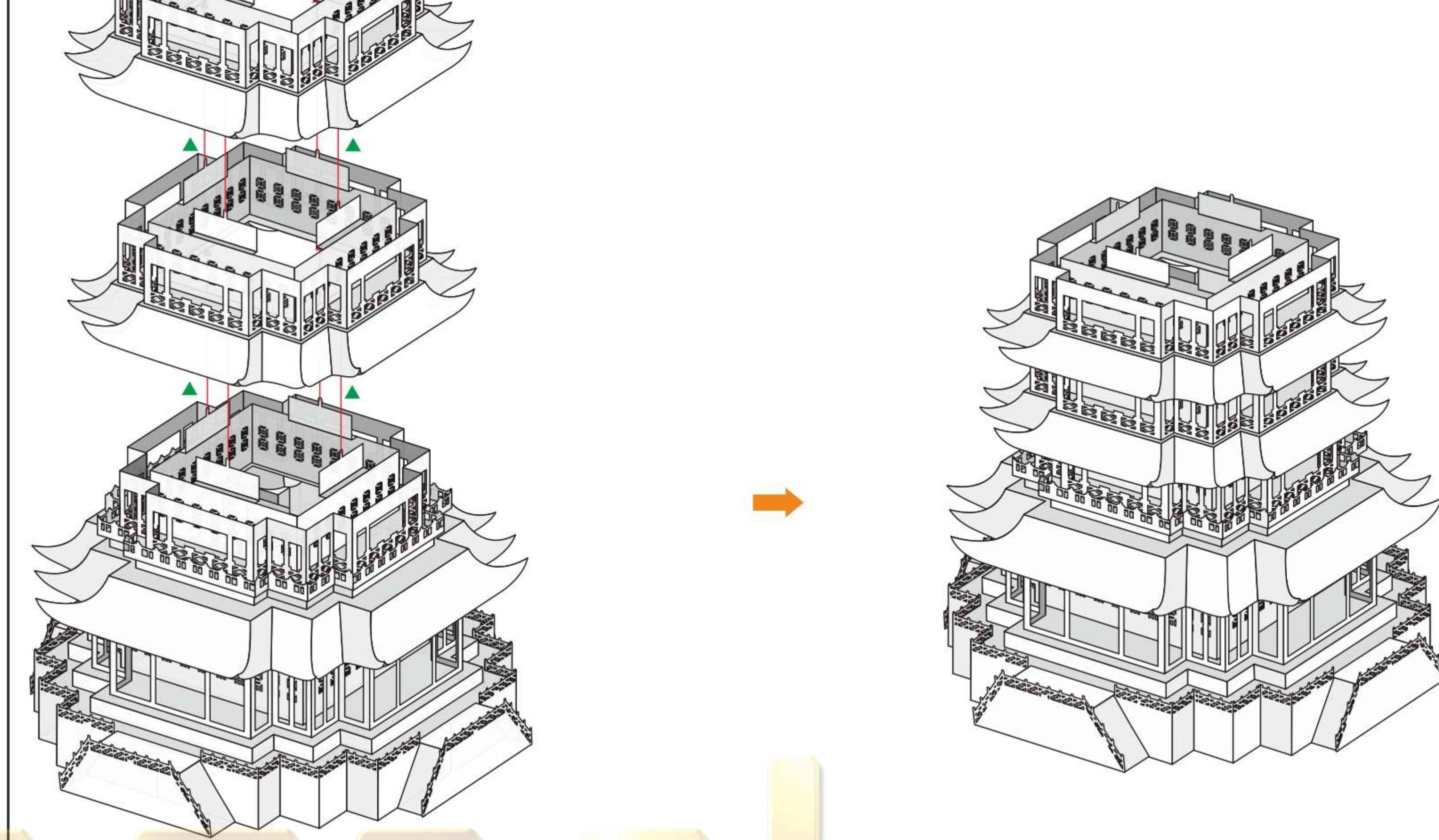

Step 09

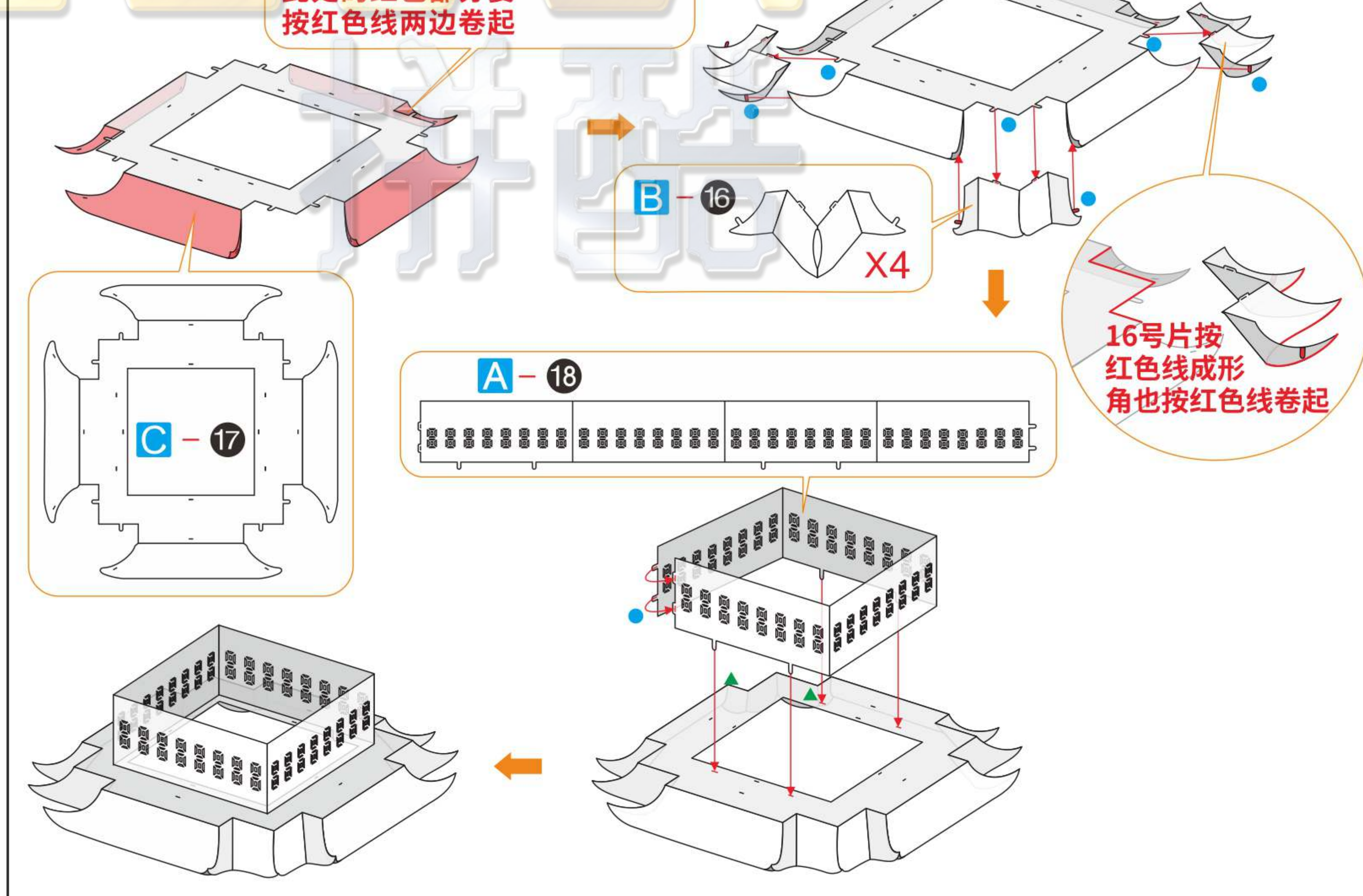

Step 13



Step 14

