



东华仙境
DONGHUA WONDERLAND
P169

拼 装 说 明 书



AGES 14+

本产品为金属制品，14岁以下需由成人陪同完成！

© WIST PLASTIC & METAL TECHNOLOGY LIMITED. ALL RIGHTS RESERVED.

电子版下载地址：<http://www.pieceecool.com/cpsuoming/P169.pdf>

拼前需知:



● 准备工具:



建议使用拼酷正品拼装工具（水口钳、尖嘴钳），拼装时更省心、省力，拼装后作品更精细、美观！

● 拼装方法:

a. 取下零件



使用水口钳剪断金属零件上的水口，将需要的金属零件从金属片板件取下。

b. 识别零件

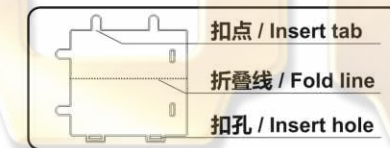

识别金属零件上的扣点、折叠线、扣孔的样子。

c. 折叠零件

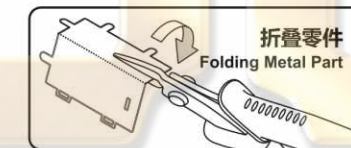

使用尖嘴钳，参照拼装说明书将金属零件折成形状。

d. 固定零件



● 插入扣孔，平折 90°

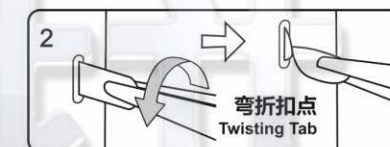

▲ 插入扣孔，旋转 90°

● 注意事项:



剪金属零件时请剪零件“水口位”，请勿将“扣点”当成“水口位”剪下，每次剪零件时请仅剪当前步骤的零件，切勿一次性将所有零件全部剪下，避免丢失；

当遇到折叠线的零件，请注意金属片的正反面及拼折方向，请按照说明书说明的方向，轻剪慢折，最好一次折叠完成，请勿反复折叠，避免零件损坏。

拼装步骤:



Step 001

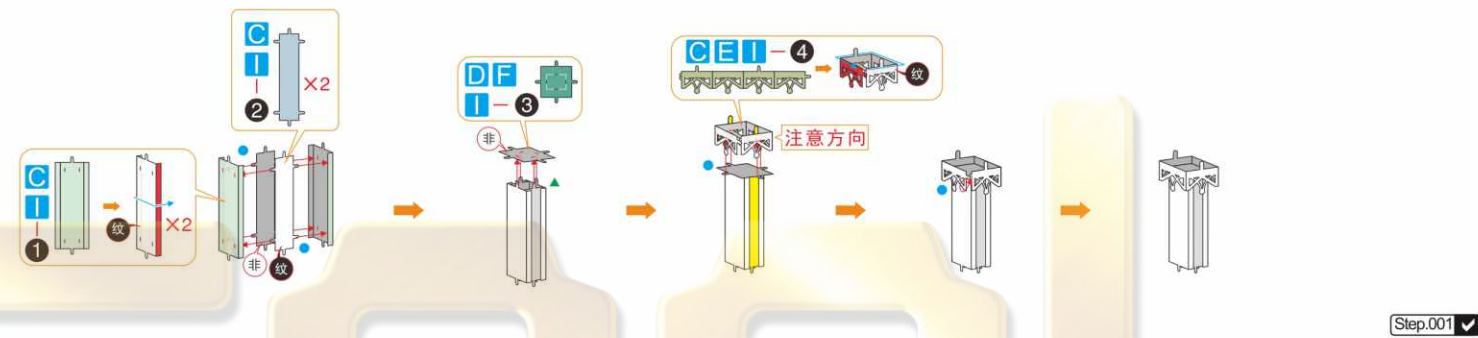

Step.001 ✓

Step 002



Step.002 ✓

Step 003

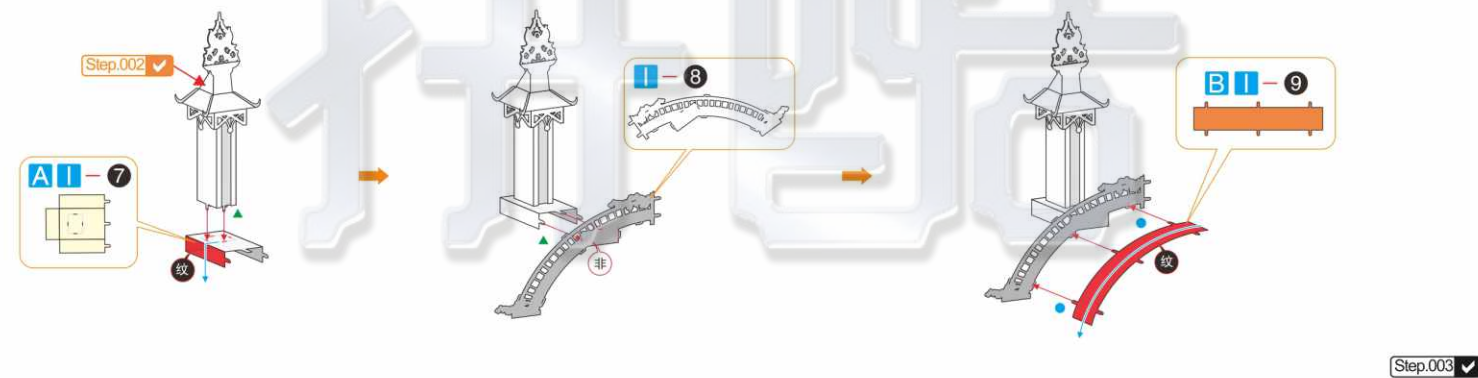

Step.003 ✓

Step 004

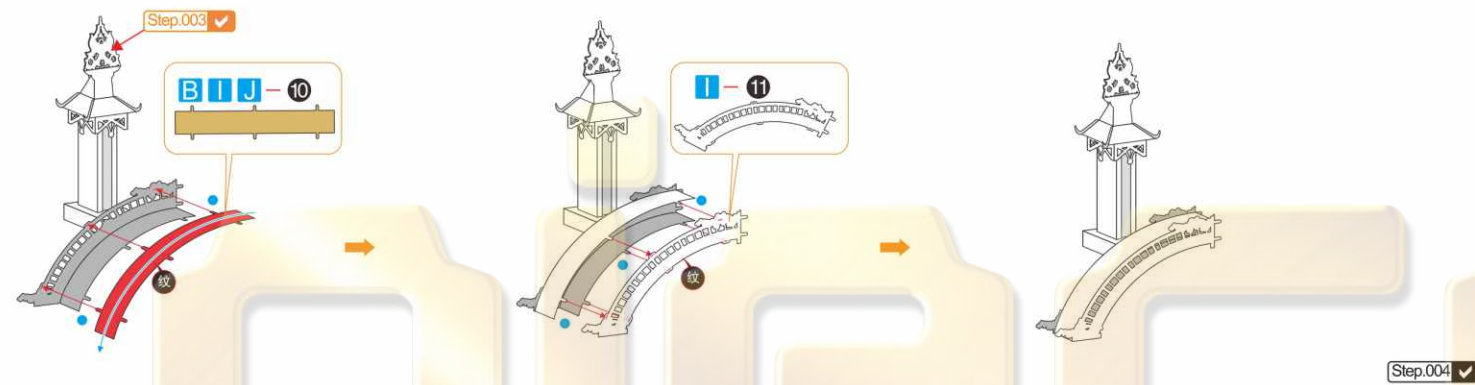

Step.004 ✓

Step 005

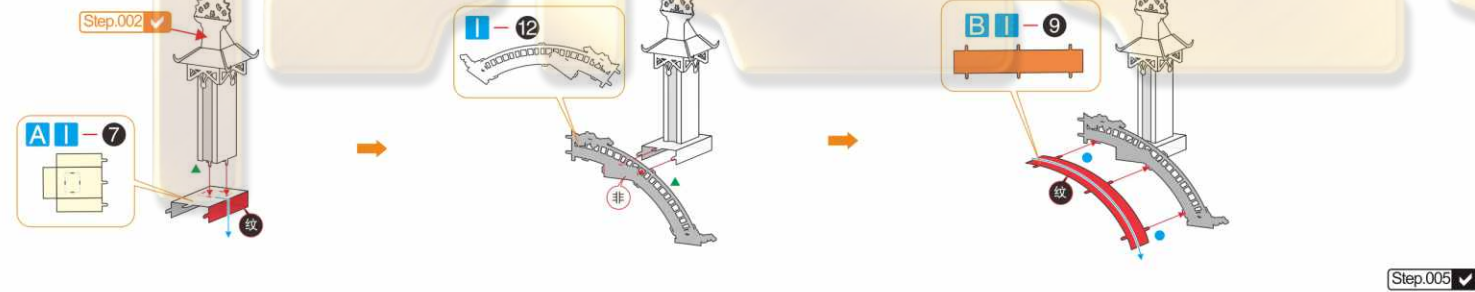

Step.005 ✓

Step 006

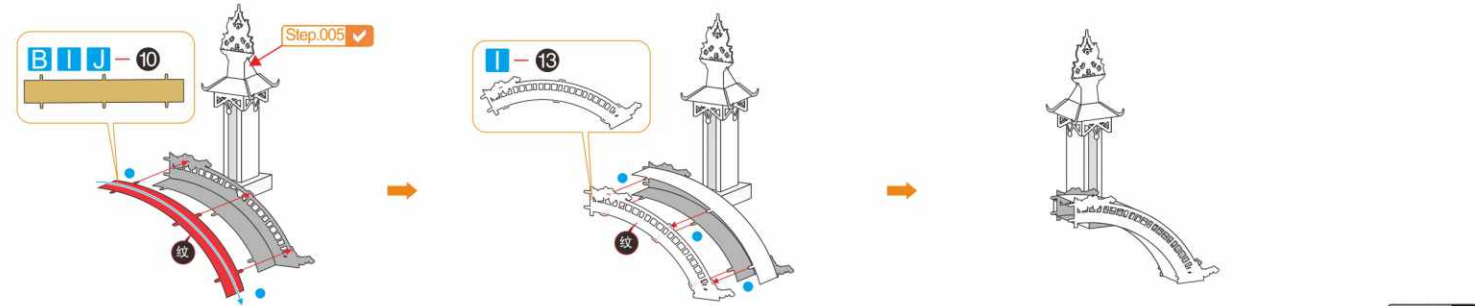

Step.006 ✓

Step 007

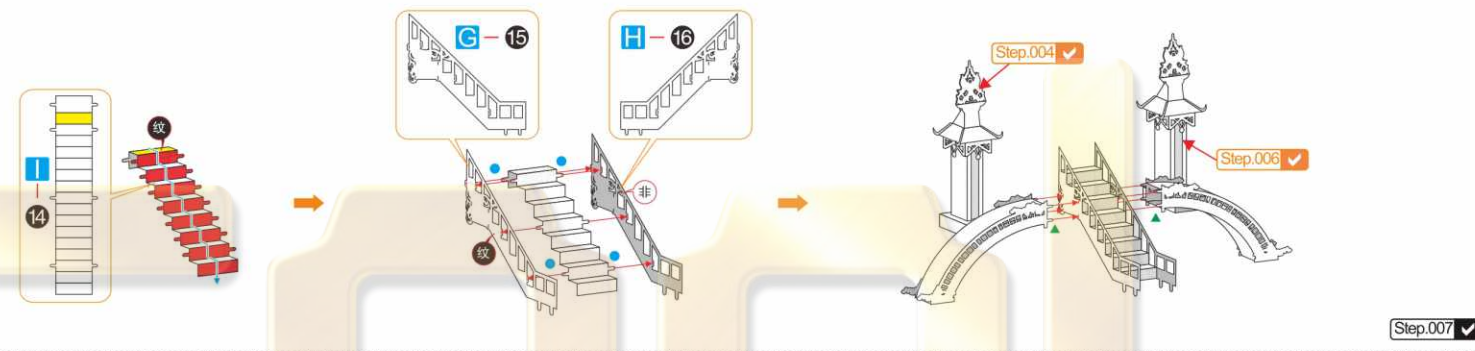

Step.007 ✓

Step 008

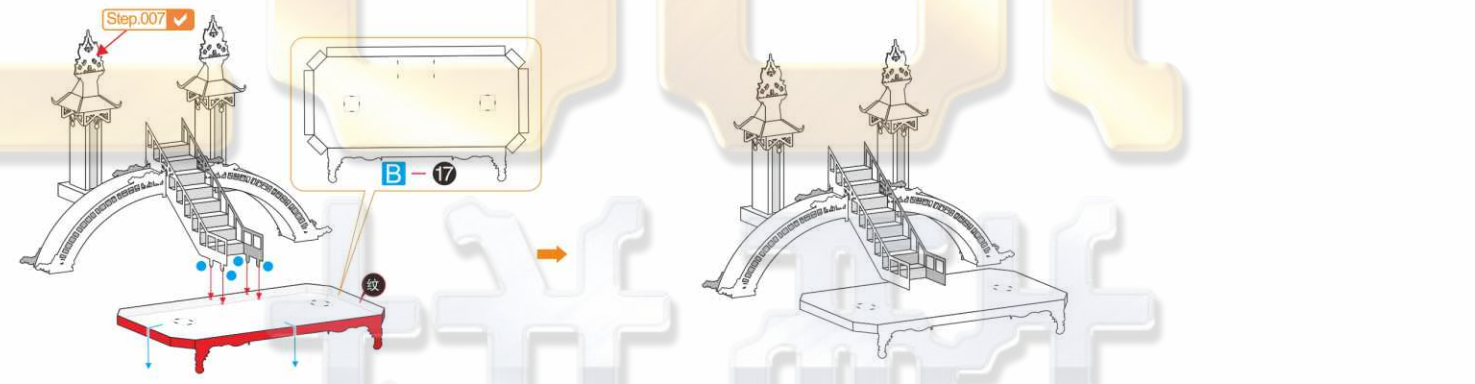

Step.008 ✓

Step 009

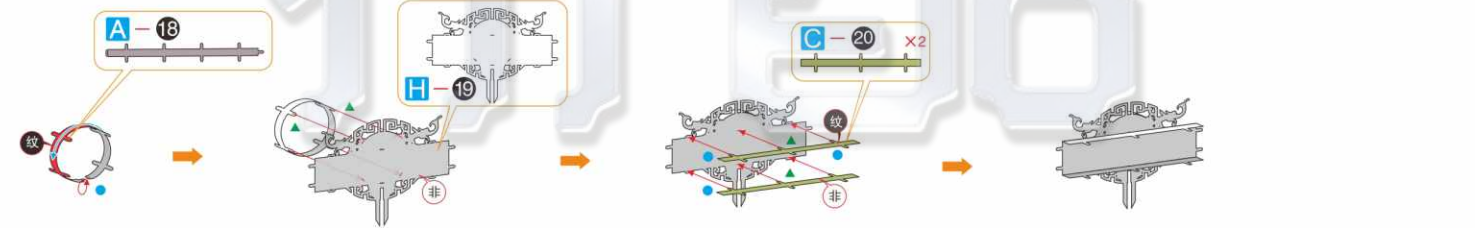

Step.009 ✓

Step 010

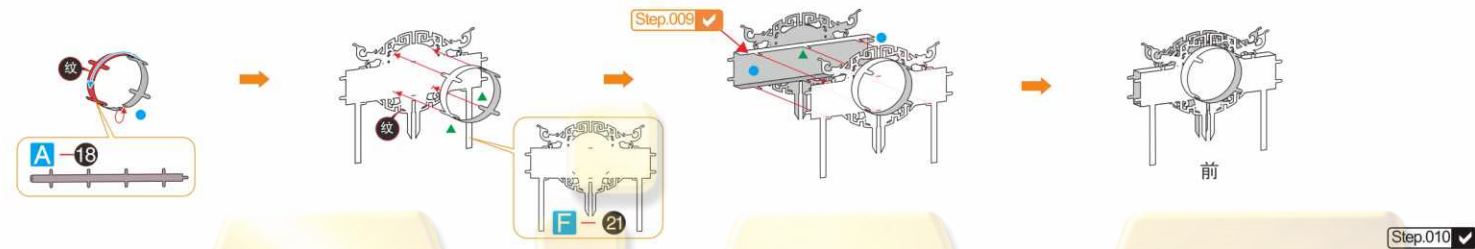

Step.010 ✓

Step 011



Step.011 ✓

Step 012

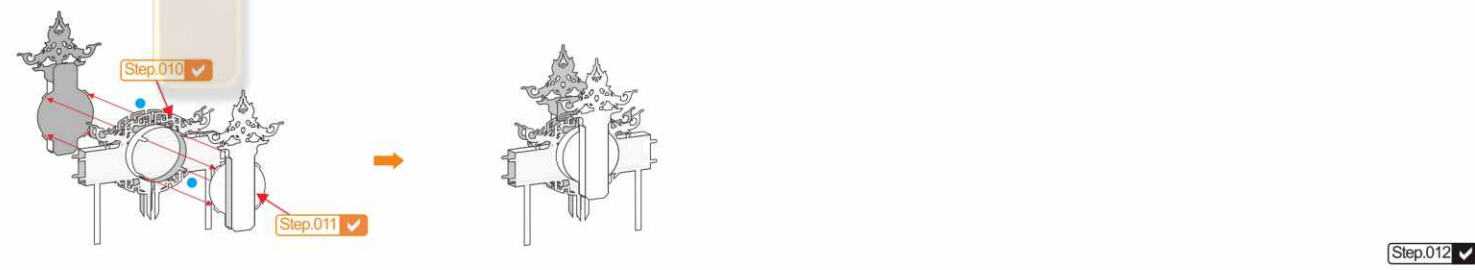

Step.012 ✓

Step 013

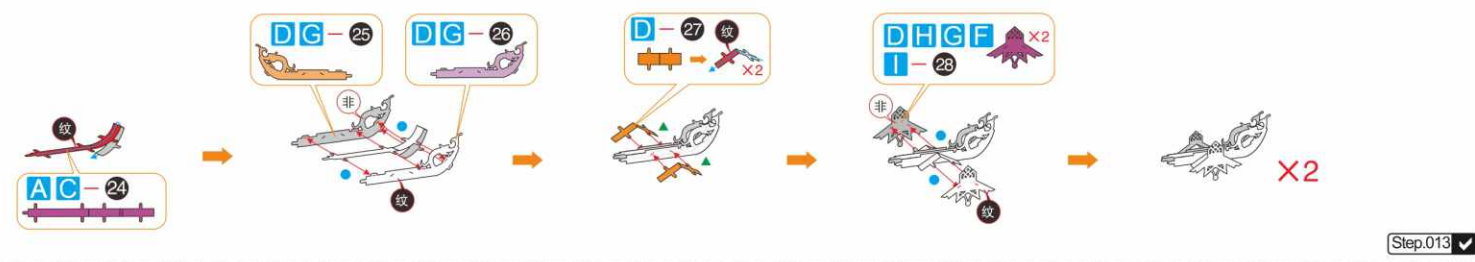

Step.013 ✓

Step 014

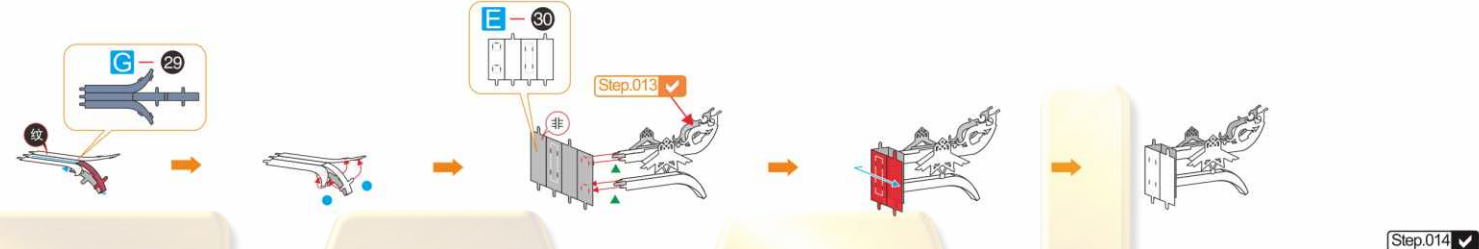

Step.014 ✓

Step 015



Step.015 ✓

Step 016

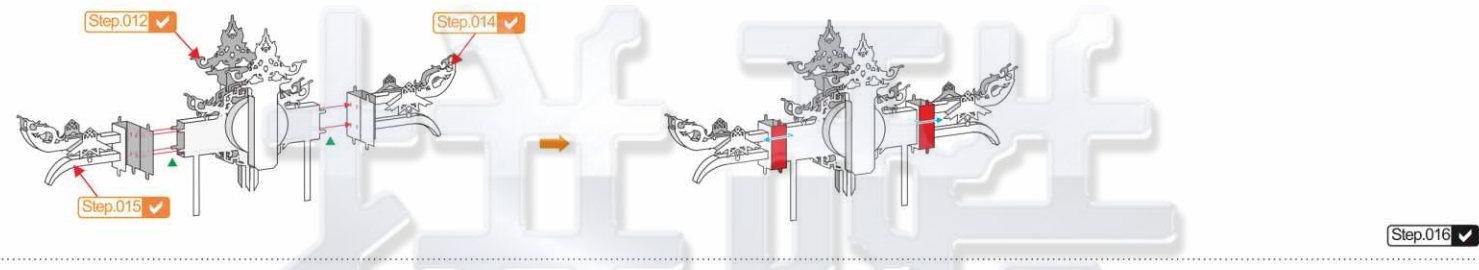

Step.016 ✓

Step 017

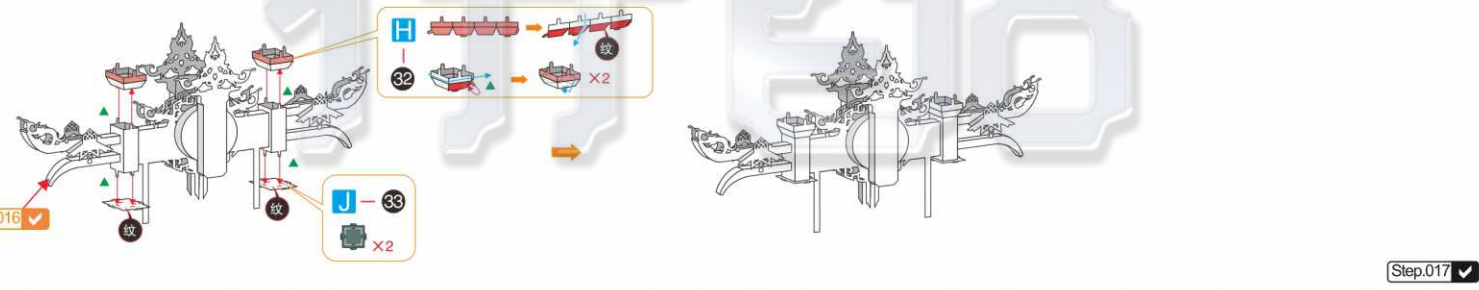

Step.017 ✓

Step 018

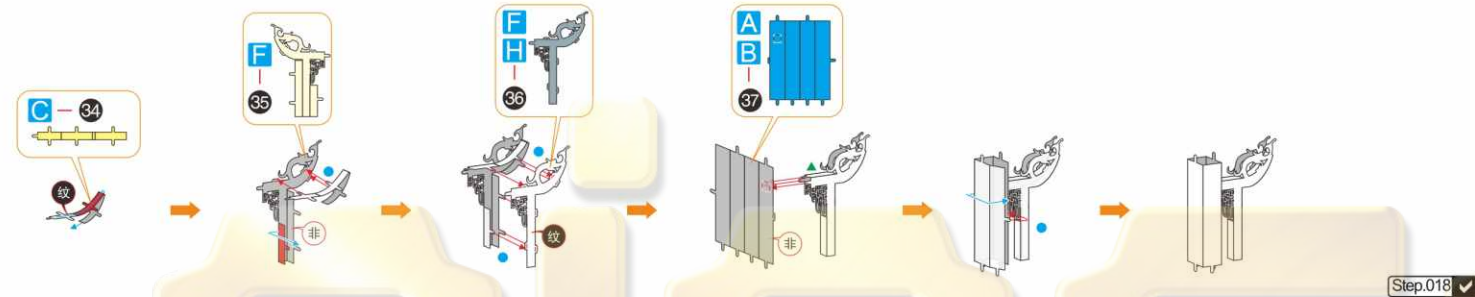

Step 019

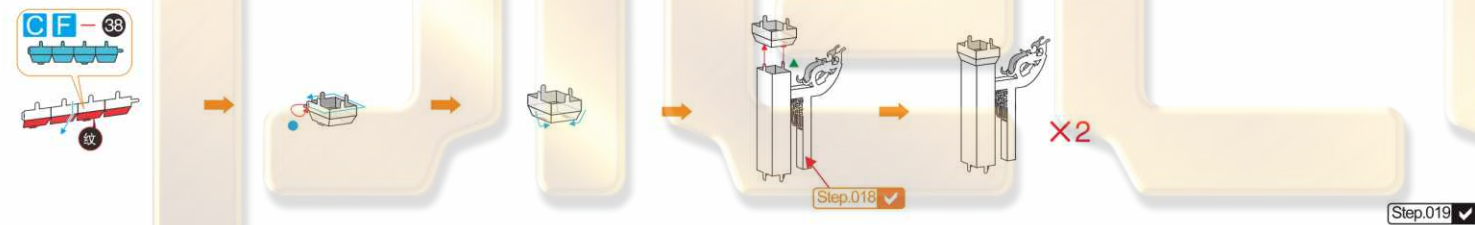

Step 020

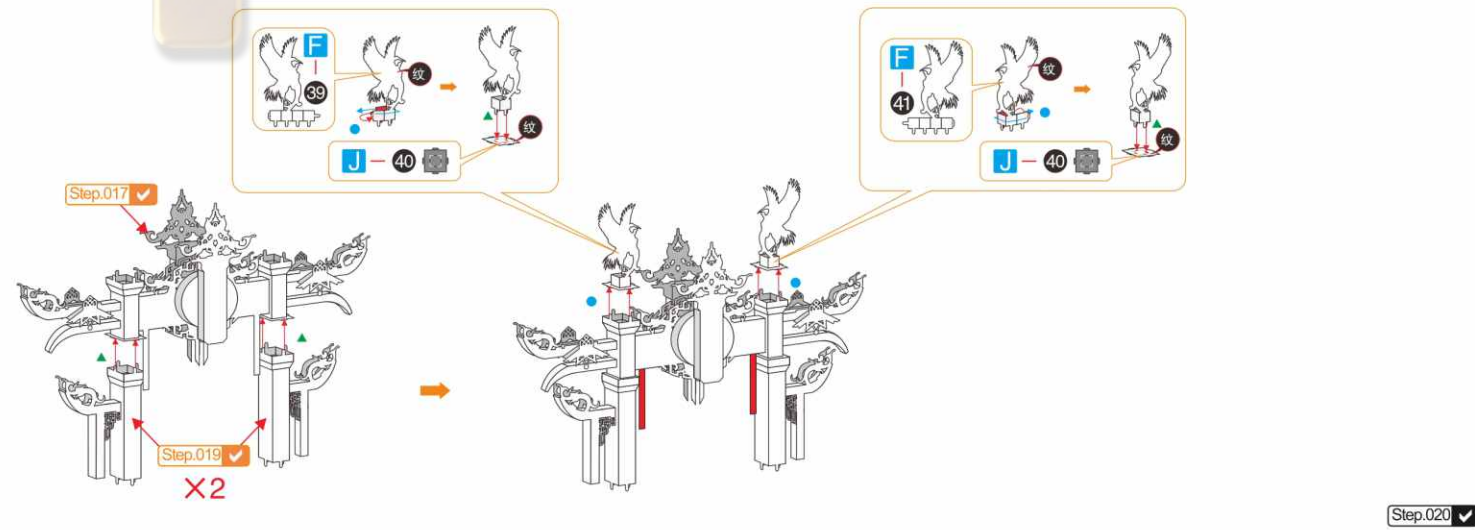

Step 021

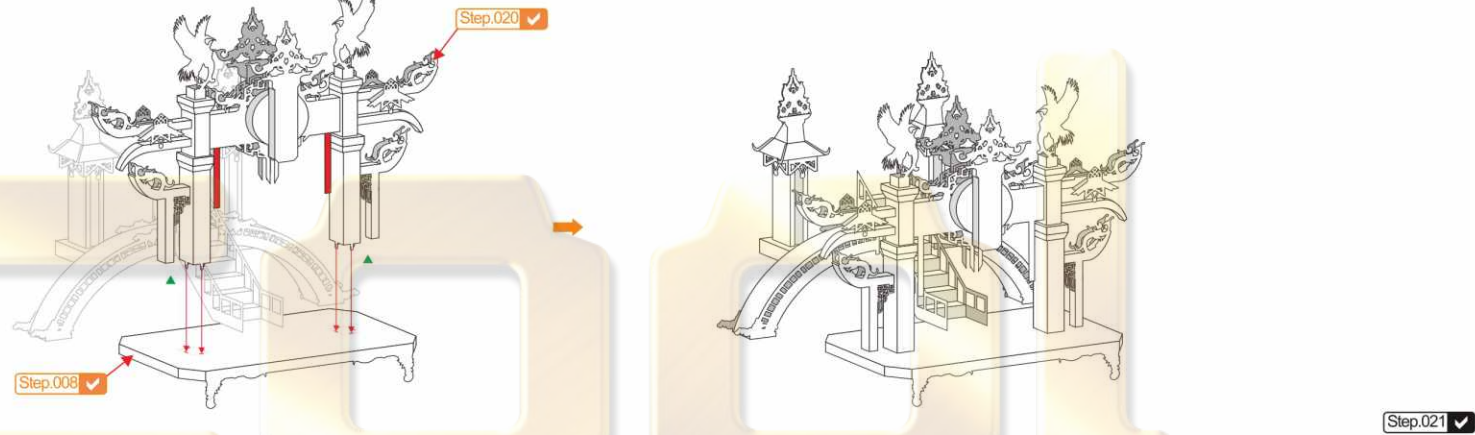

Step 022

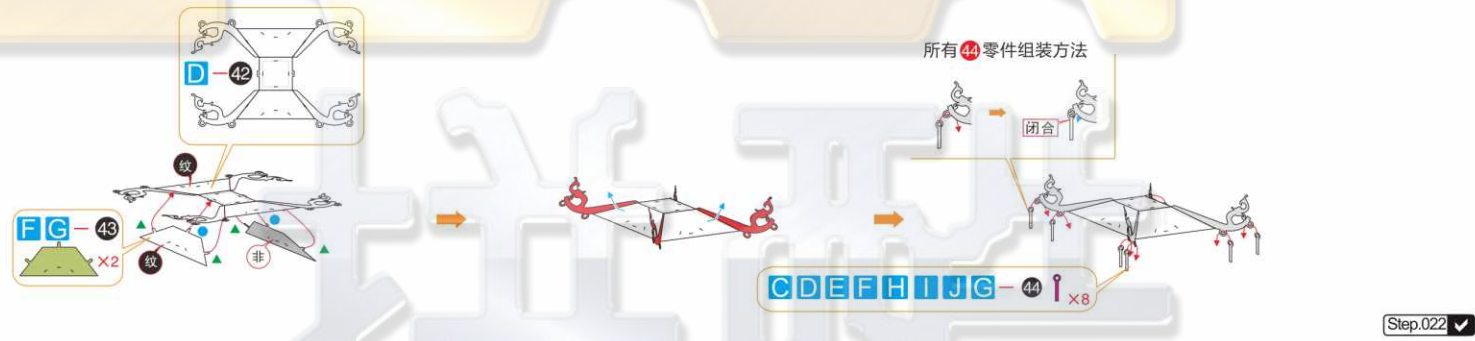

Step 023

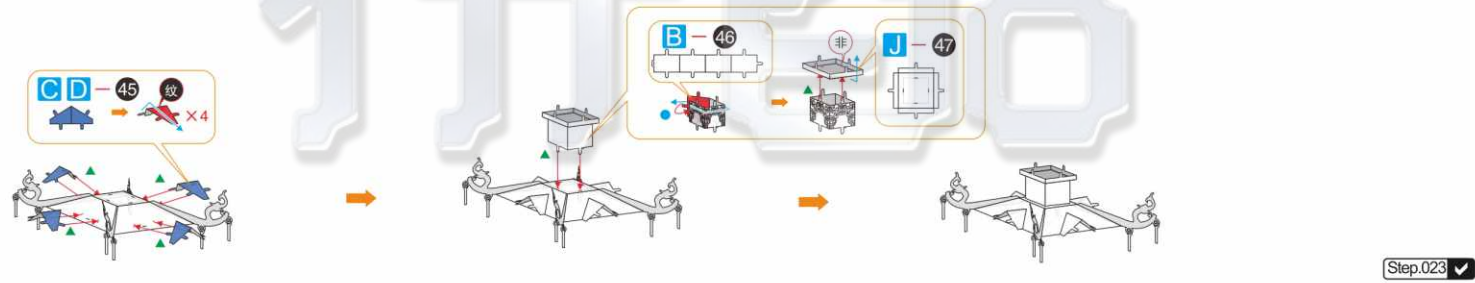

Step
024

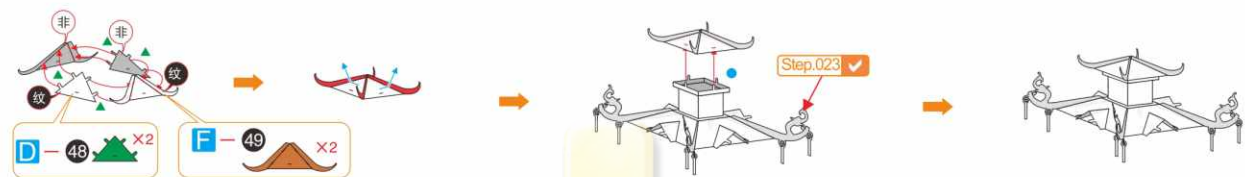

Step.024 ✓

Step
025



Step.025 ✓

Step
026



Step.026 ✓

Step
027

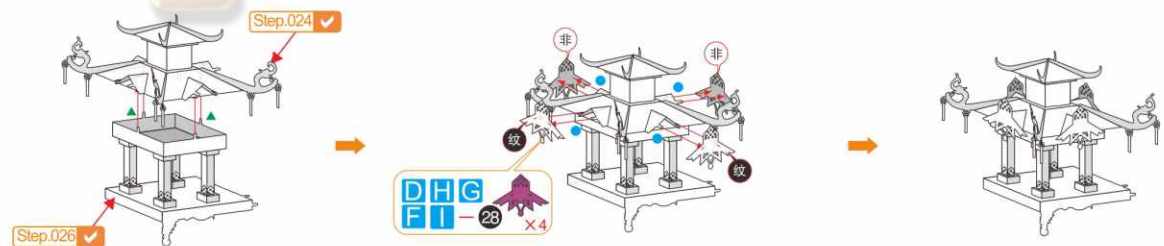

Step.027 ✓

Step
028

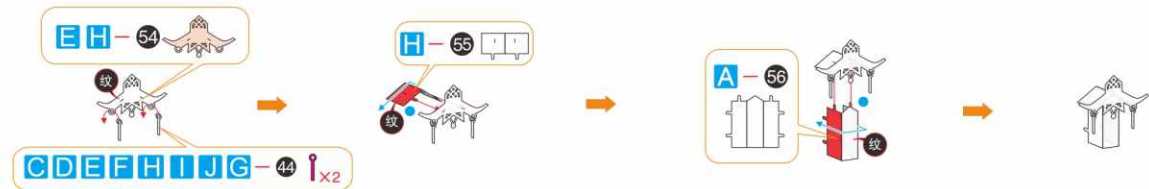

Step.028 ✓

Step
029

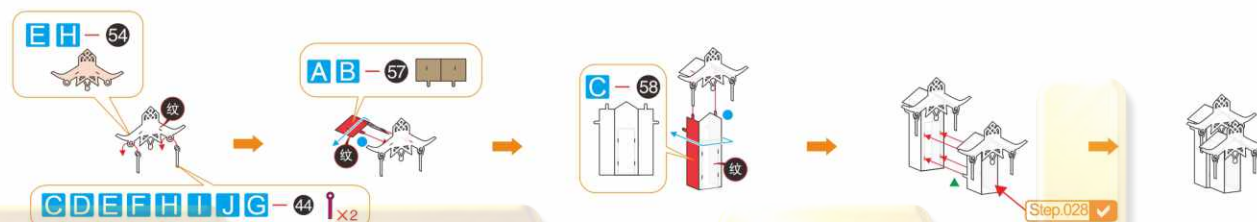

Step.029 ✓

Step
030

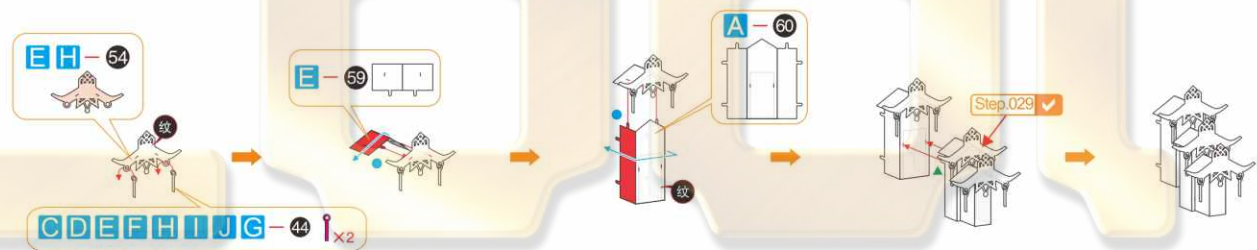

Step.030 ✓

Step
031

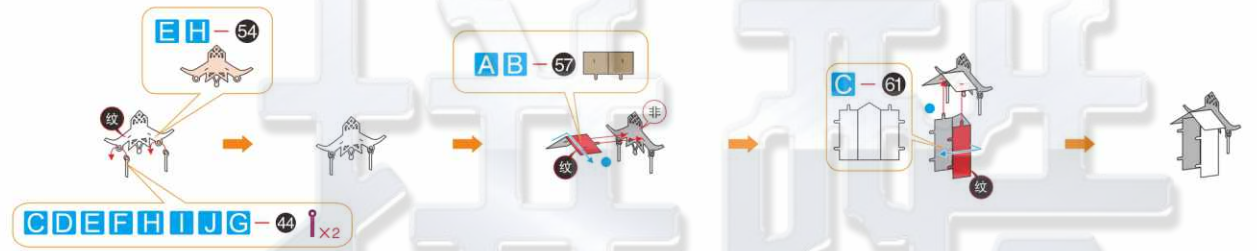

Step.031 ✓

Step
032



Step.032 ✓

Step 033

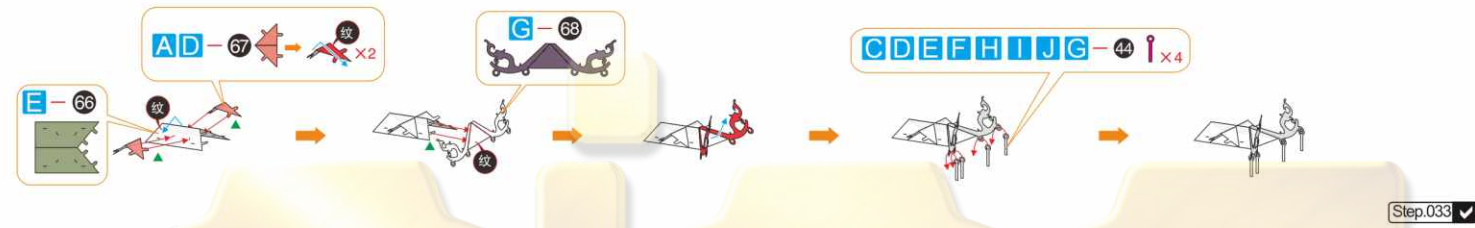

Step 034



Step 035

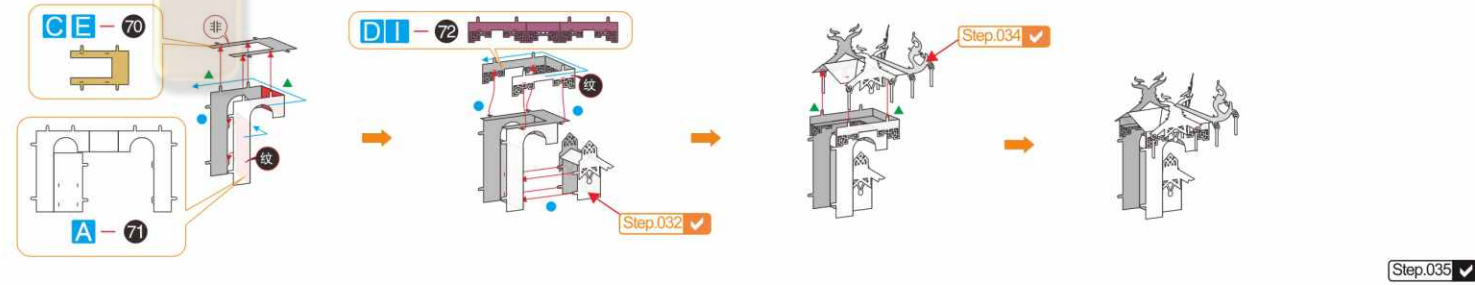

Step 036

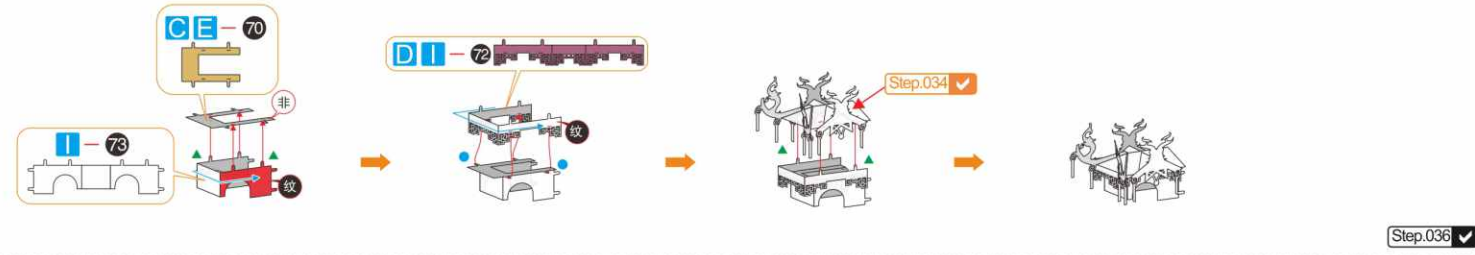

Step 037



Step 038

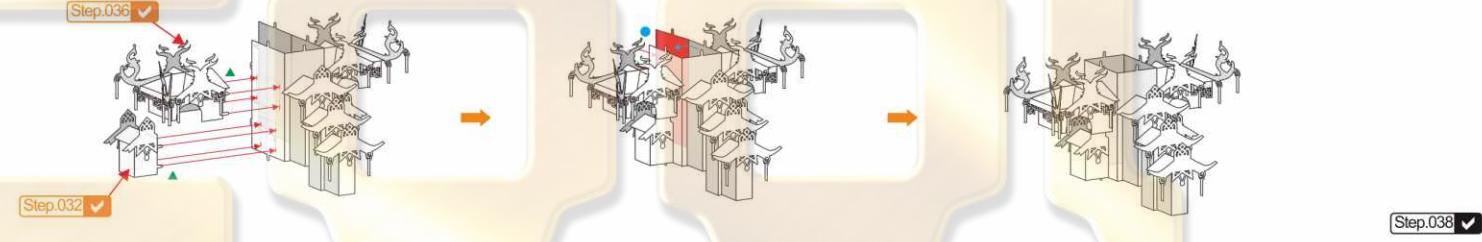

Step 039

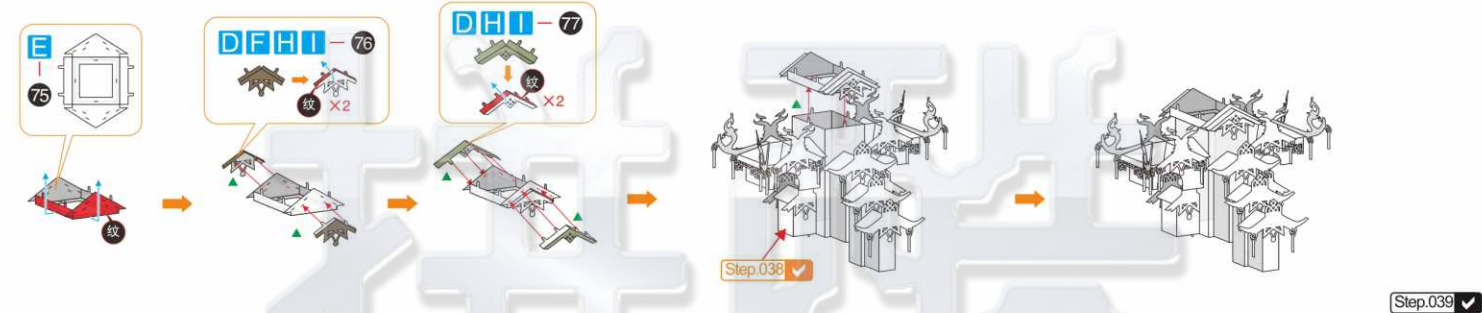

Step 040



Step 041

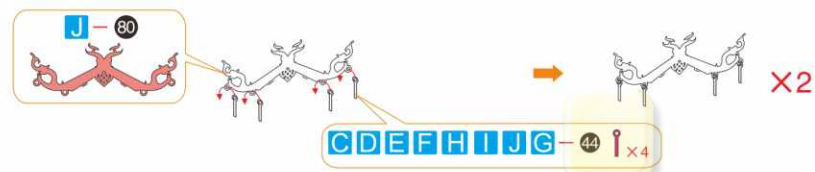

Step.041 ✓

Step 042

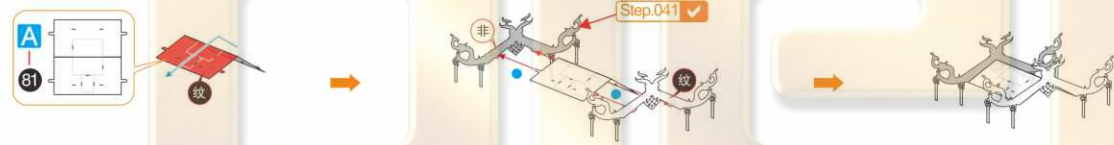

Step.042 ✓

Step 043

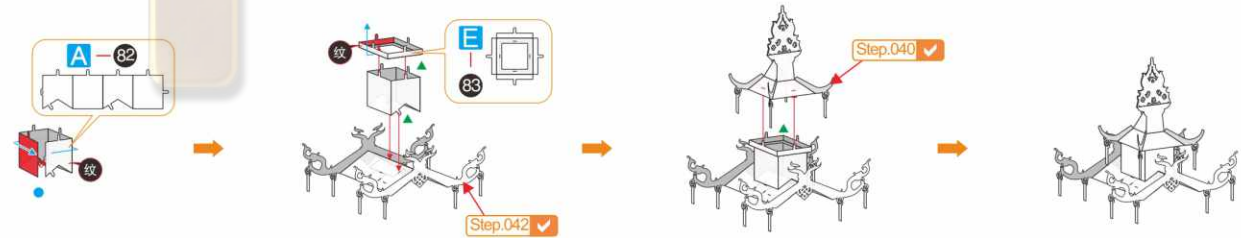

Step.043 ✓

Step 044

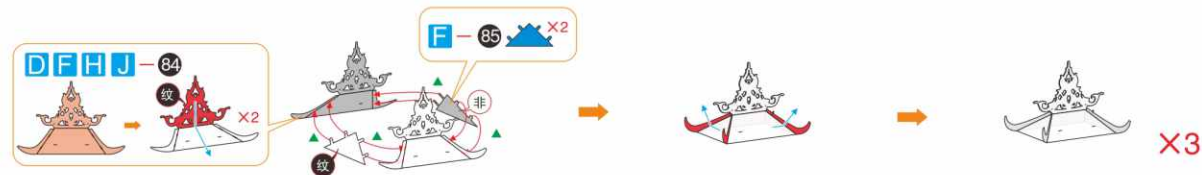

Step.044 ✓

Step 045

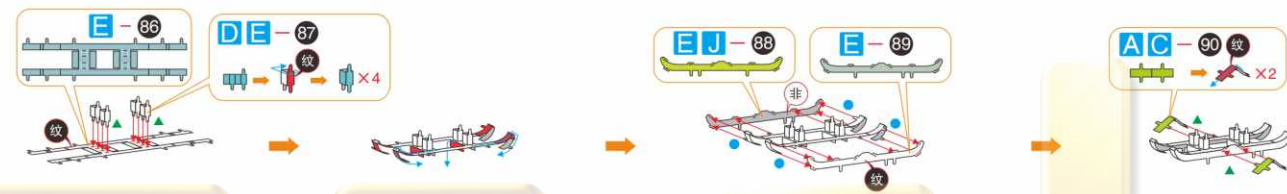

Step.045 ✓

Step 046



Step.046 ✓

Step 047

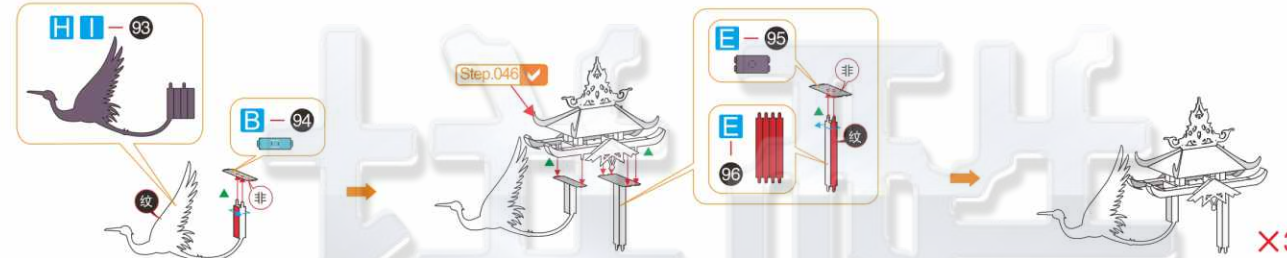

Step.047 ✓

Step 048



Step.048 ✓

Step 049

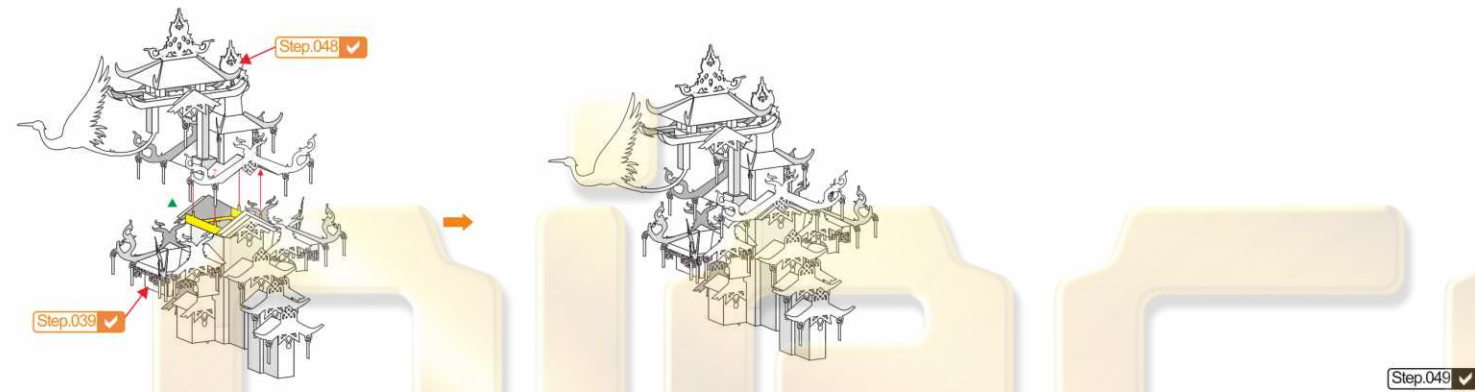

Step 050

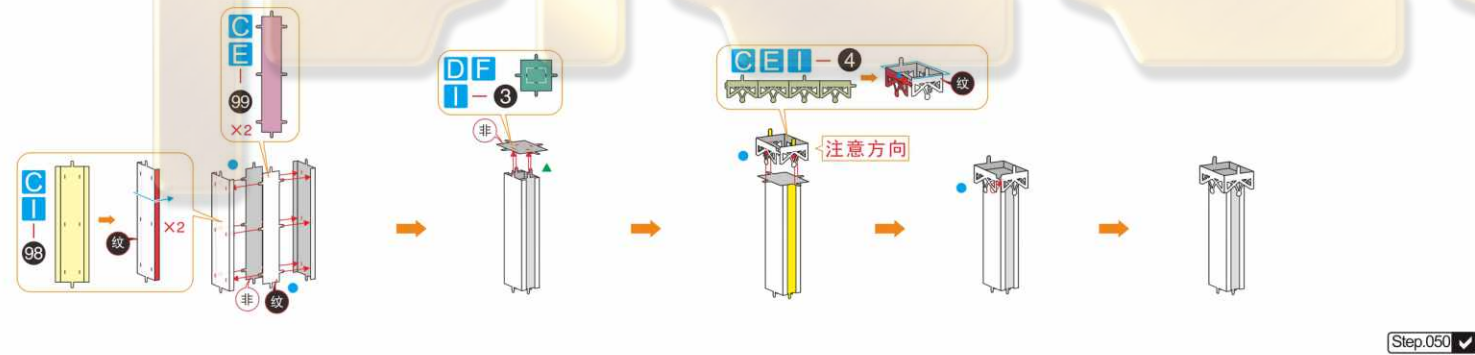

Step 051

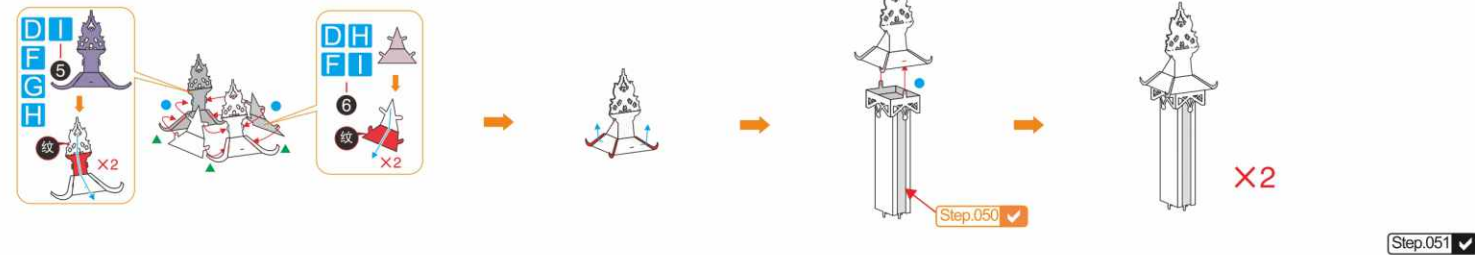

Step 052

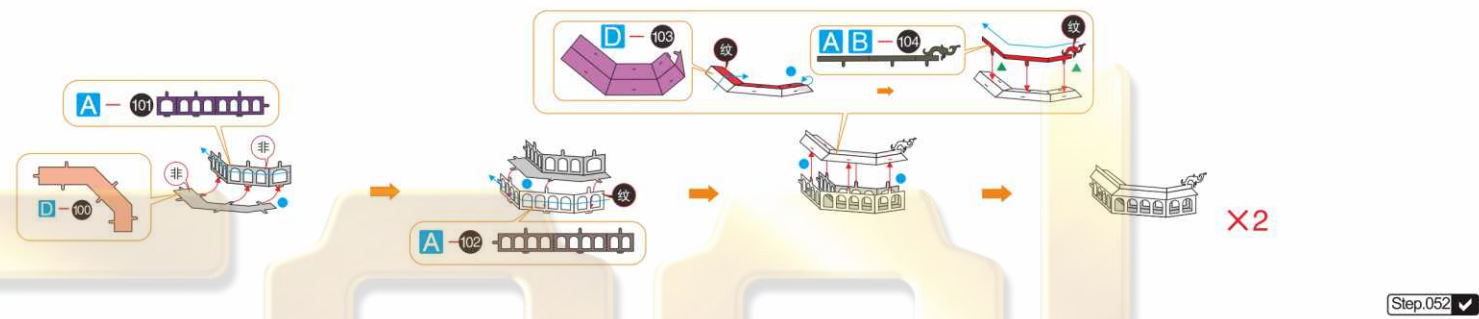

Step 053

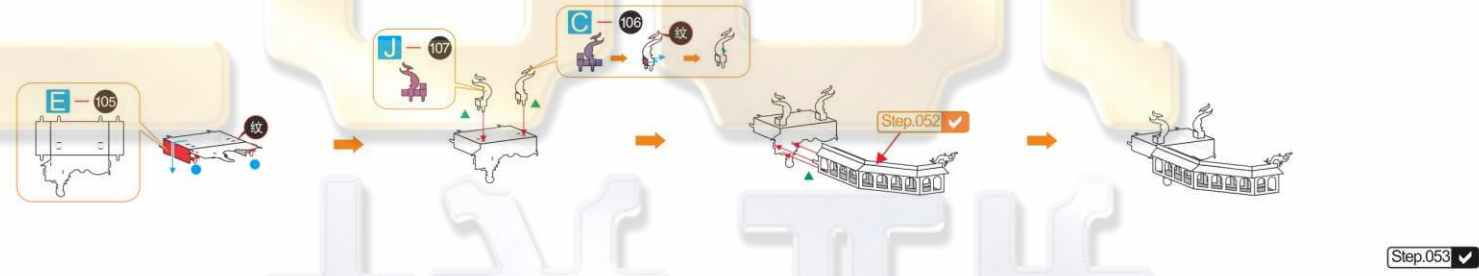

Step 054

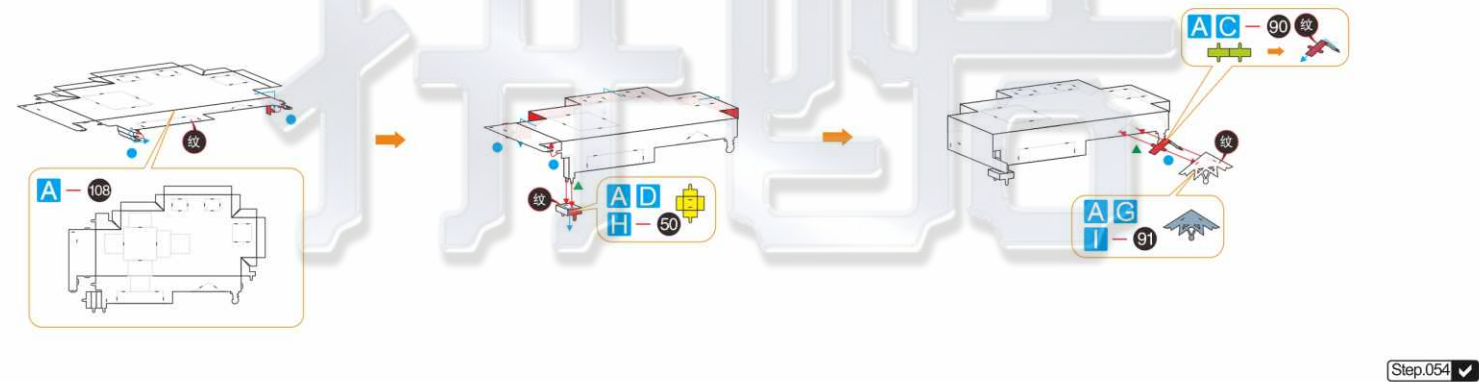

Step 055

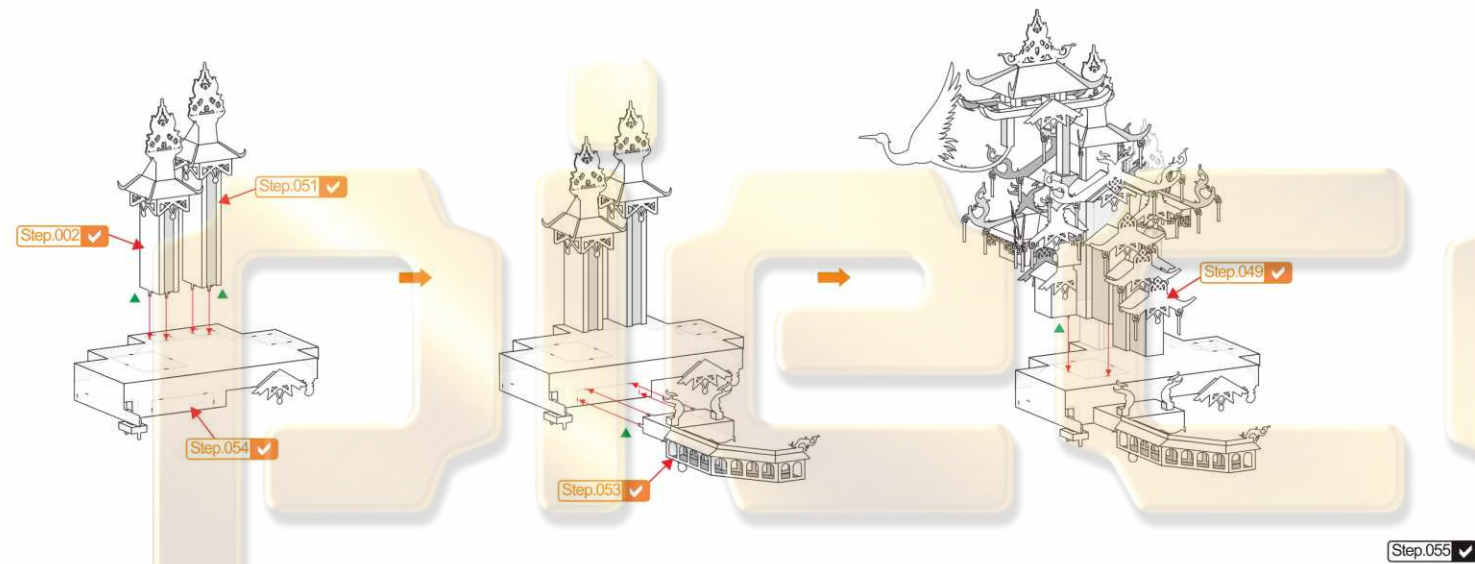

Step 056

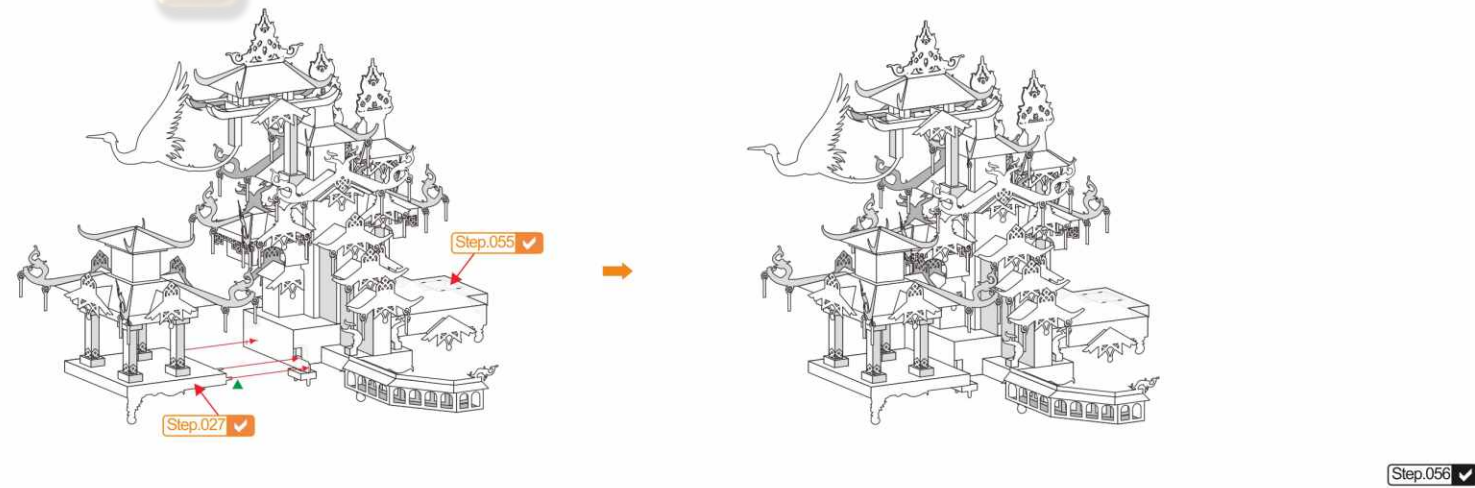

Step 057

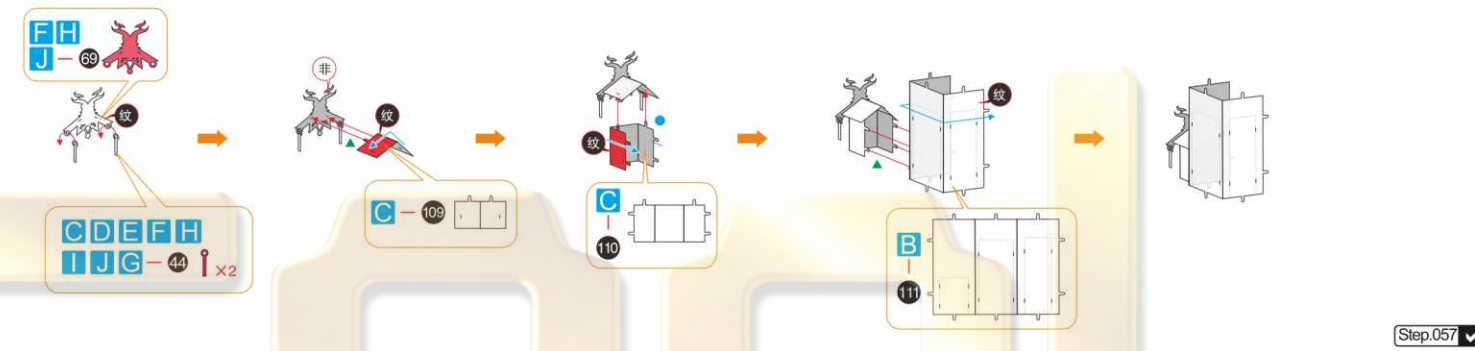

Step 058

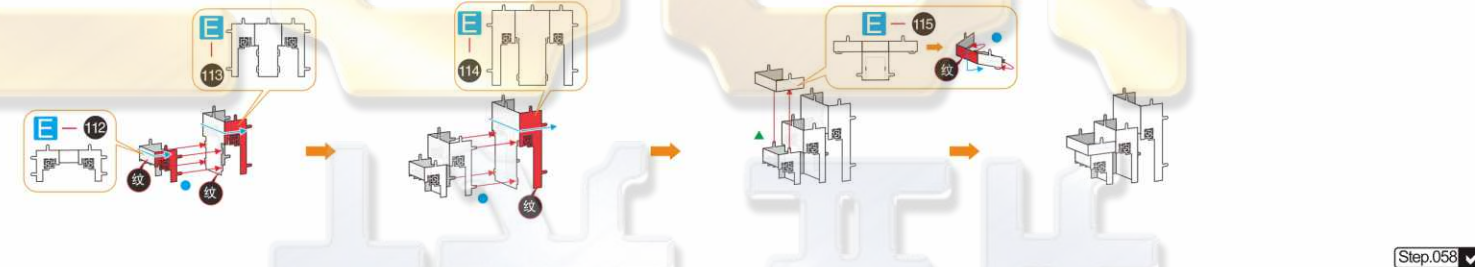

Step 059

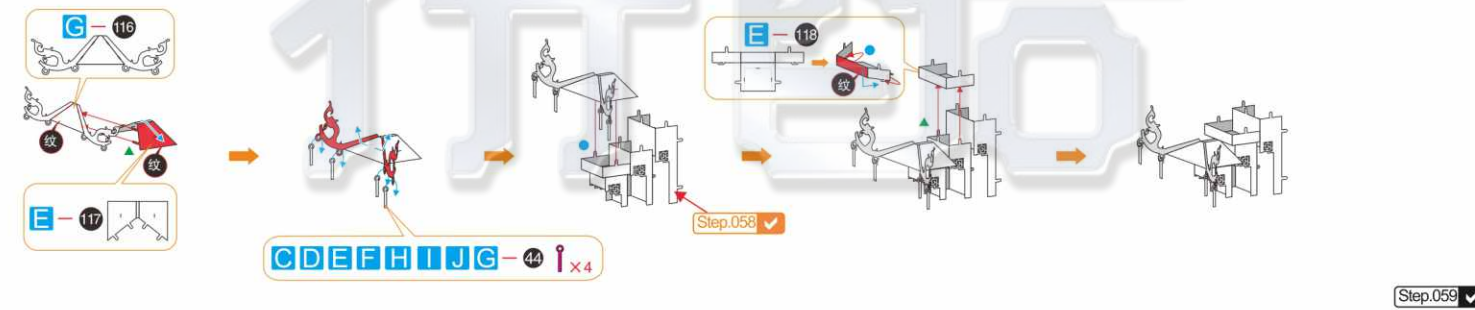

Step 060

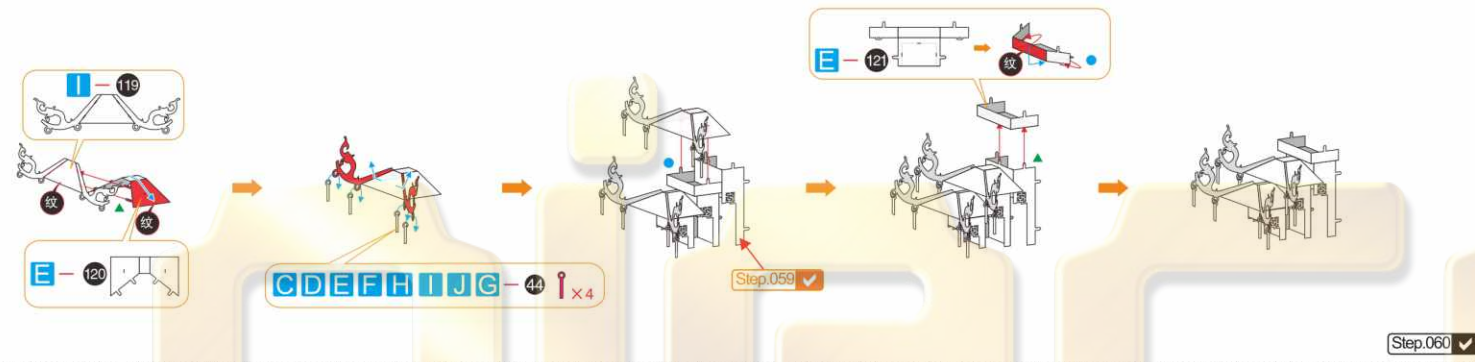

Step 061



Step 062

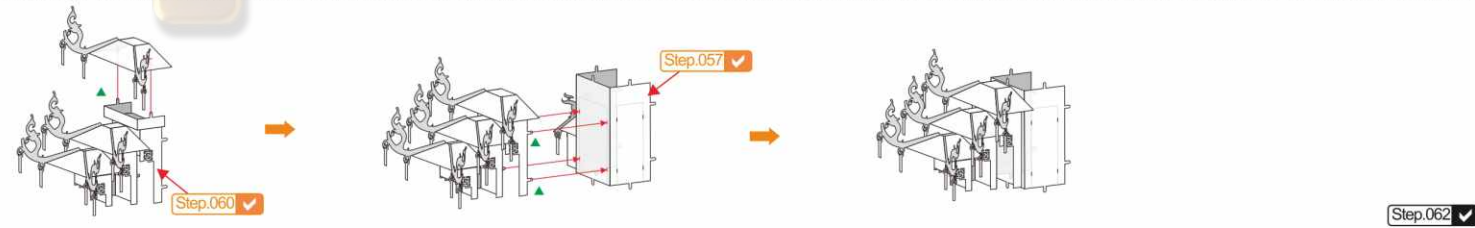

Step 063

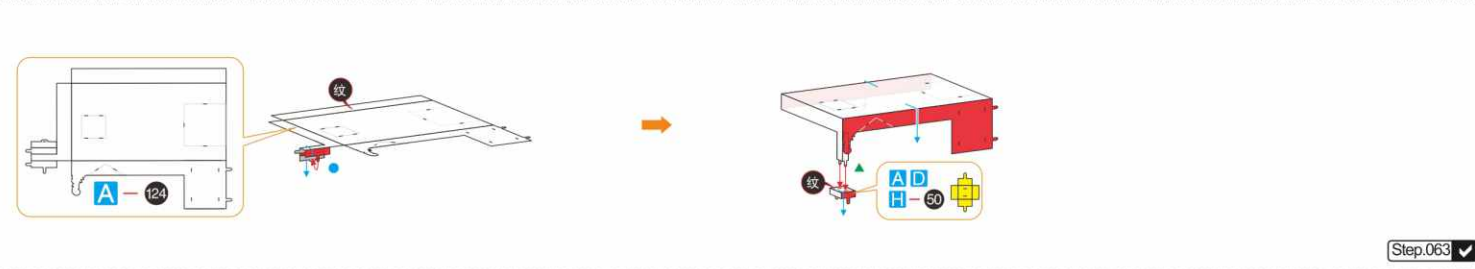

Step 064

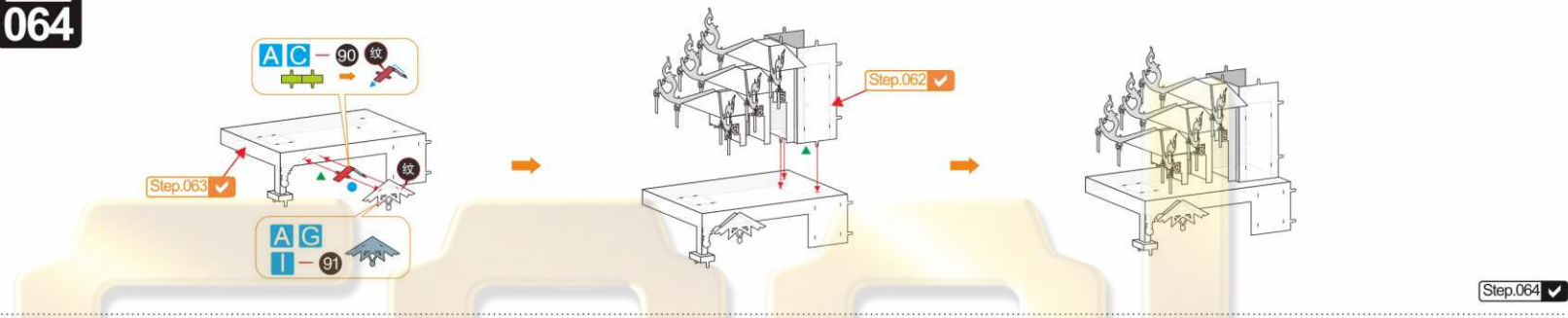

Step 065

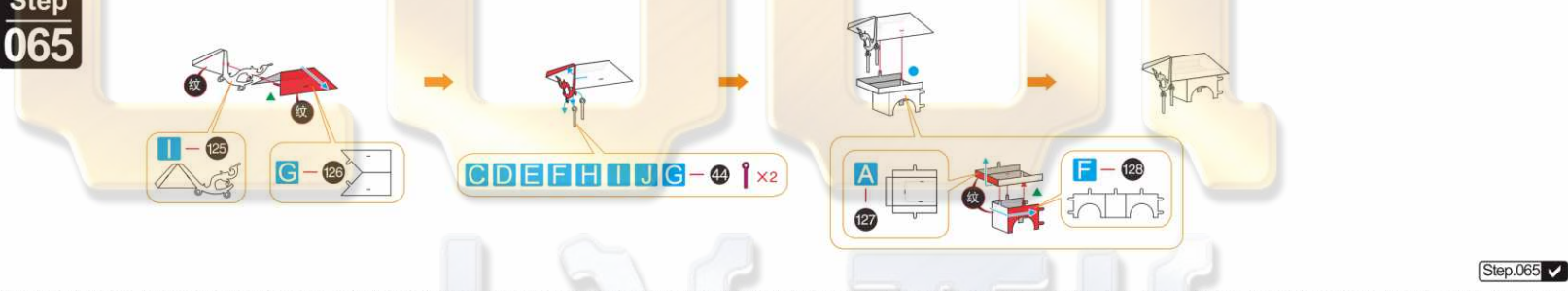

Step 066

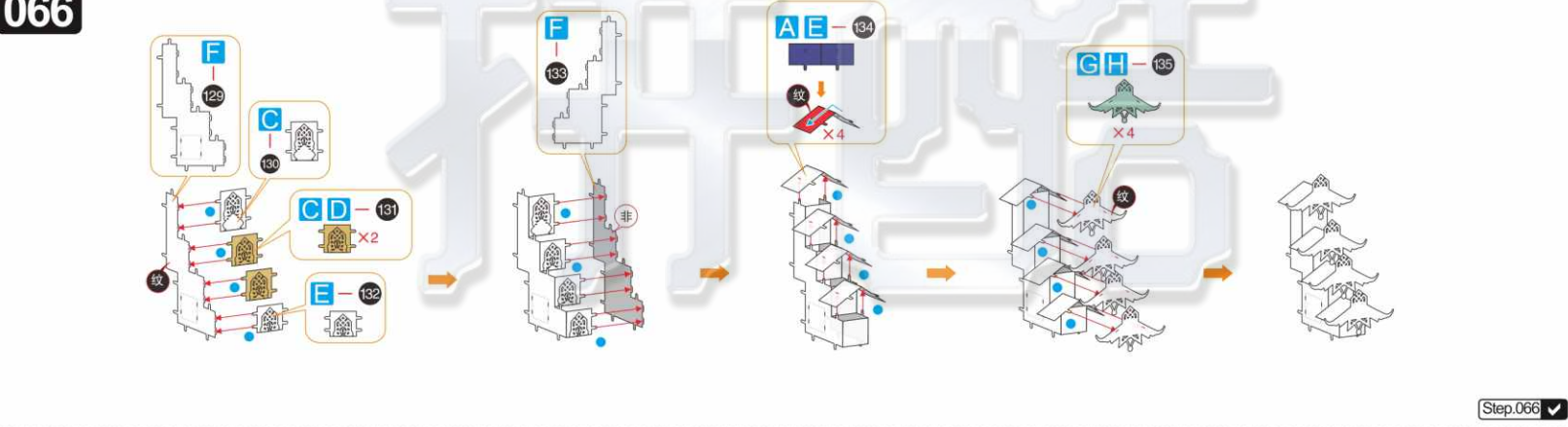

Step 067

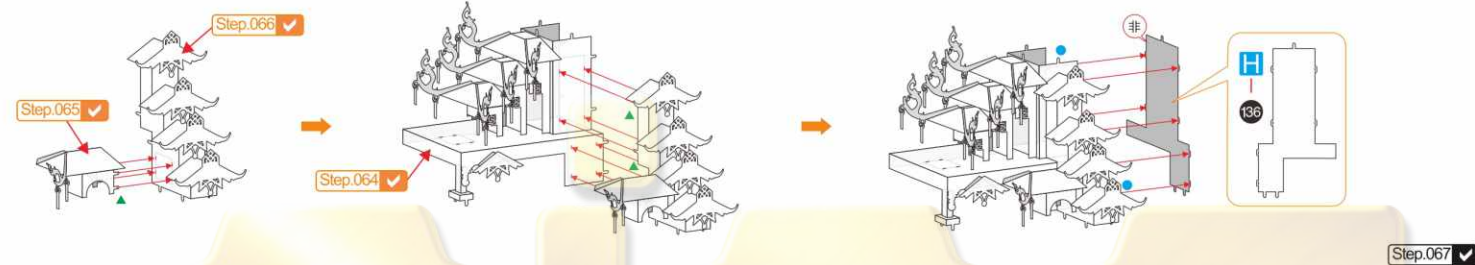

Step.067 ✓

Step 068



Step.068 ✓

Step 069

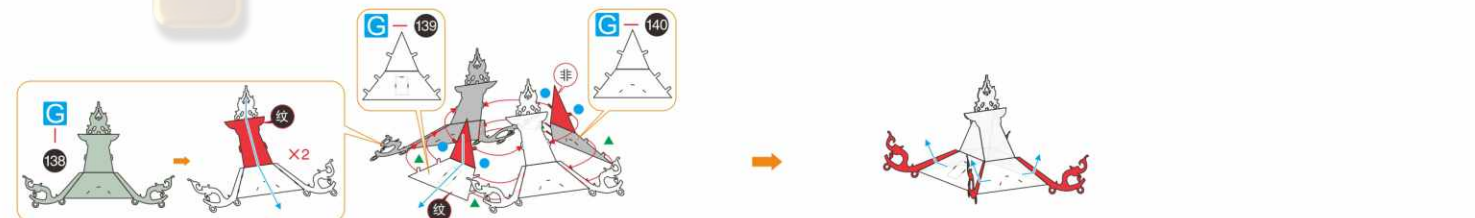

Step.069 ✓

Step 070



Step.070 ✓

Step 071

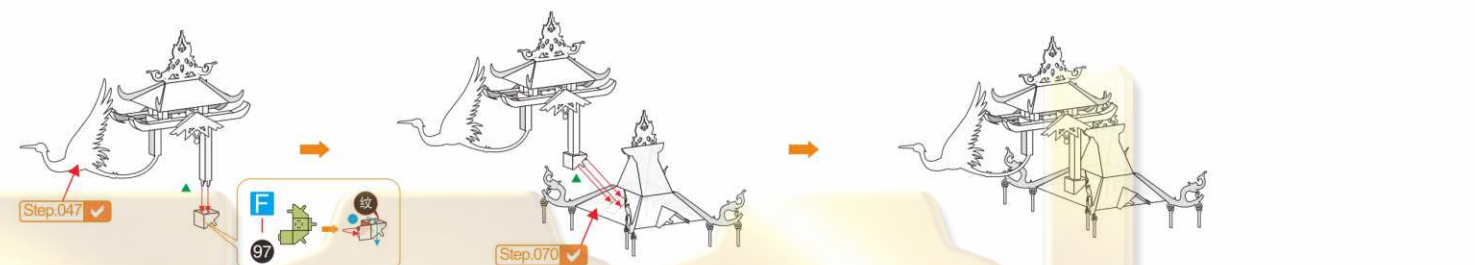

Step.071 ✓

Step 072



Step.072 ✓

Step 073

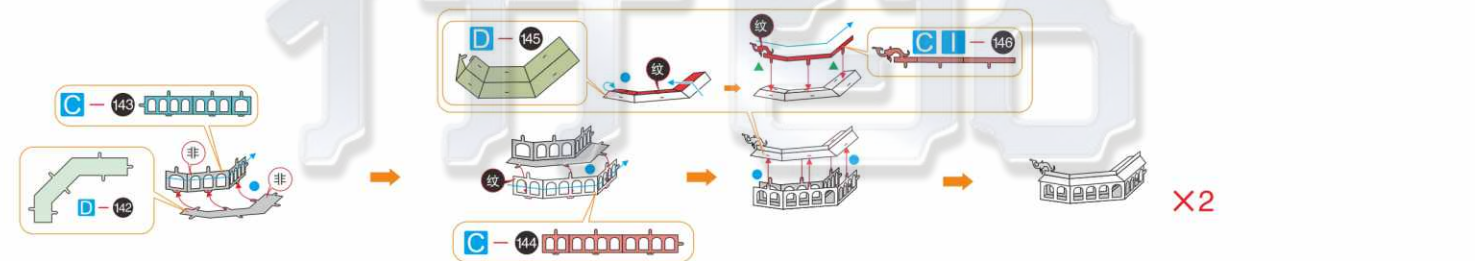

Step.073 ✓

Step 074

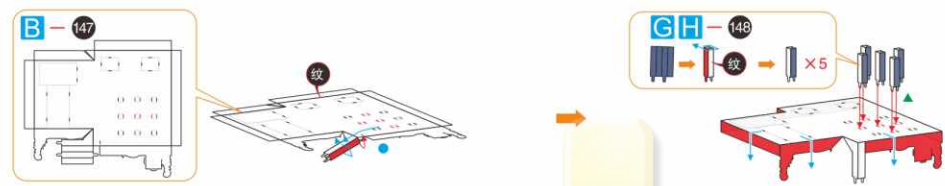

Step.074 ✓

Step 075

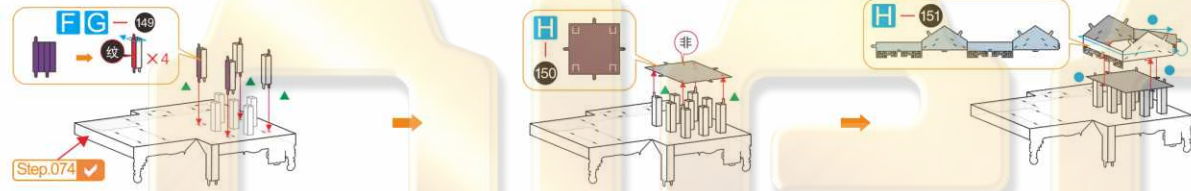

Step.075 ✓

Step 076

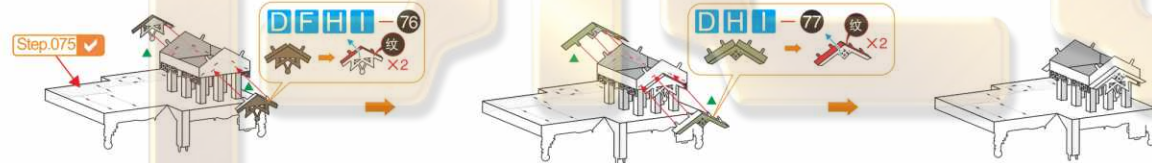

Step.076 ✓

Step 077



Step.077 ✓

Step 078

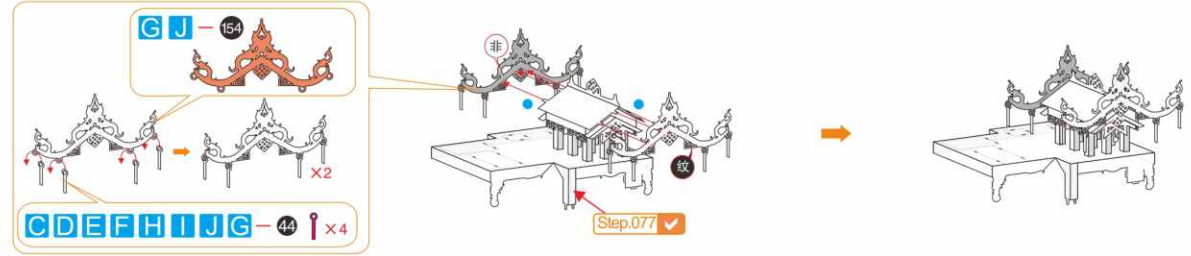

Step.078 ✓

Step 079

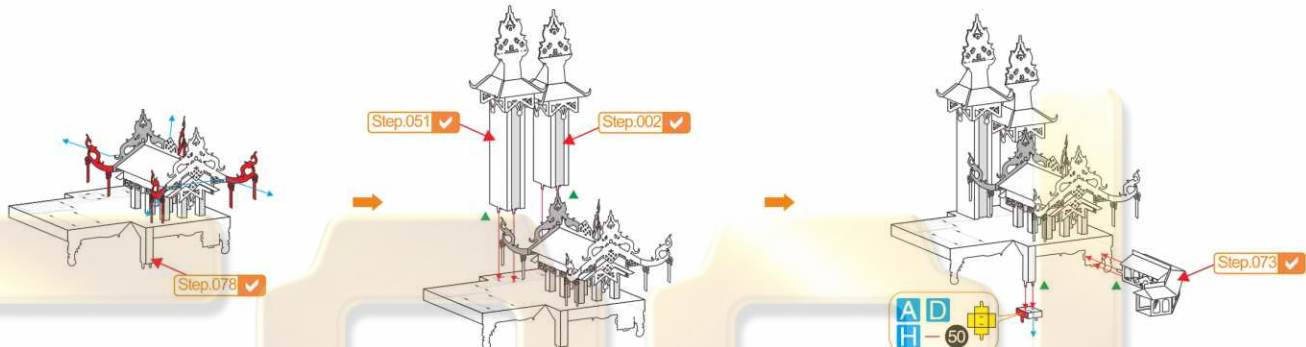

Step.079 ✓

Step 080



Step.080 ✓

Step 081

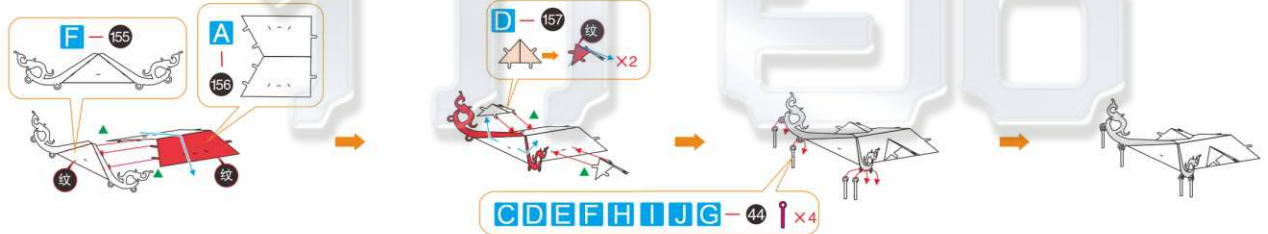

Step.081 ✓

Step 082

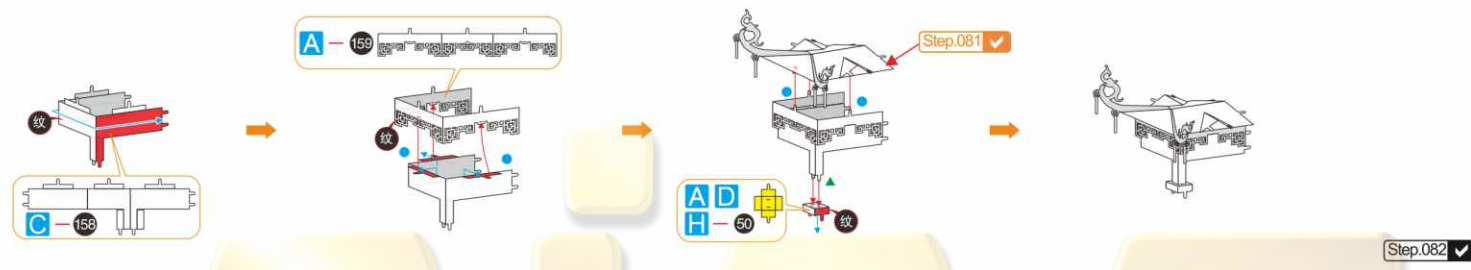

Step.082 ✓

Step 083

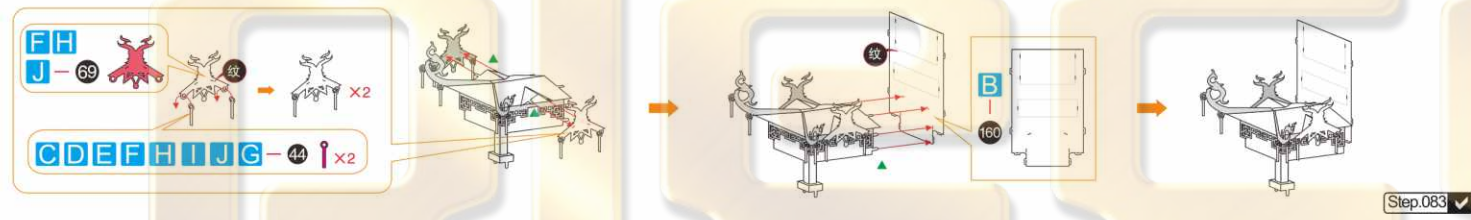

Step.083 ✓

Step 084

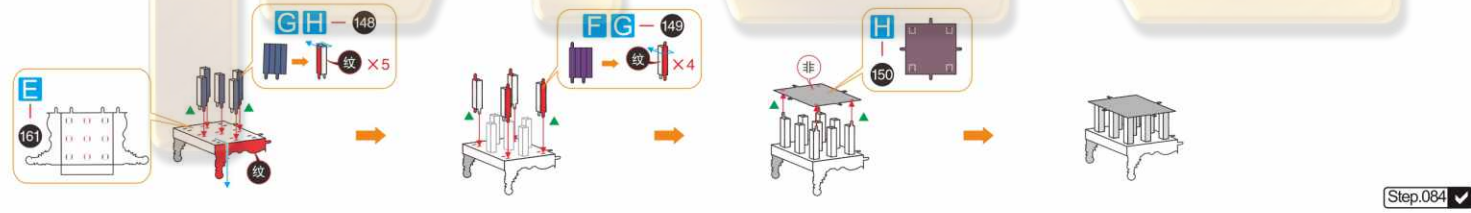

Step.084 ✓

Step 085

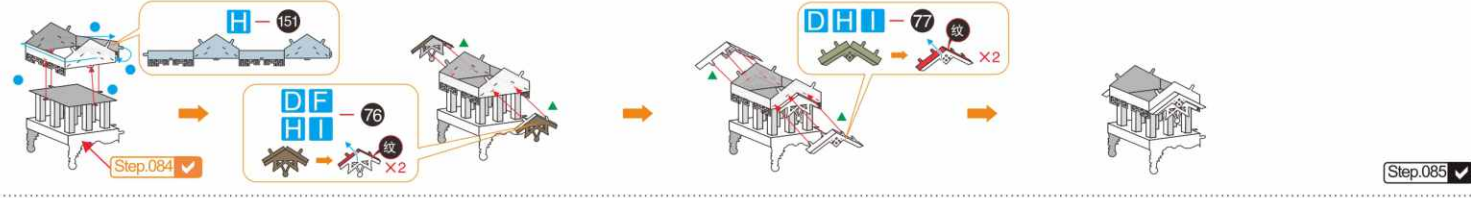

Step.085 ✓

Step 086



Step.086 ✓

Step 087



Step.087 ✓

Step 088



Step.088 ✓

Step 089

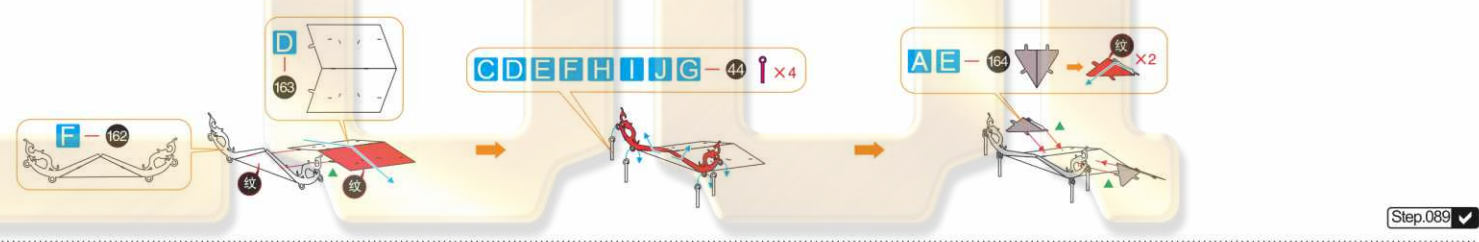

Step.089 ✓

Step 090

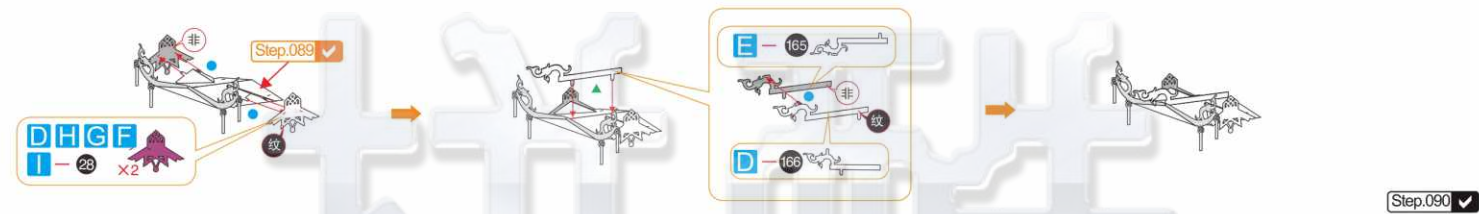

Step.090 ✓

Step 091

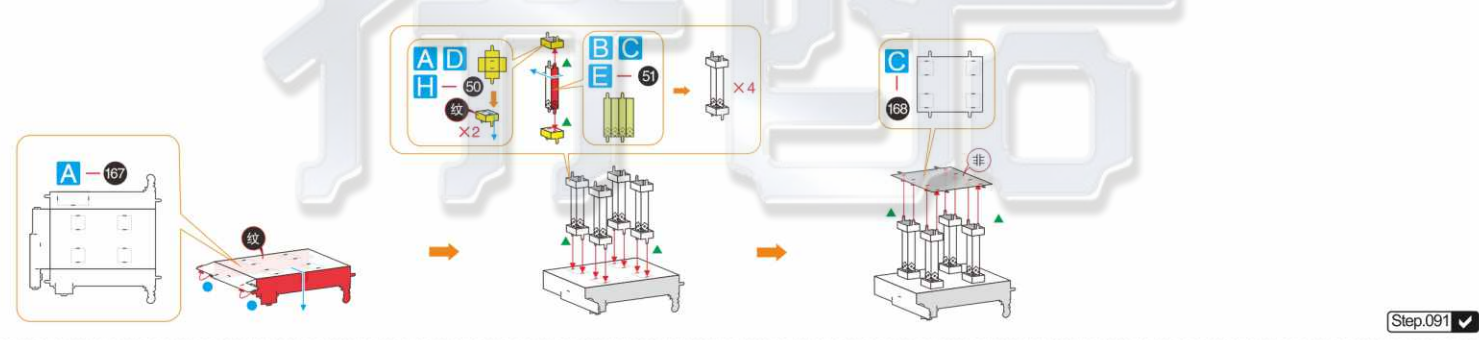

Step.091 ✓

Step 092

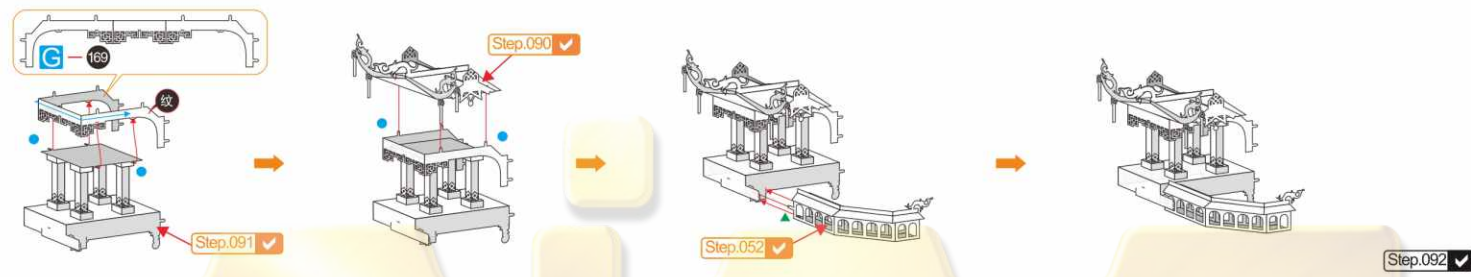

Step 093

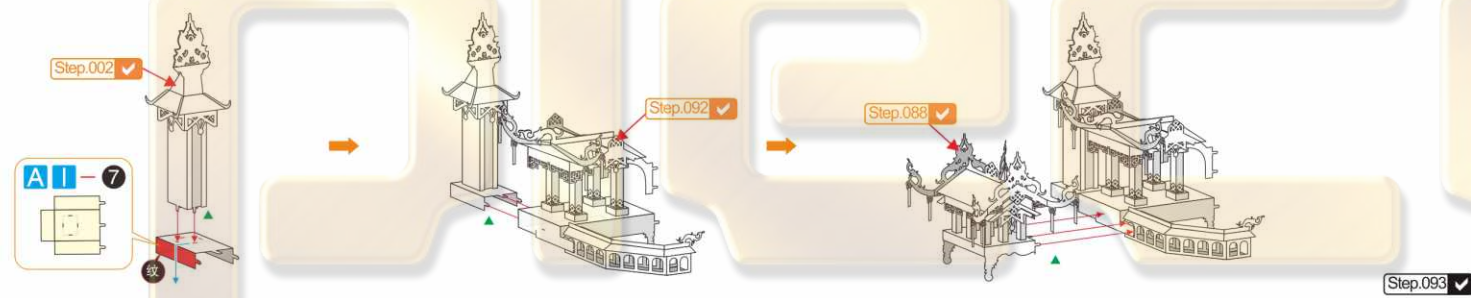

Step 094



Step 095

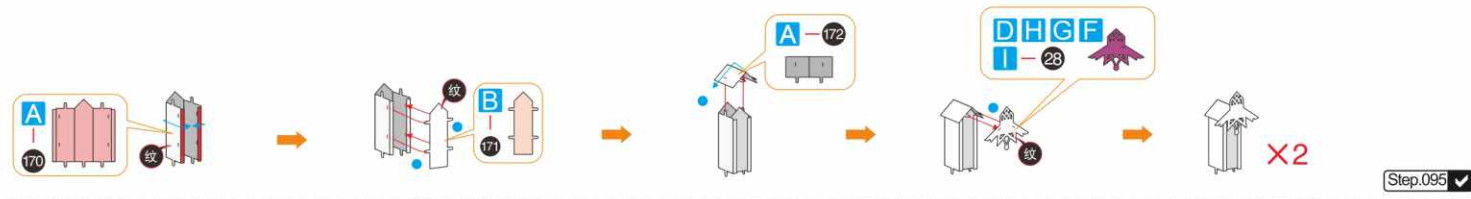

Step 096

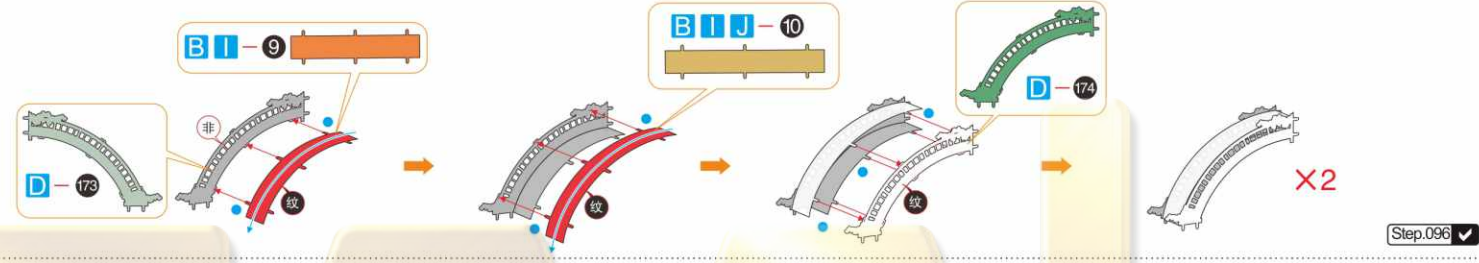

Step 097

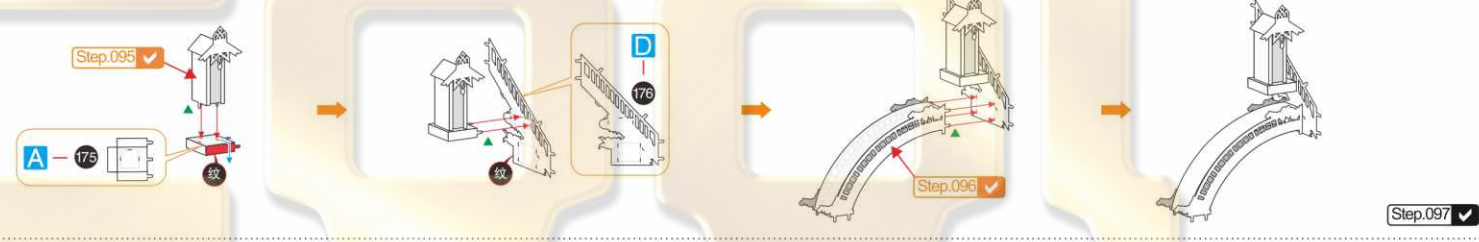

Step 098

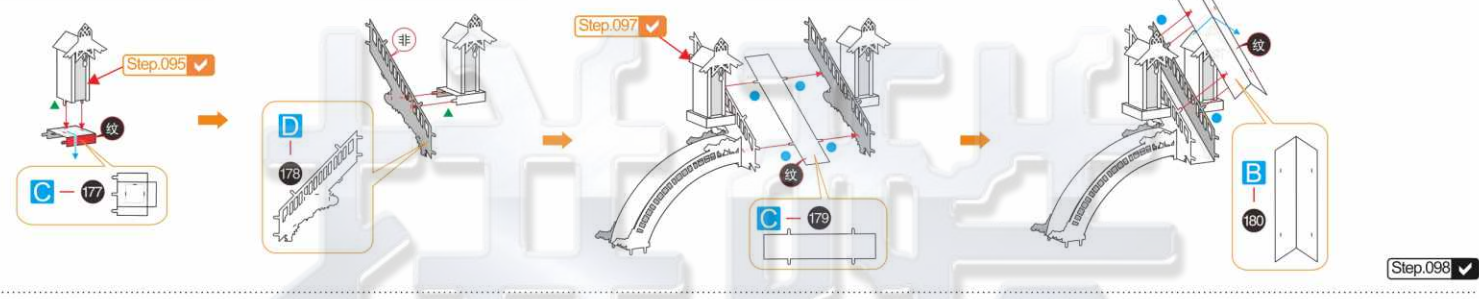

Step 099

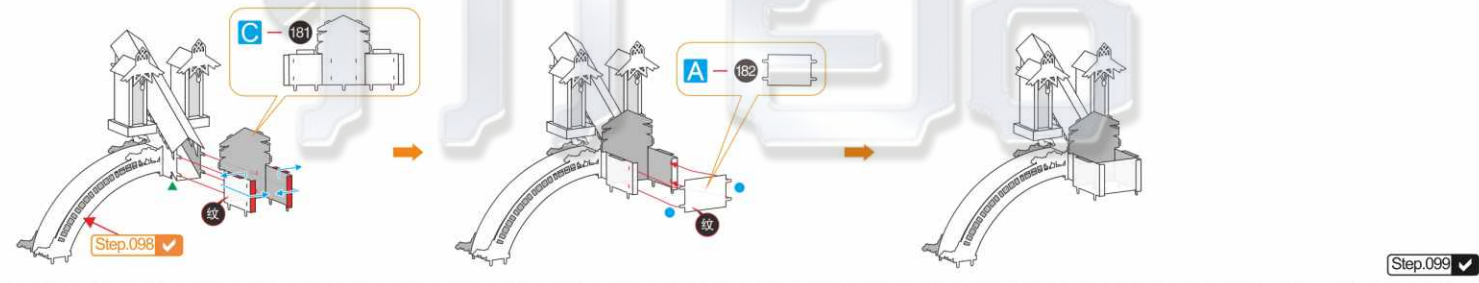

Step 100

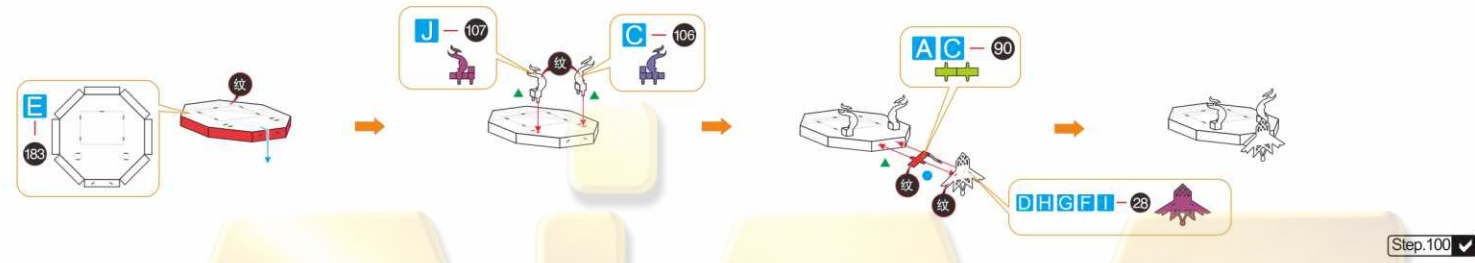

Step 101

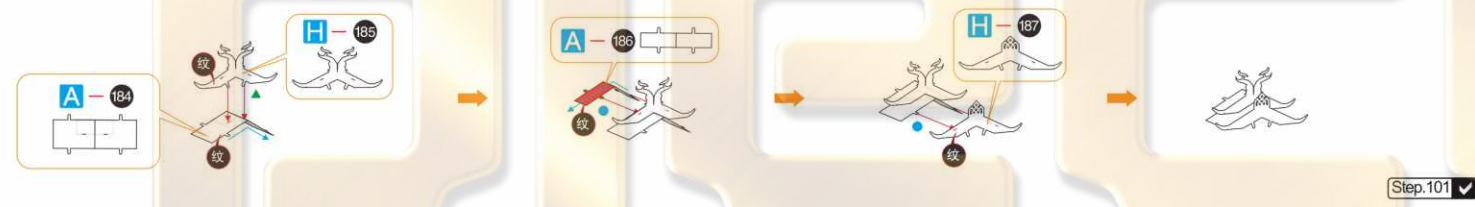

Step 102

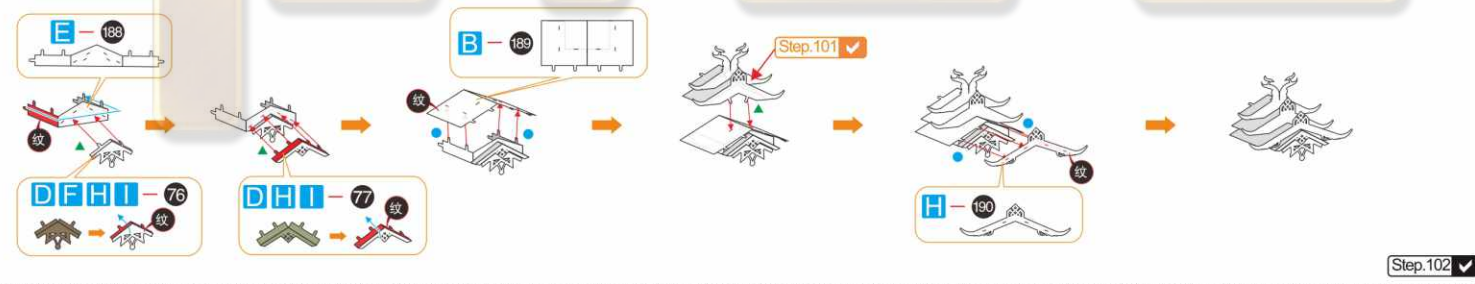

Step 103

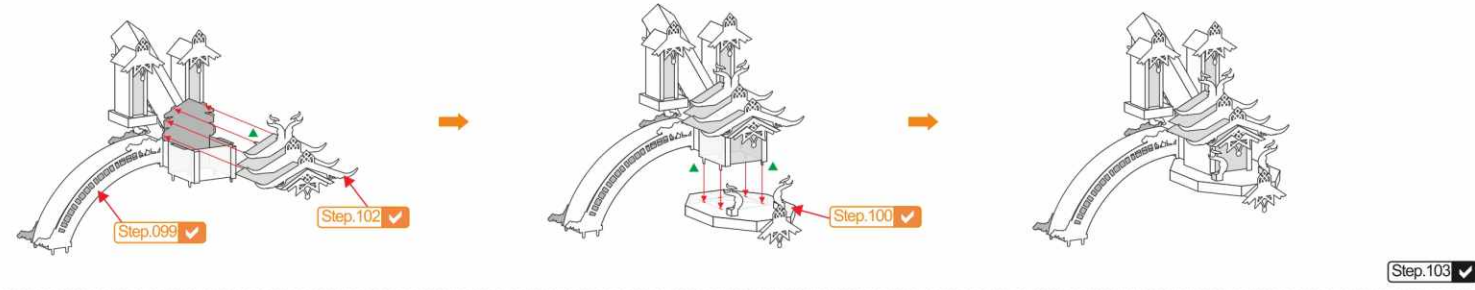

Step 104

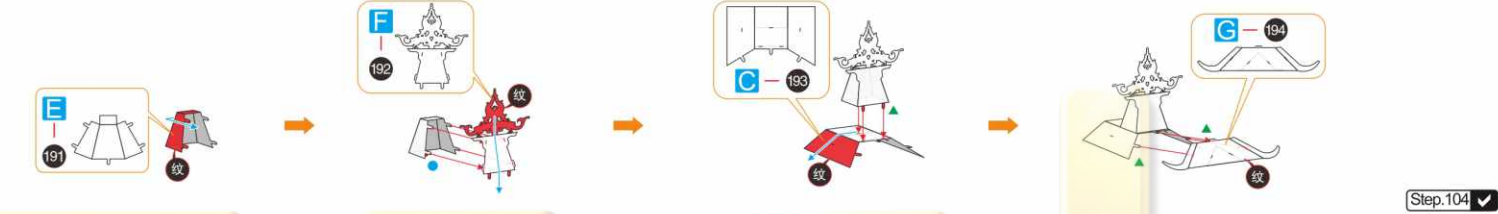

Step 105

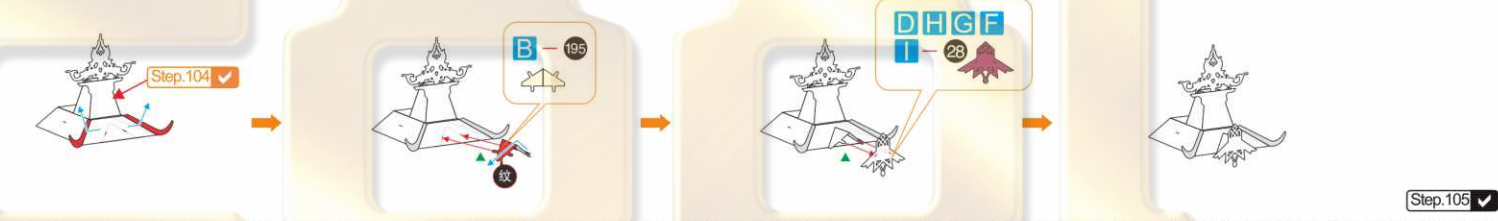

Step 106



Step 107



Step 108



Step 109

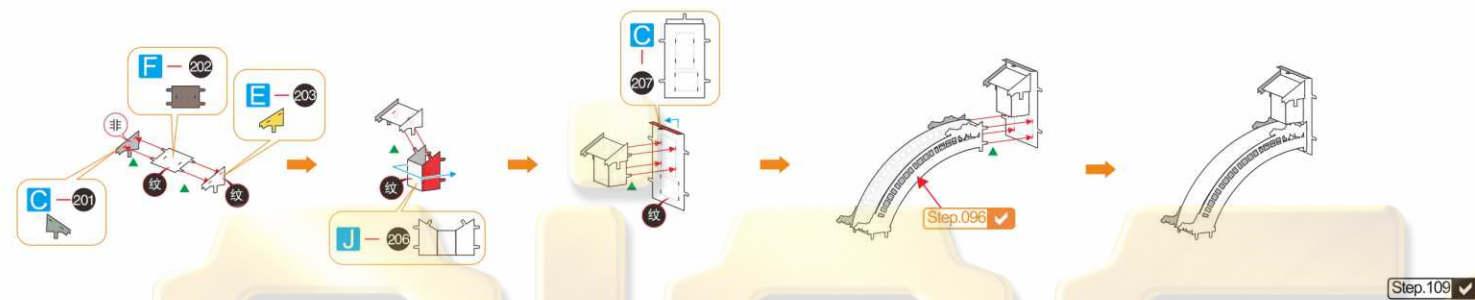

Step 110

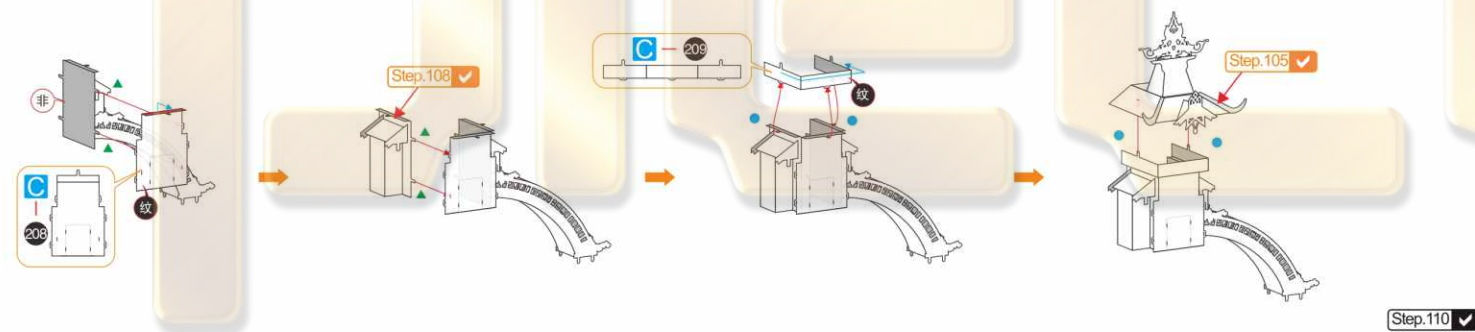

Step 111

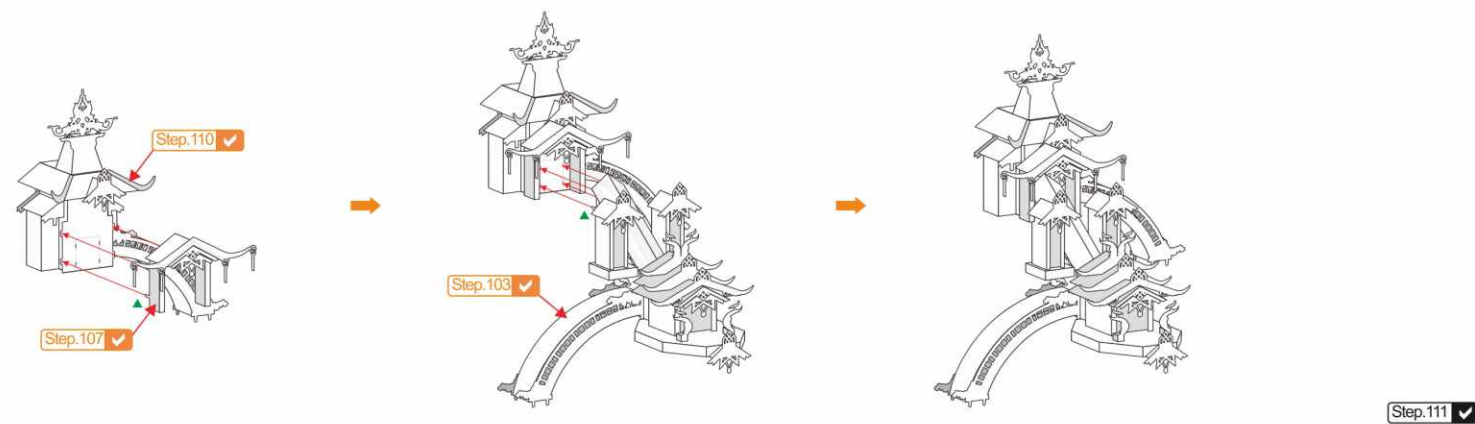

Step 112

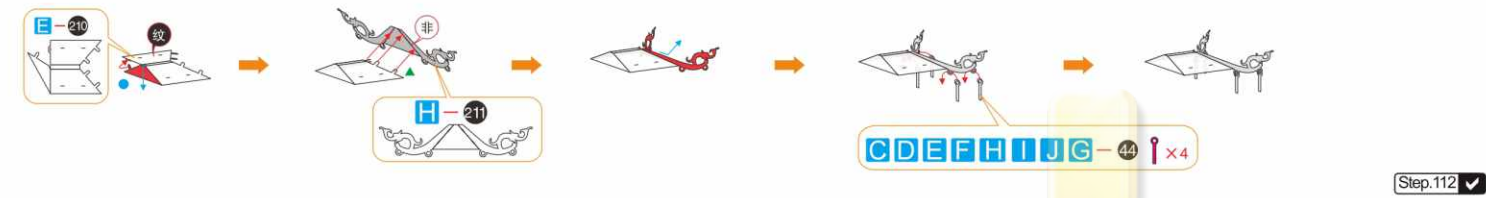

Step 113

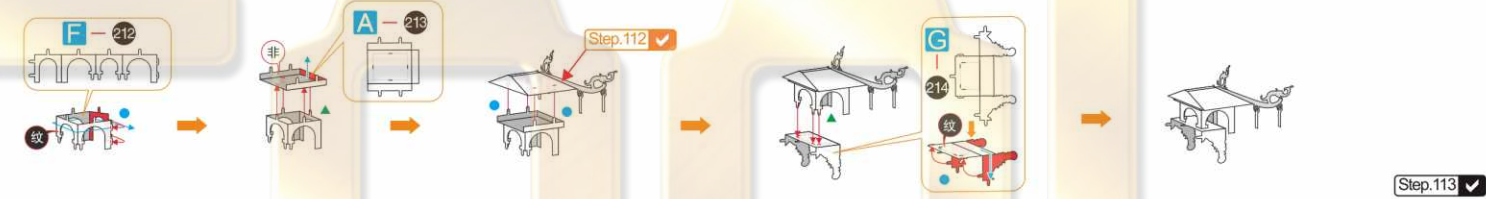

Step 114



Step 115



Step 116

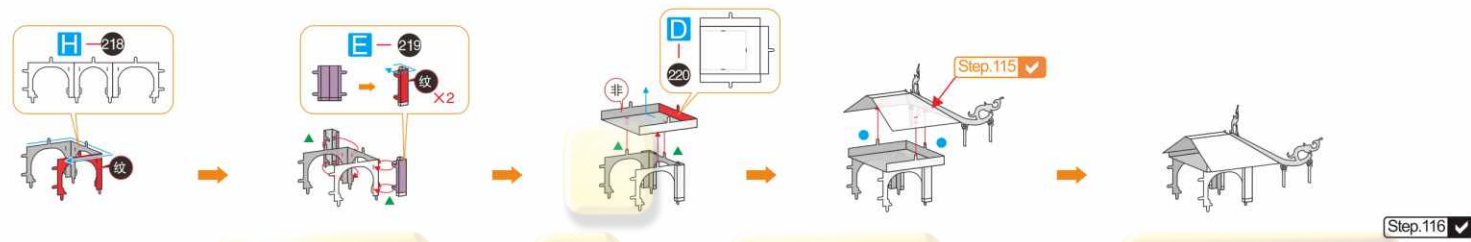

Step 117



Step 118

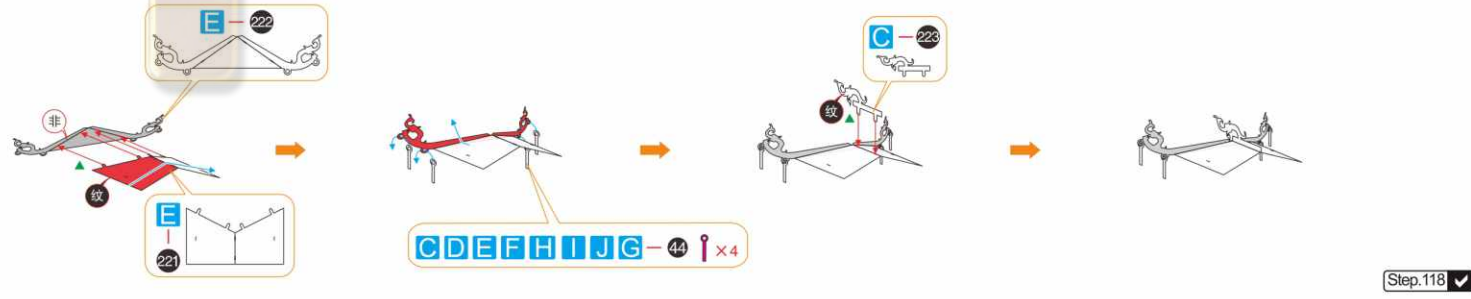

Step 119

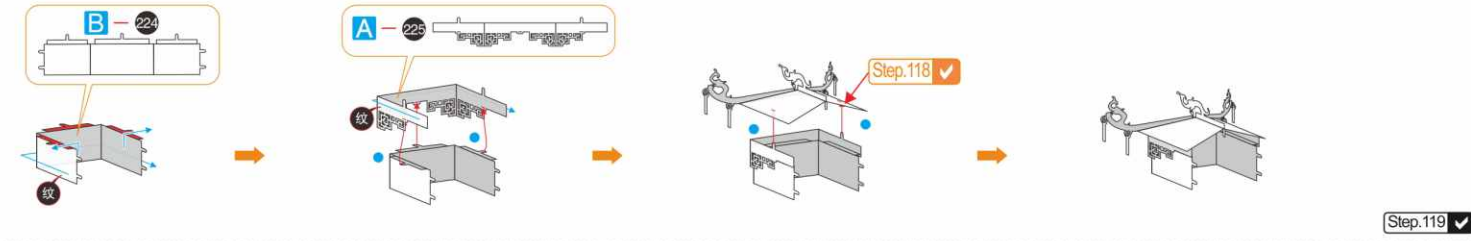

Step 120

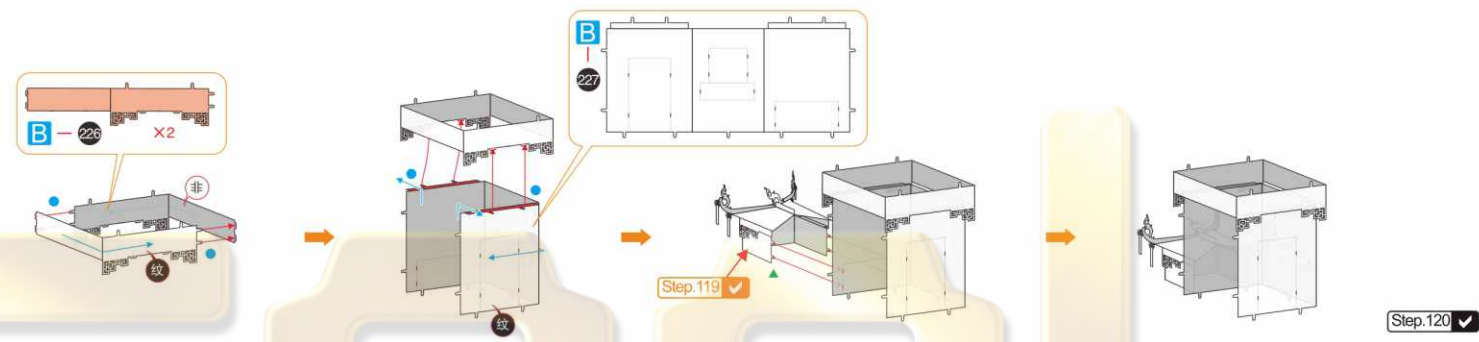

Step 121

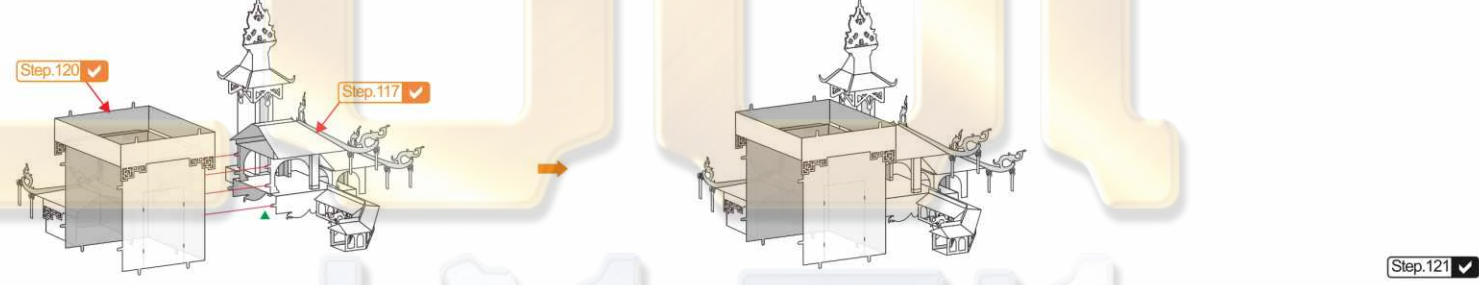

Step 122

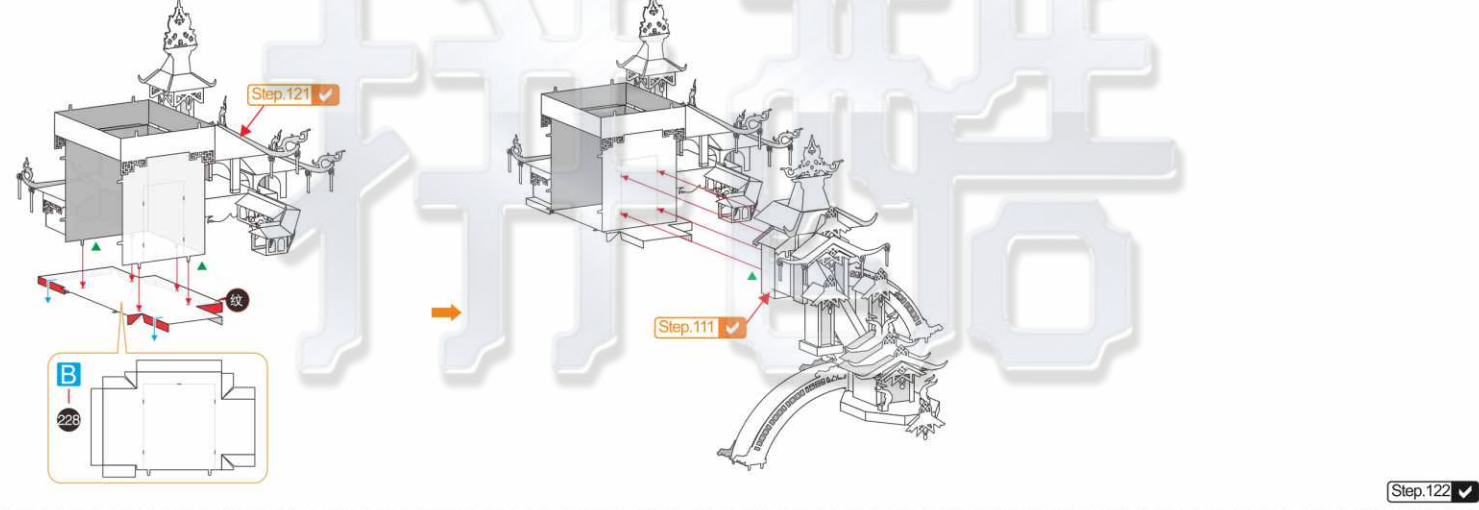

Step 123



Step.123 ✓

Step 124

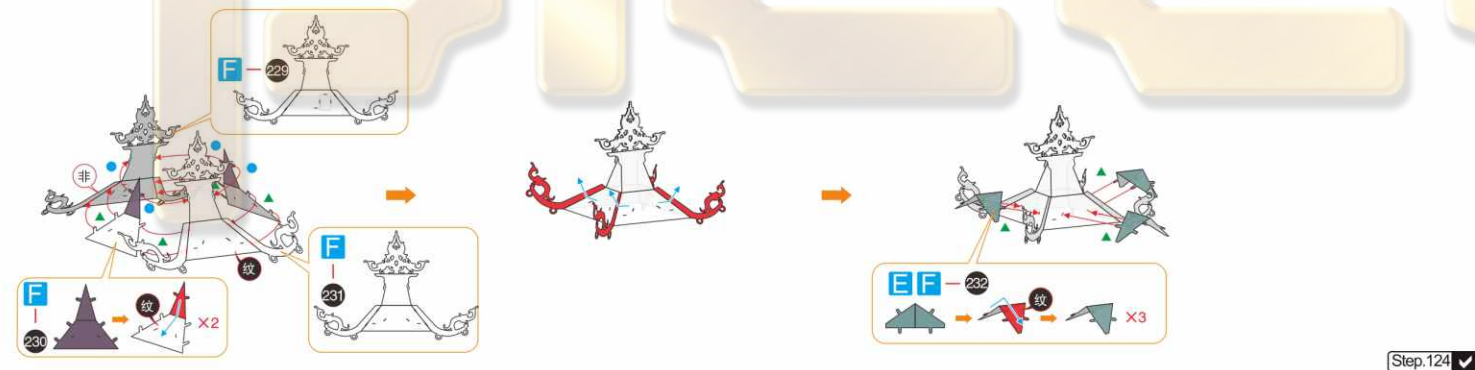

Step.124 ✓

Step 125

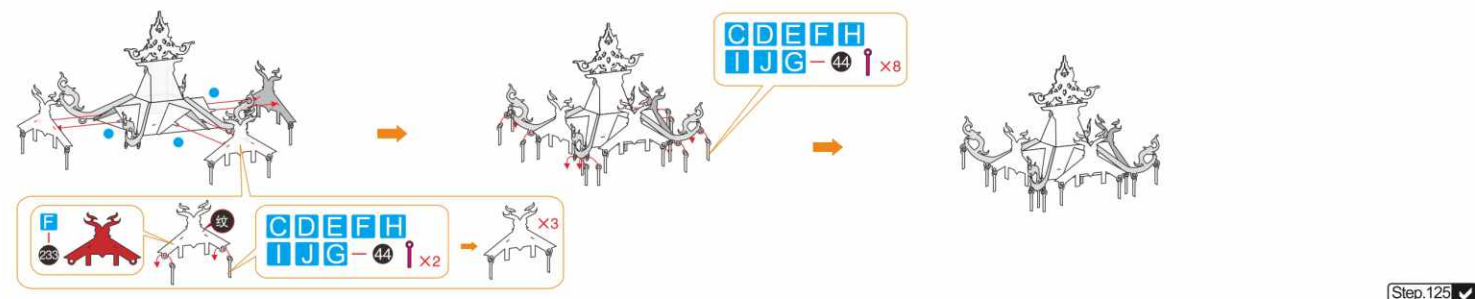

Step.125 ✓

Step 126



Step.126 ✓

Step 127

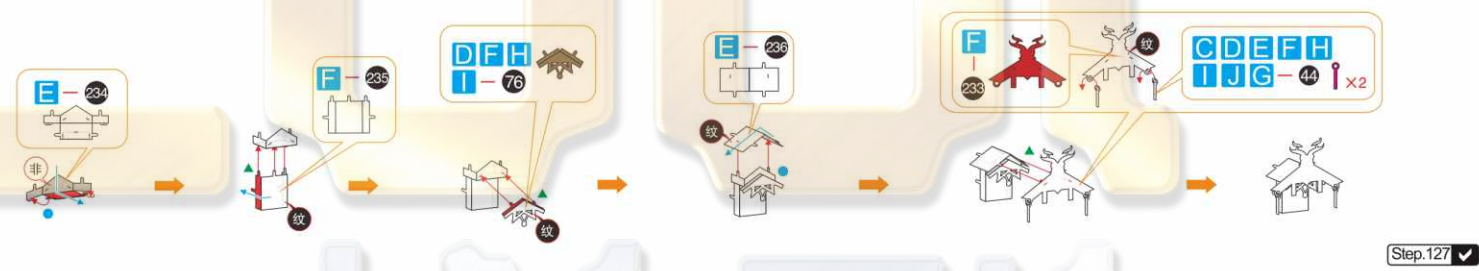

Step.127 ✓

Step 128

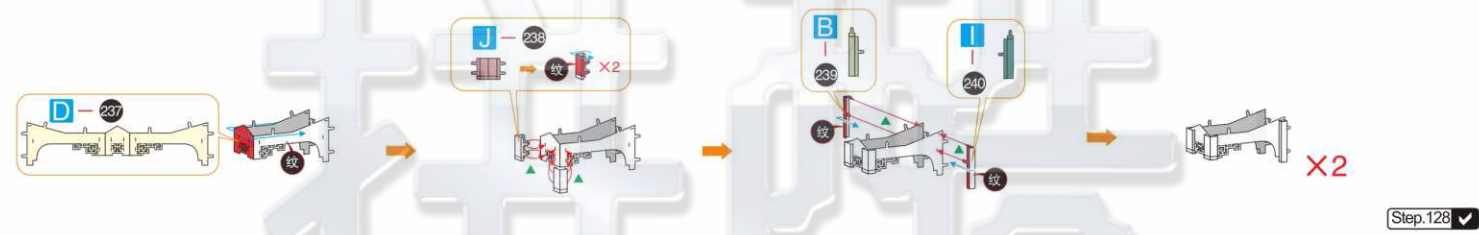

Step.128 ✓

Step 129

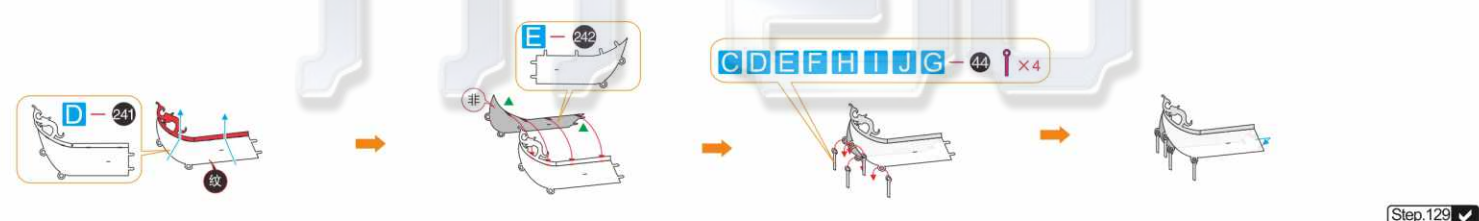

Step.129 ✓

Step 130

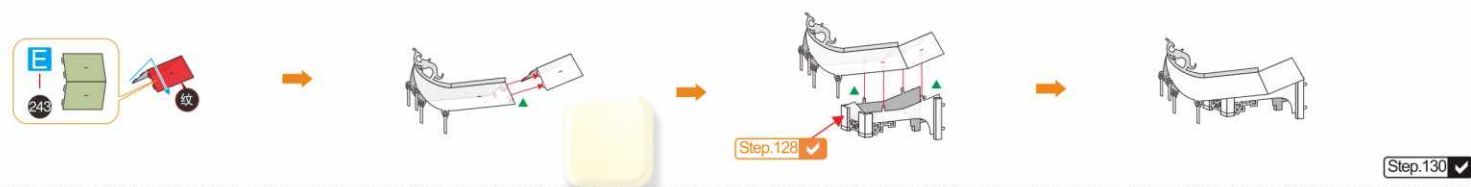

Step 131

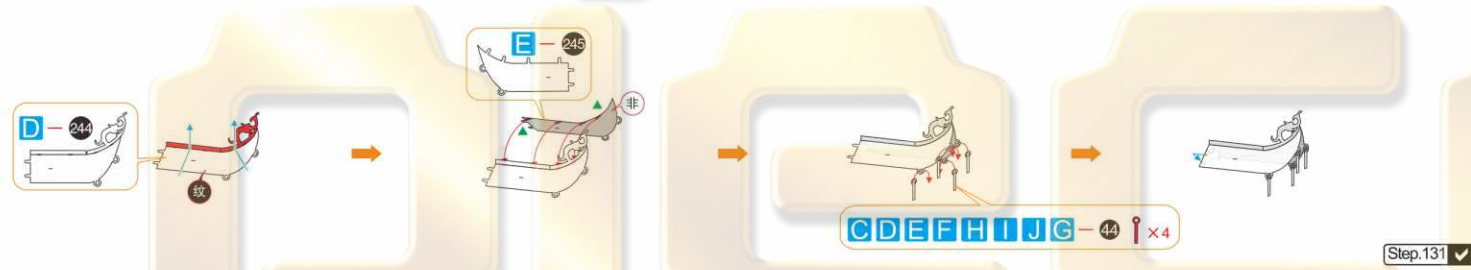

Step 132

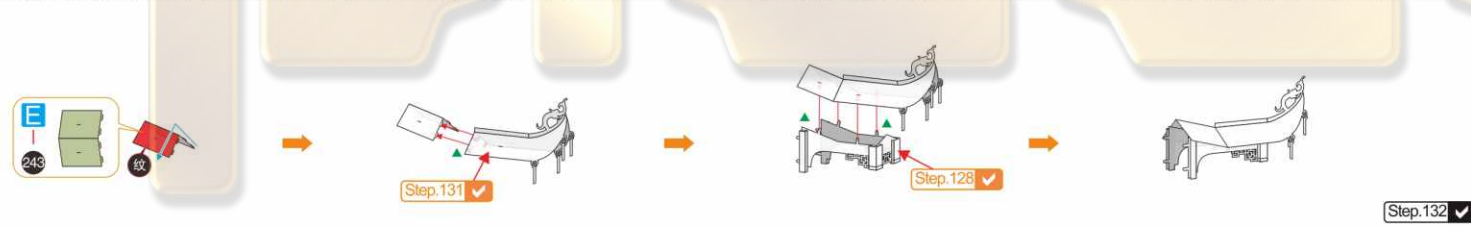

Step 133

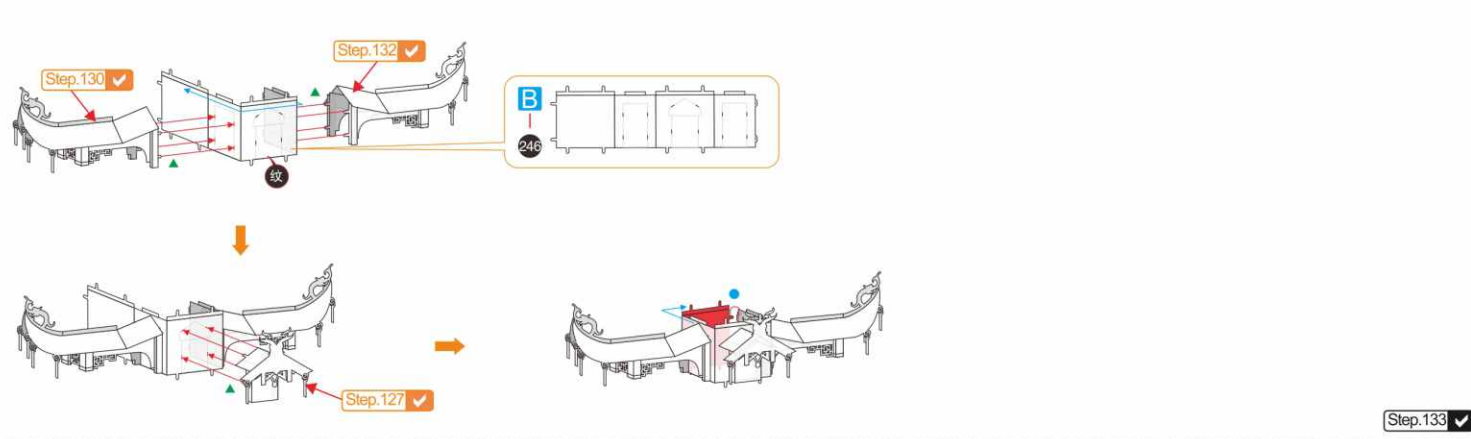

Step 134

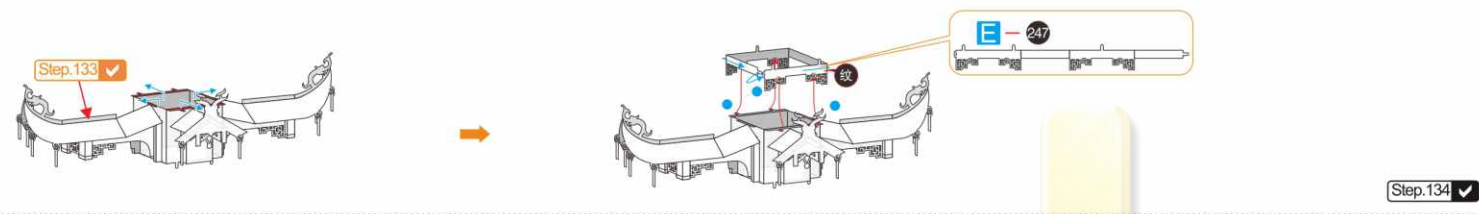

Step 135



Step 136

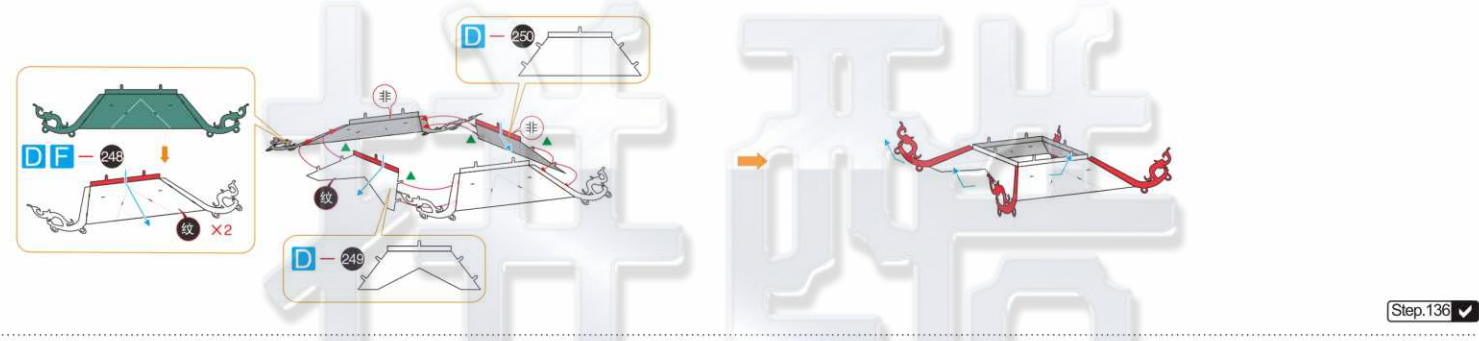

Step 137



Step 138

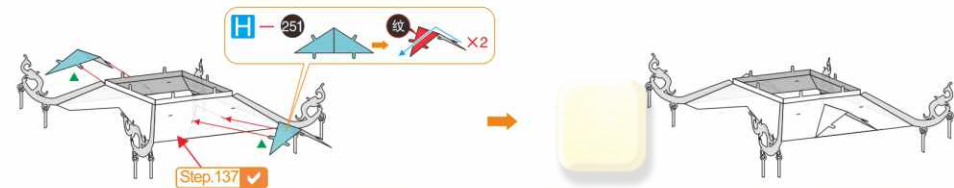

Step.138 ✓

Step 139

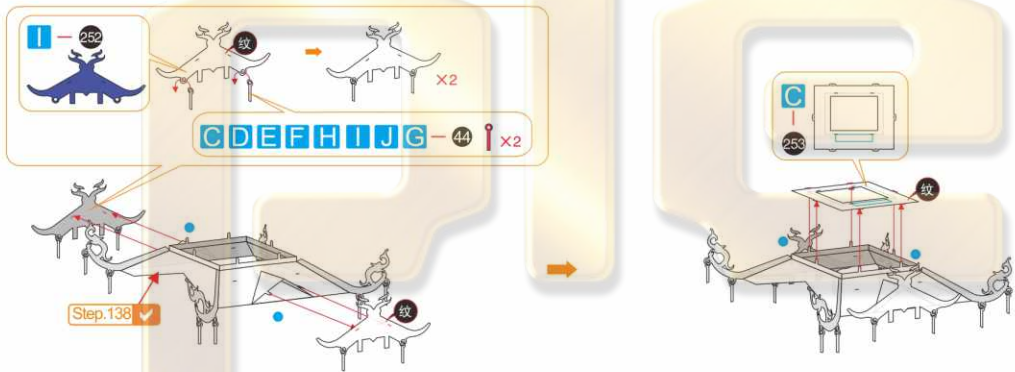

Step.139 ✓

Step 140

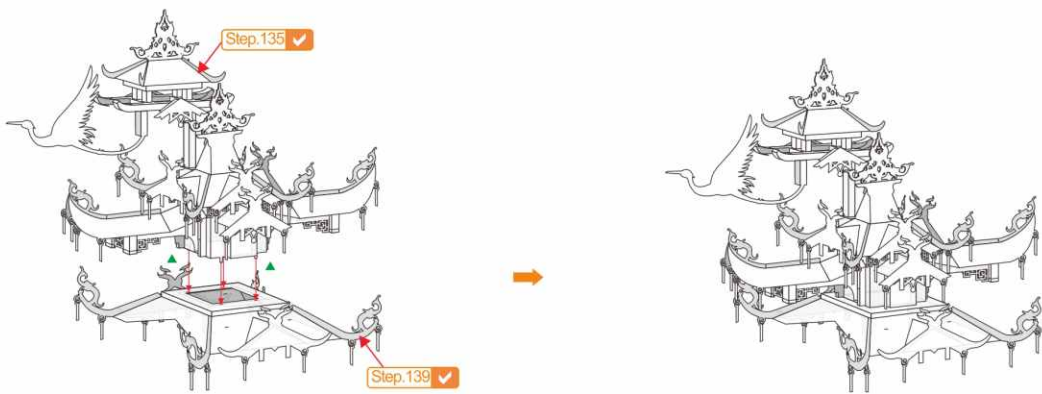

Step.140 ✓

Step 141

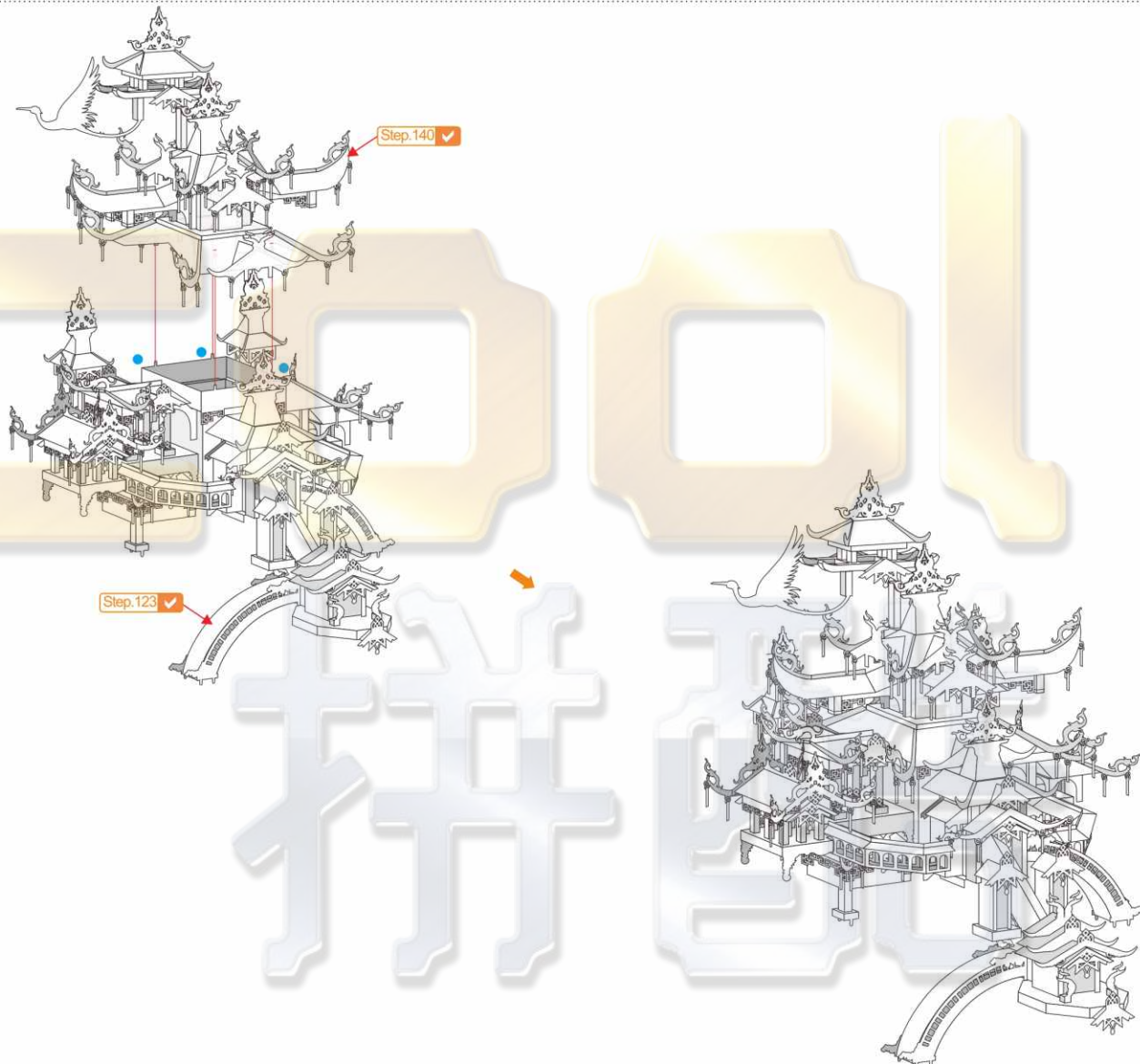

Step.141 ✓

Step 142

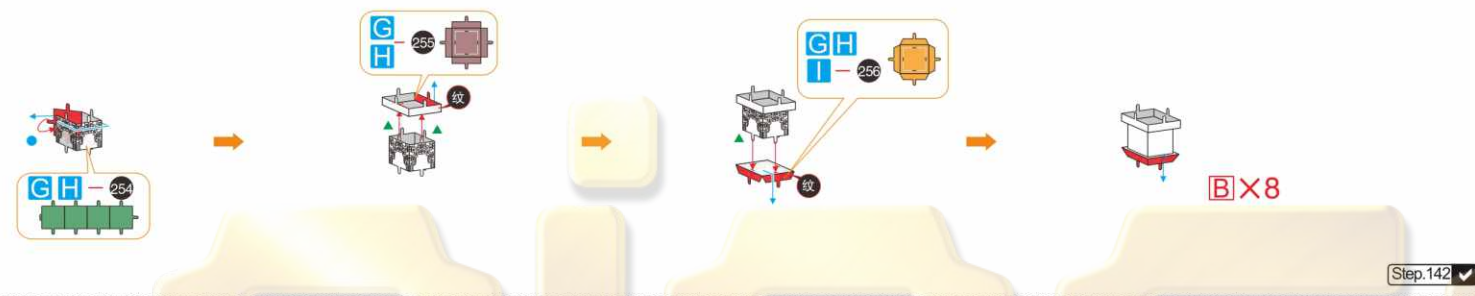

Step.142 ✓

Step 143



Step.143 ✓

Step 144

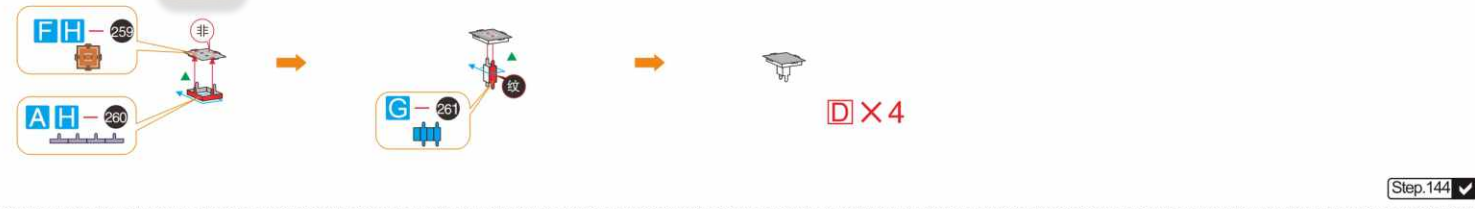

Step.144 ✓

Step 145

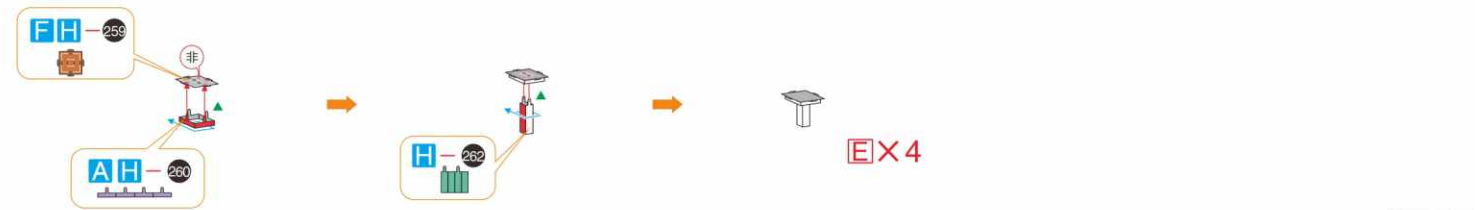

Step.145 ✓

Step 146

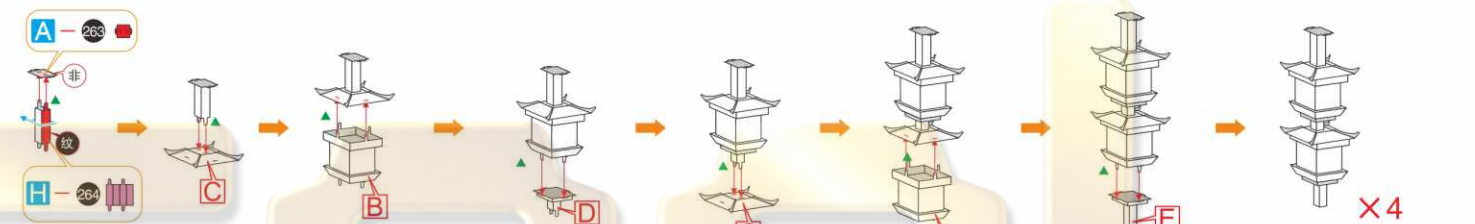

Step.146 ✓

Step 147

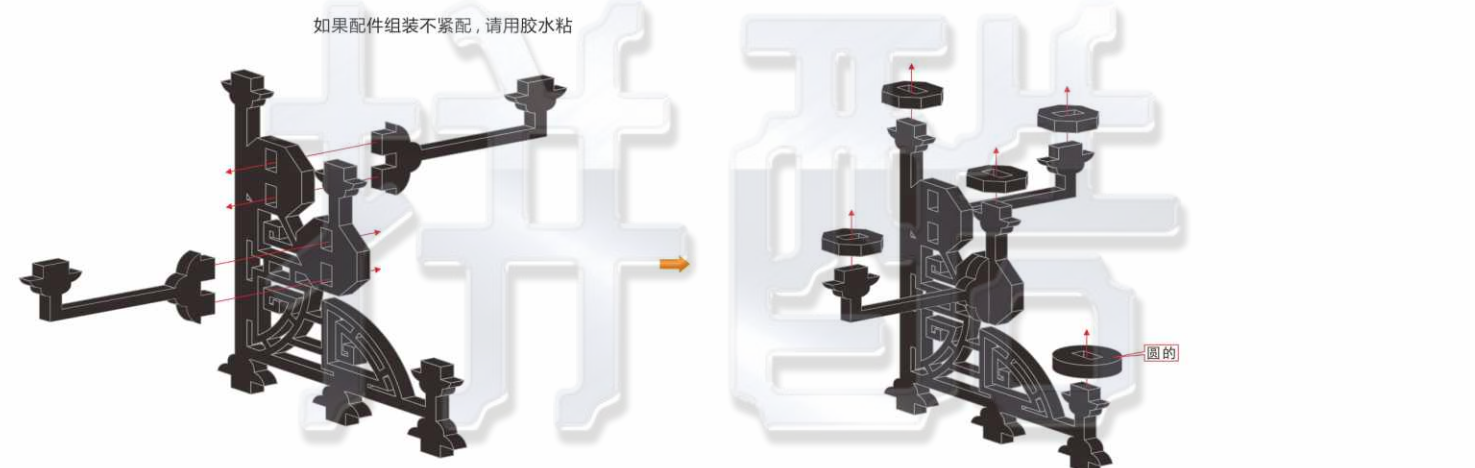

Step.147 ✓

Step
148

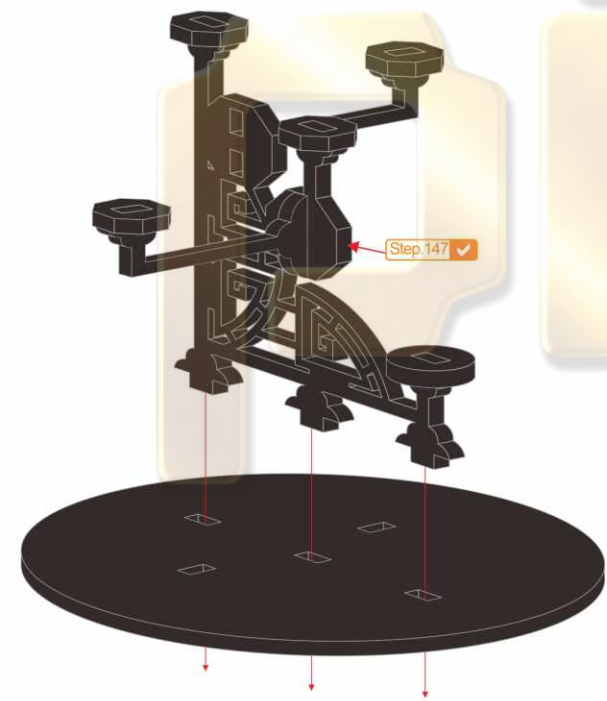

Step.148 ✓

Step
149



Step.149 ✓

Step
150

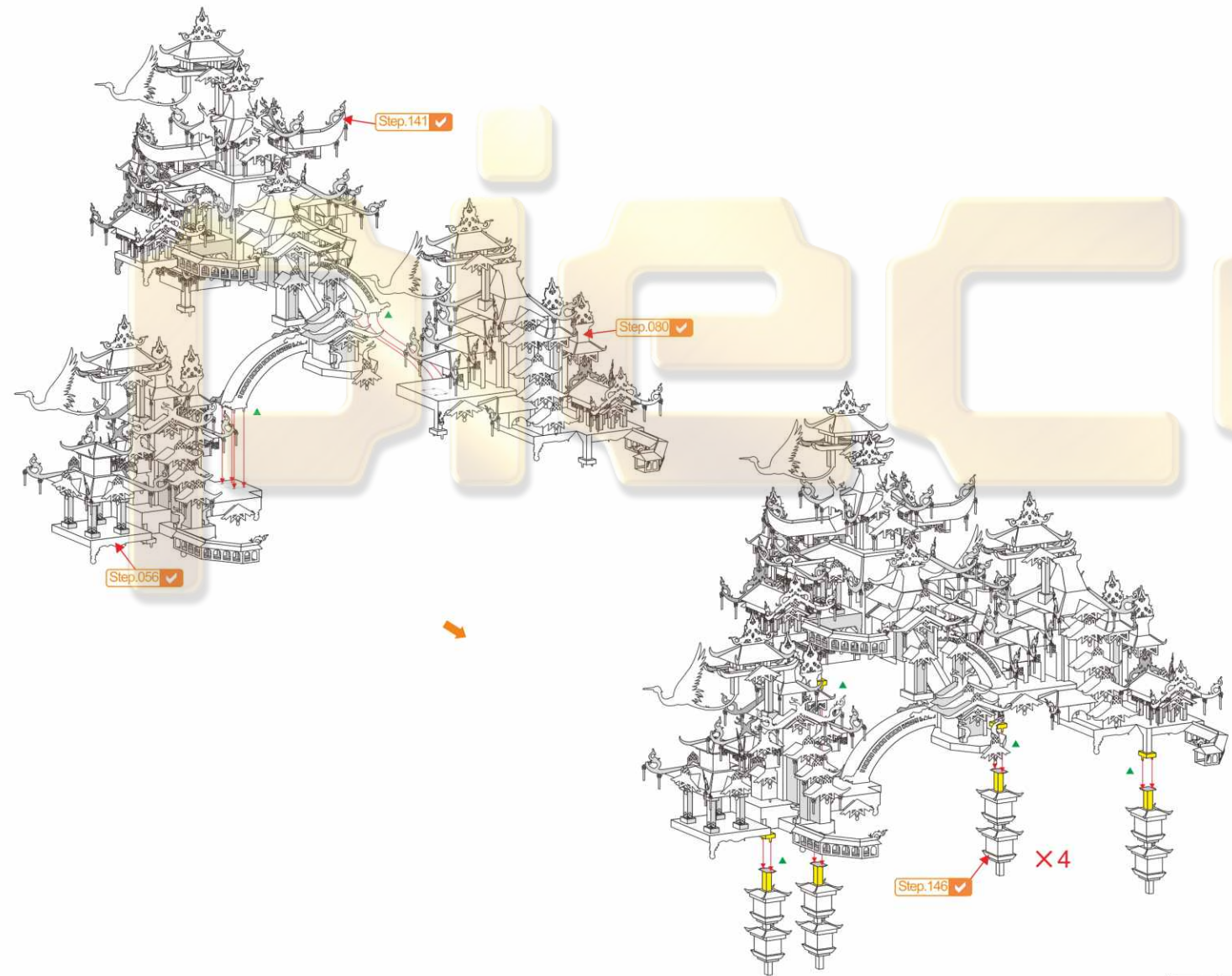

Step.150 ✓

Step
151

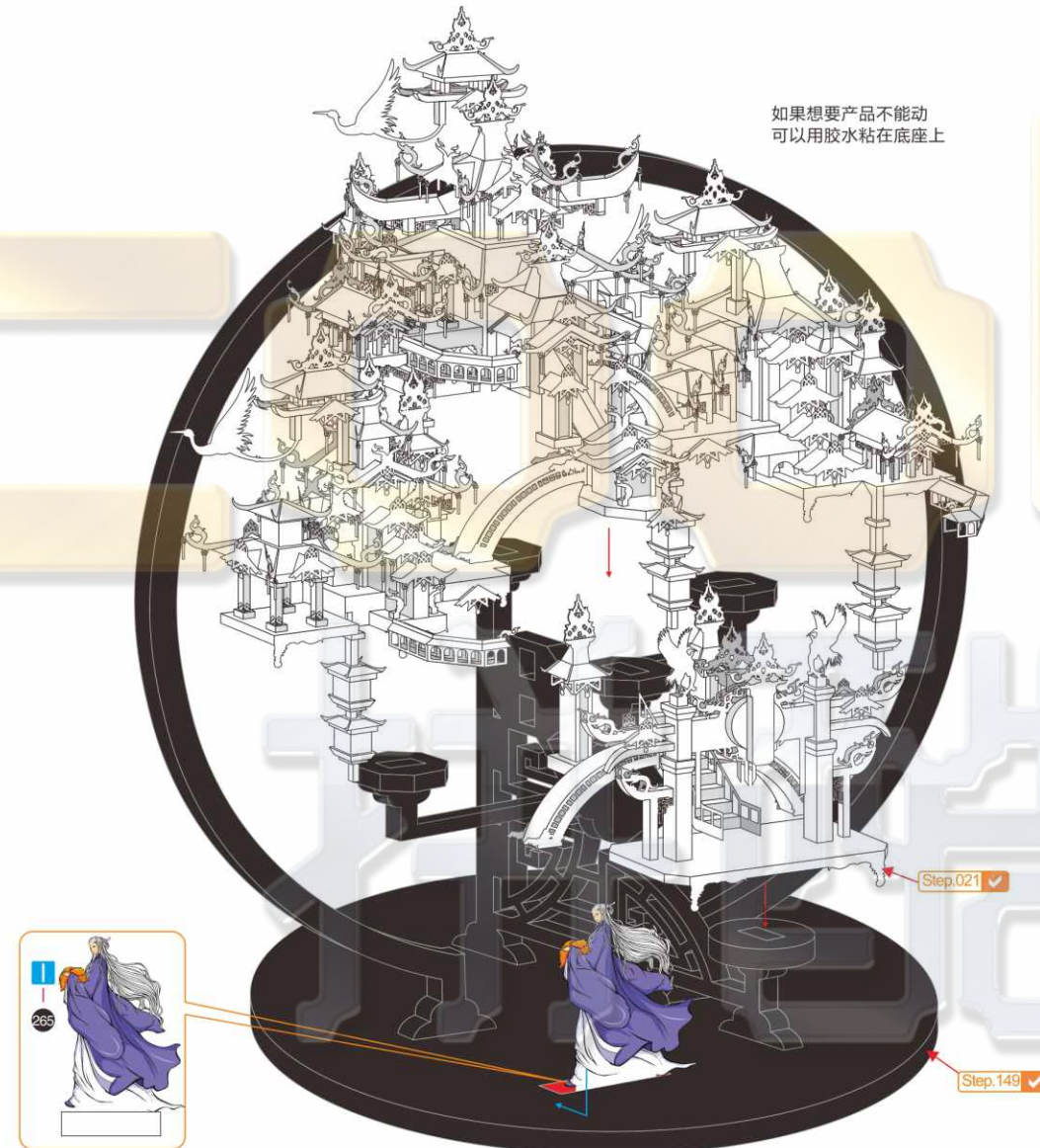

Step.151 ✓



拼装酷

更多产品信息, 请浏览www.Piececool.com官方网站

东莞市微石塑胶金属科技有限公司 出品
WIST PLASTIC & METAL TECHNOLOGY LIMITED
地址：广东省东莞市寮步镇向西工业区村口街2号 邮编：523408
电子邮箱：kf@wist-group.com
服务热线：0769-8119 2243

© Wist Plastic & Metal Technology Limited. All rights reserved.

CP-ASSY-P169-A1-20201116