

紫微宫  
ZIWEI PALACE  
P158

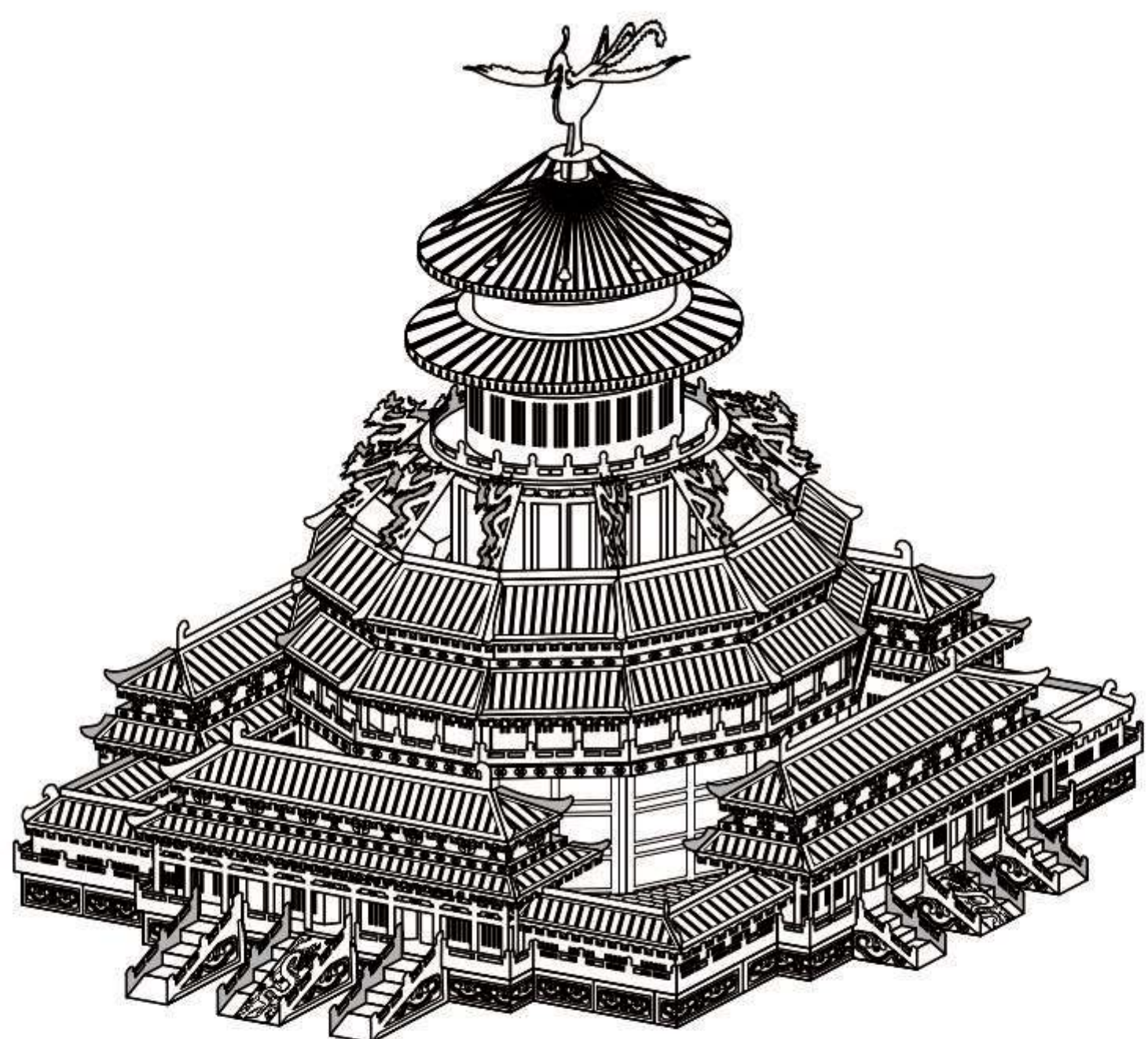

CP-ASSY-P158#-A1-20200617

拼前需知

● 准备工具：

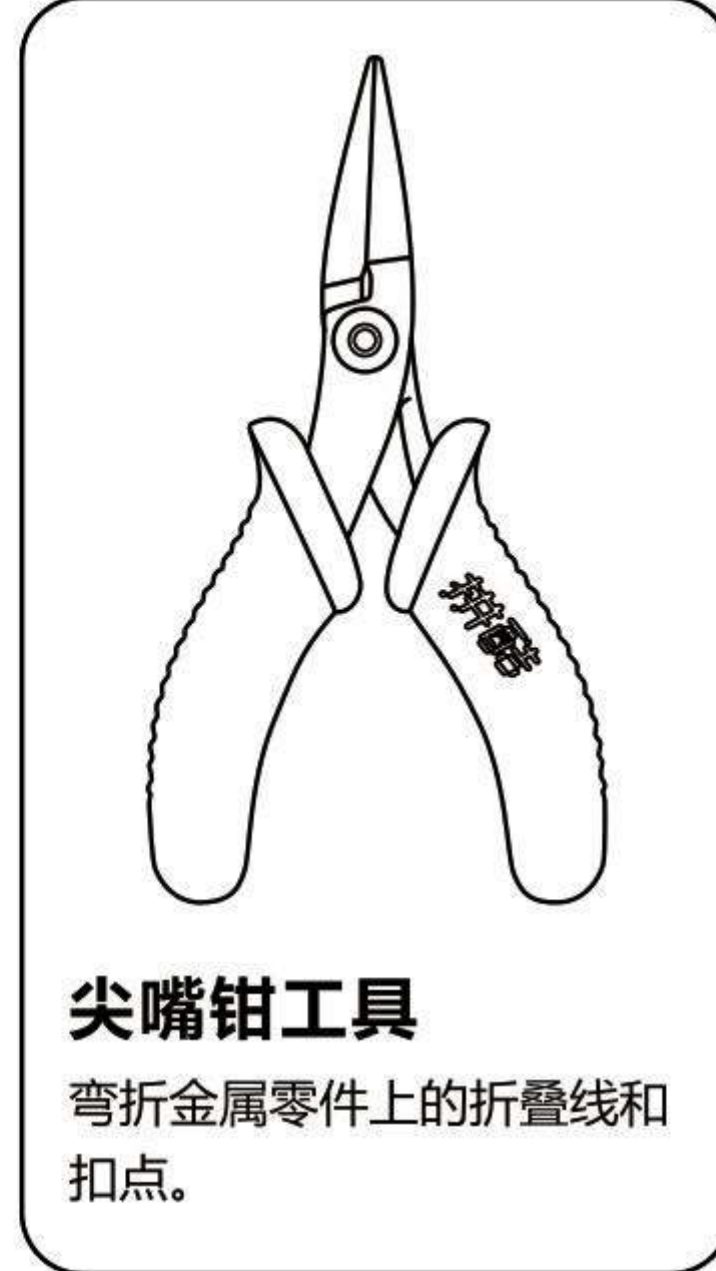
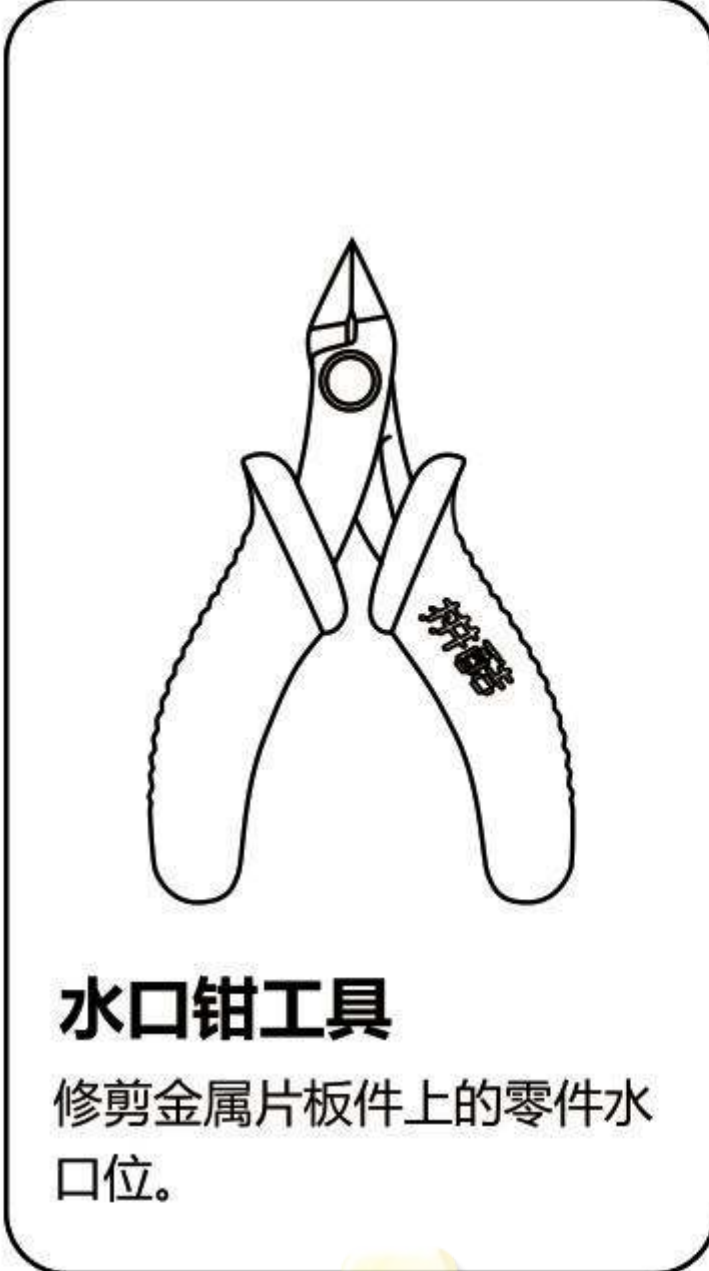

建议使用拼酷正品拼装工具（水口钳、尖嘴钳），拼装时更省心、省力，拼装后作品更精细、美观！

⚠️ 请小心处理金属边料，以防划伤

● 拼装方法：

a. 取下零件



使用水口钳剪断金属零件上的水口，将需要的金属零件从金属片板件取下。

b. 识别零件

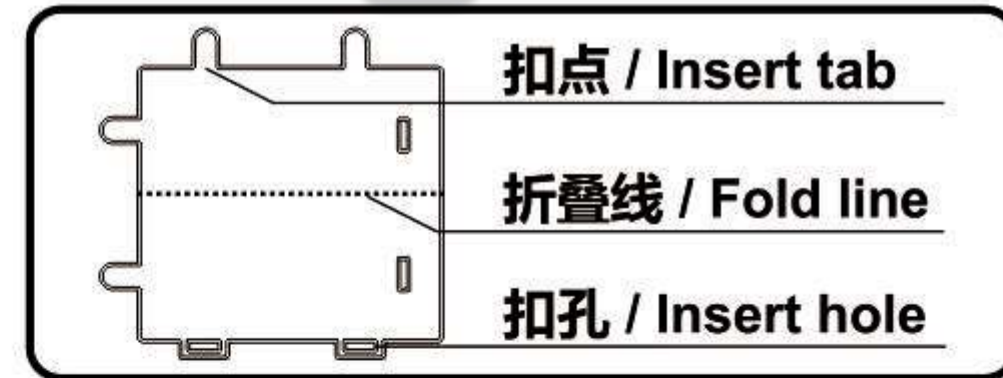

识别金属零件上的扣点、折叠线、扣孔的样子。

c. 折叠零件

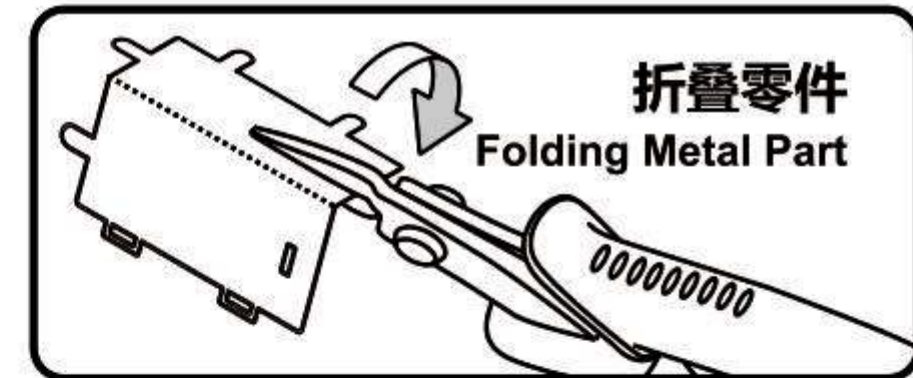

使用尖嘴钳，参照拼装说明书将金属零件折成形状。

d. 固定零件



● 插入扣孔，平折 90°



● 插入扣孔，旋转 90°

● 注意事项：



剪金属零件时请剪零件“水口位”，请勿将“扣点”当成“水口位”剪下，每次剪零件时请仅剪当前步骤的零件，切勿一次性将所有零件全部剪下，避免丢失；  
当遇到折叠线的零件，请注意金属片的正反面及拼折方向，请按照说明书说明的方向，轻剪慢折，最好一次折叠完成，请勿反复折叠，避免零件损坏。

拼装步骤

Step 01

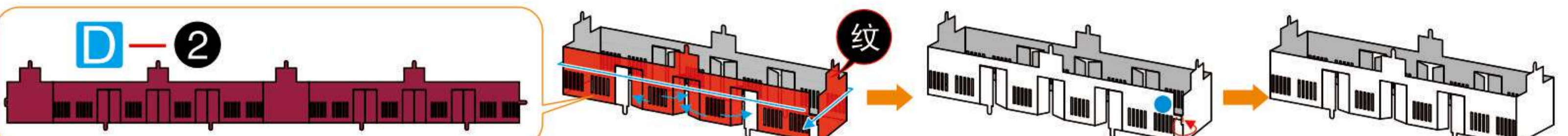
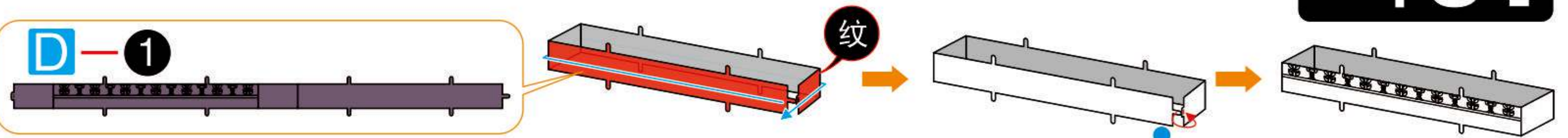

Step 02

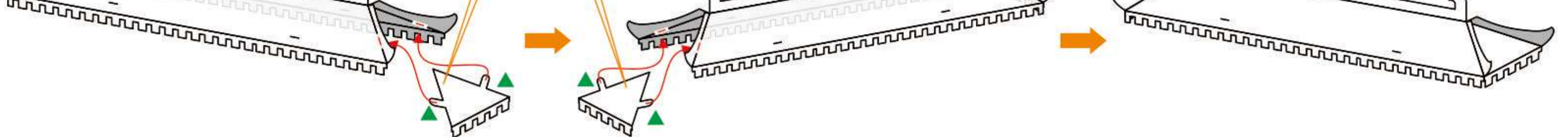
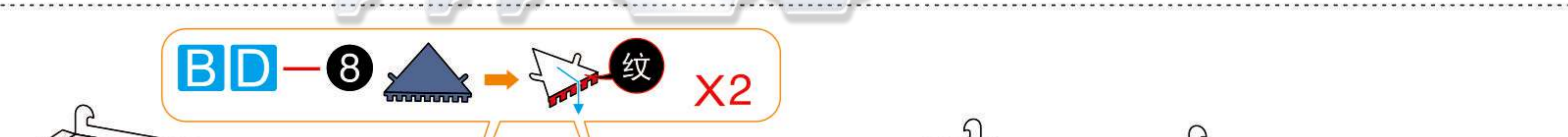
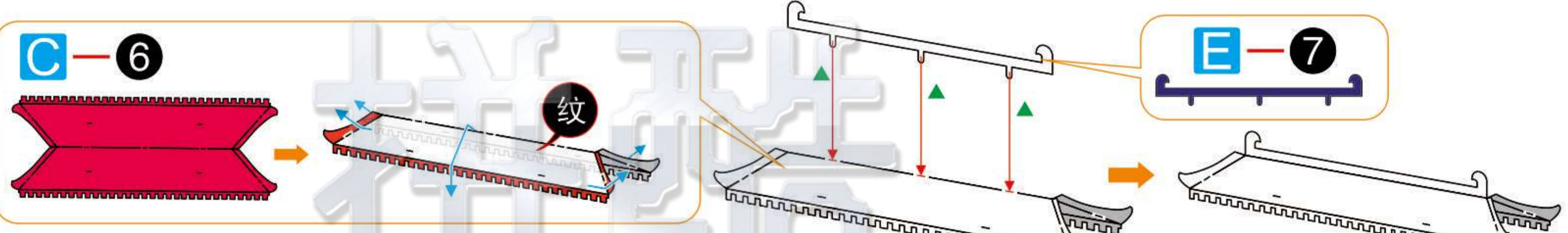
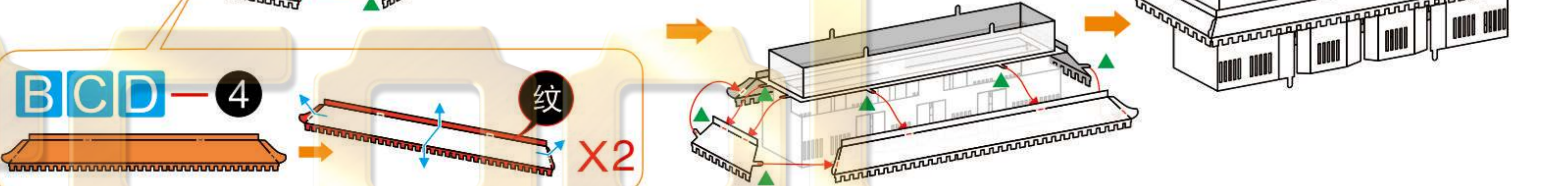
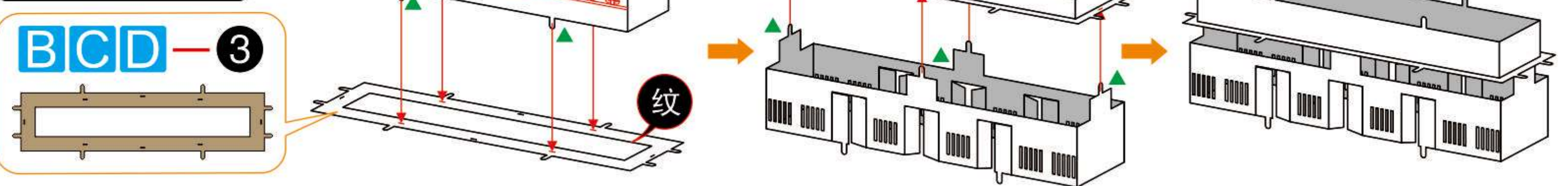

Step 03

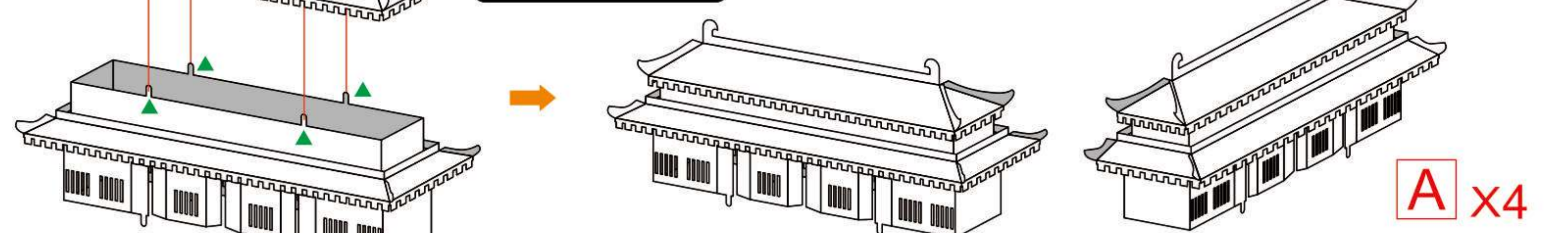

1 2  
3 4

Step 04

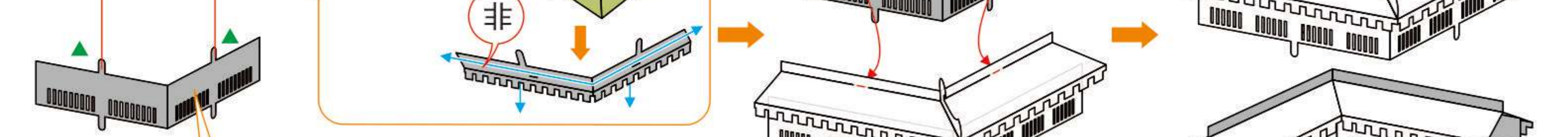
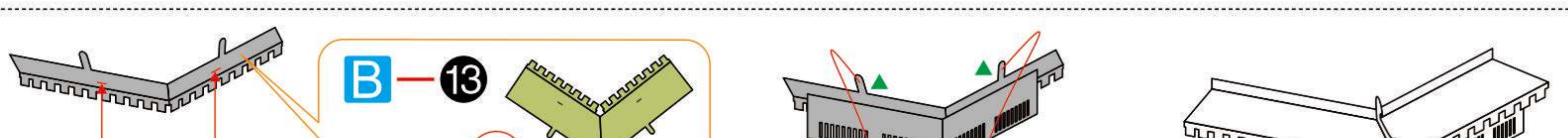
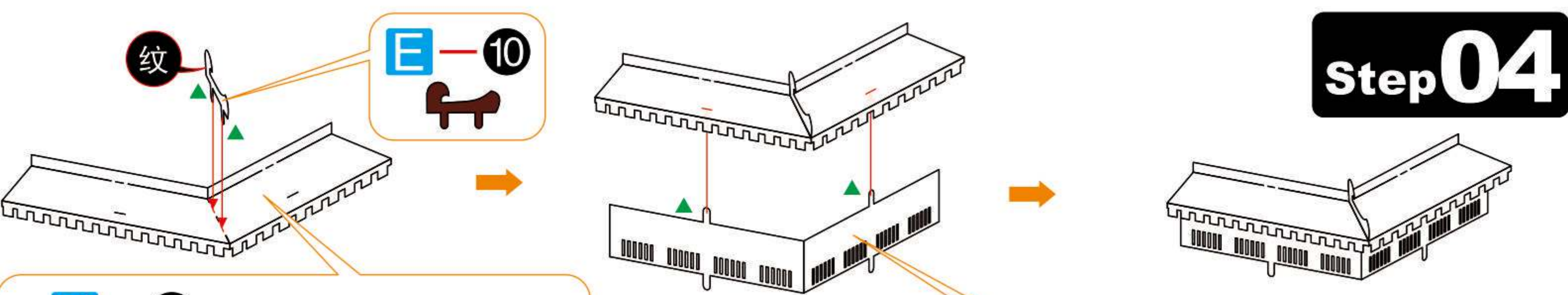

B x4

Step 05

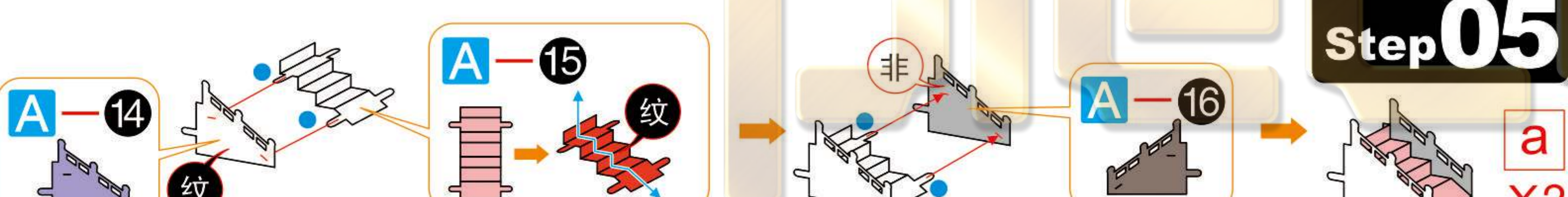

a x2

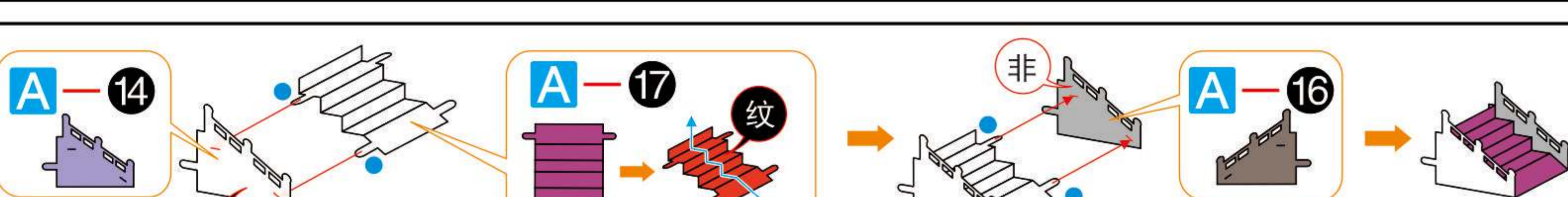

X4

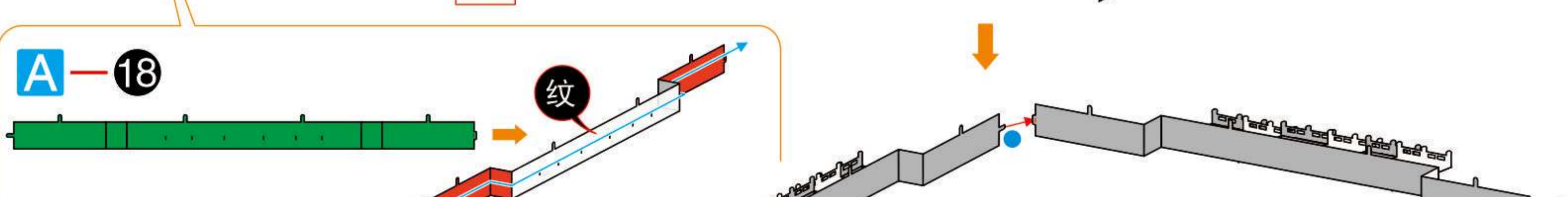

Step 06

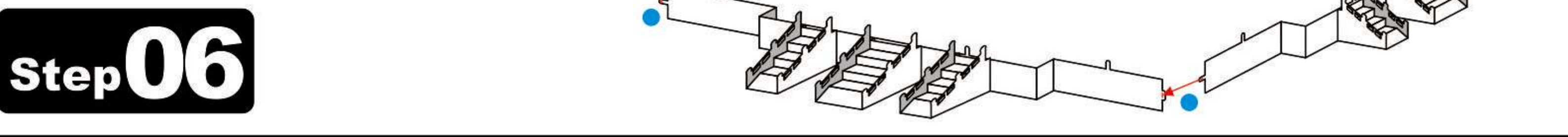

Step 07

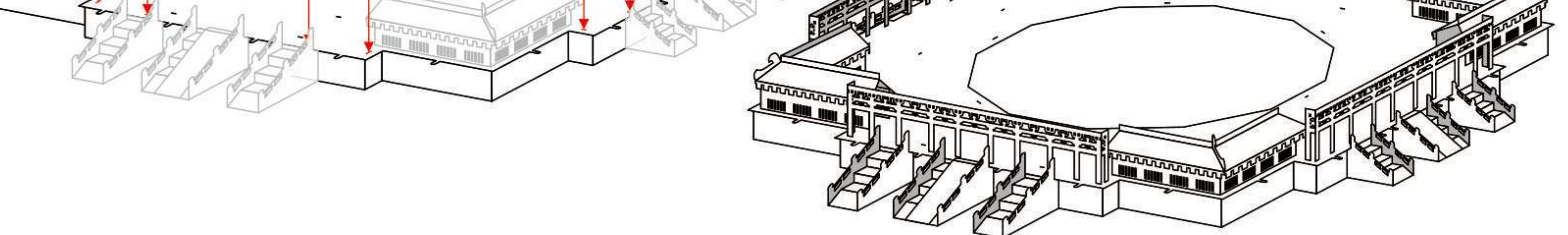
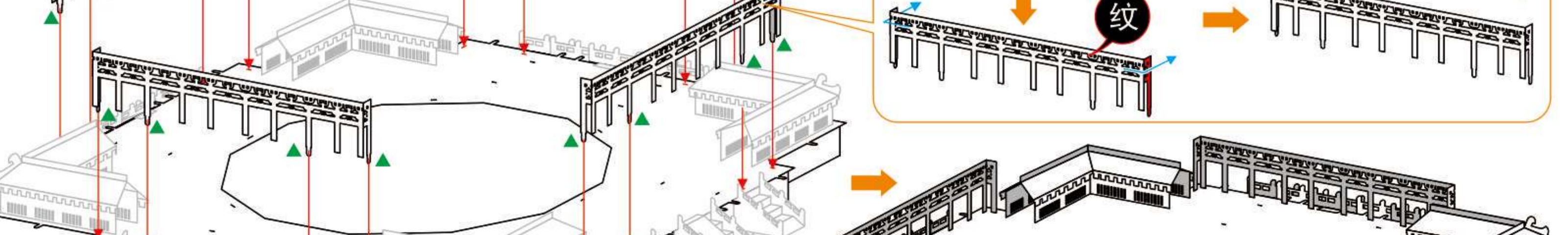
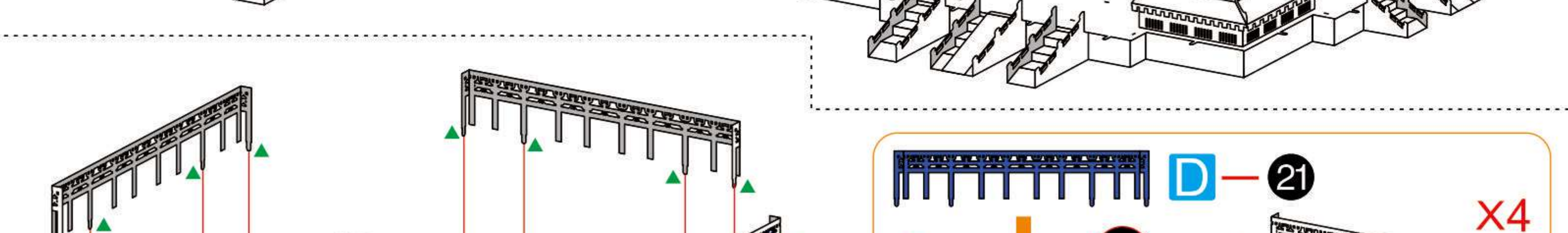
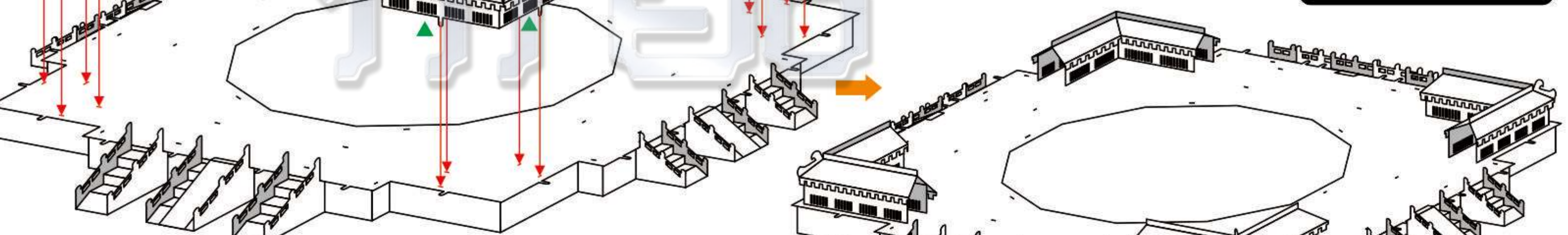

X4

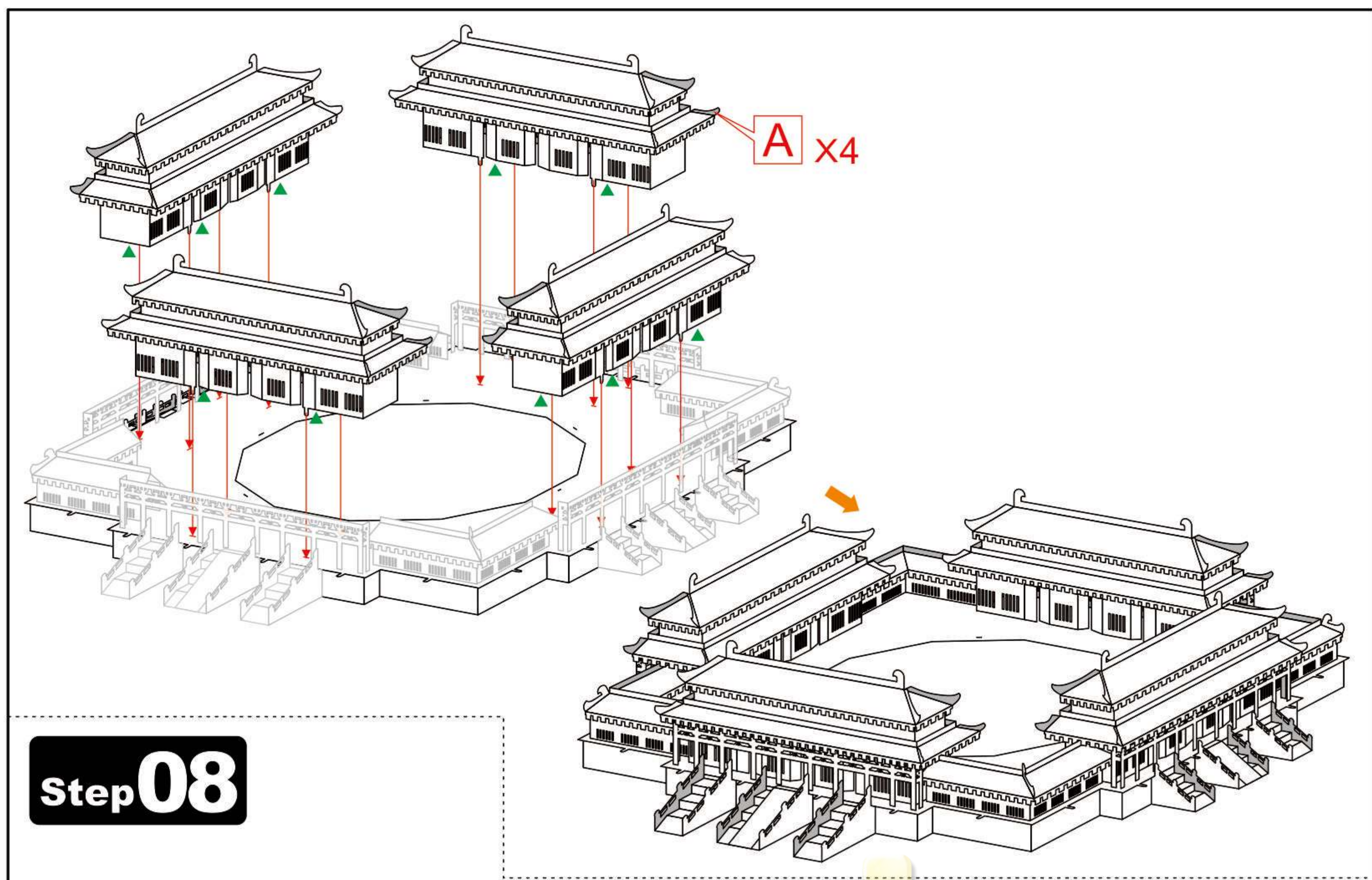

**Step 08**

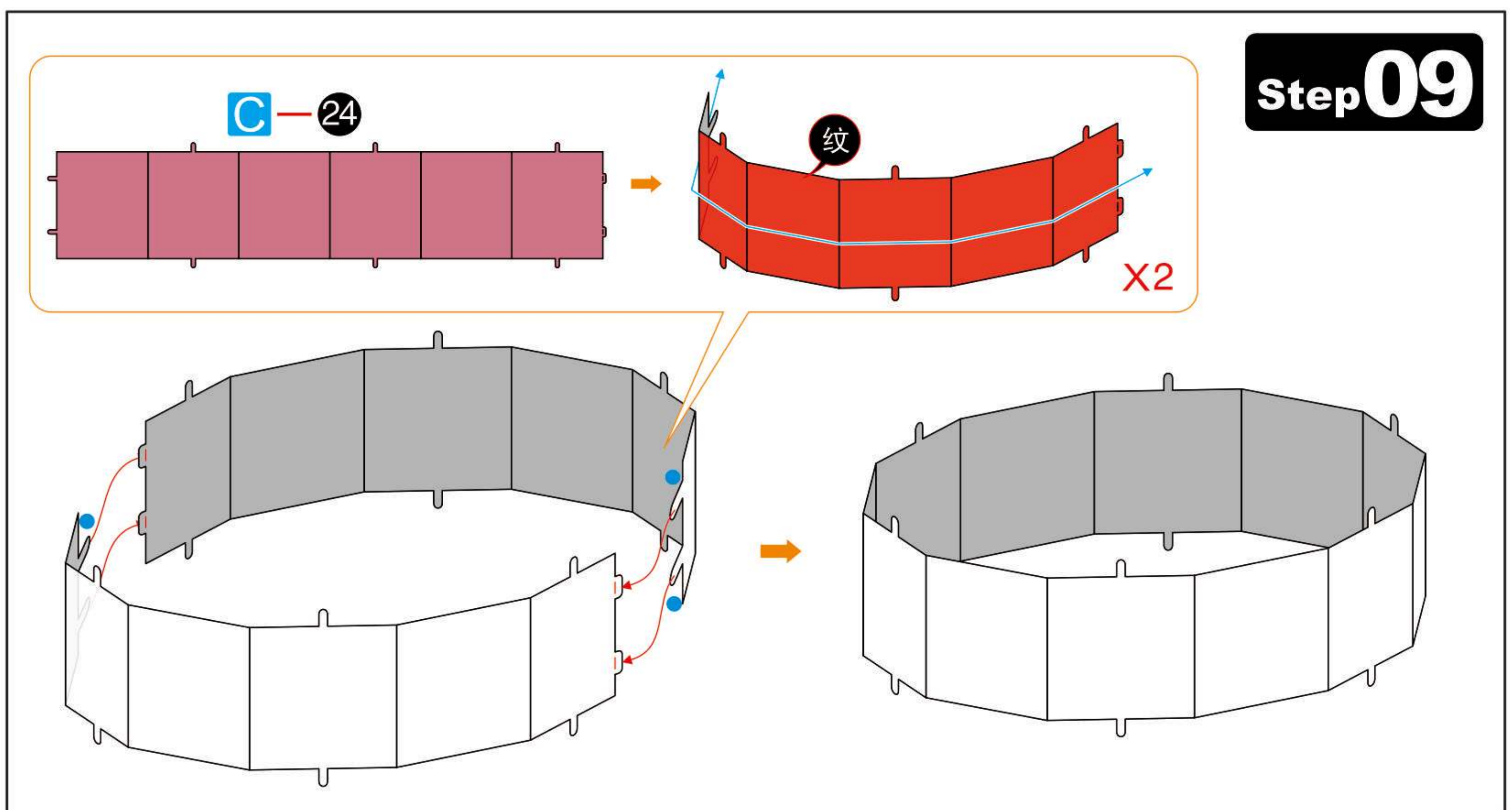
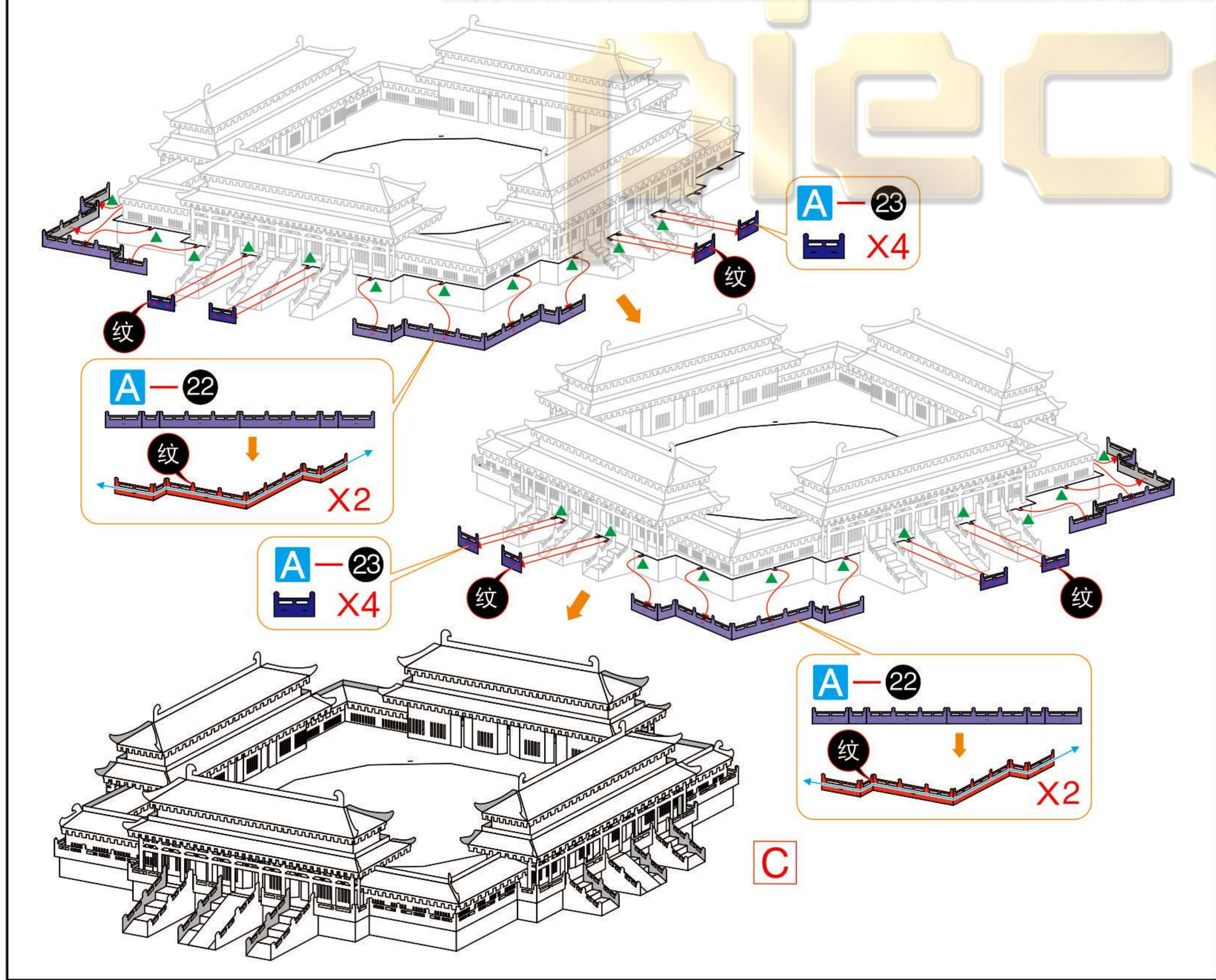

**Step 09**

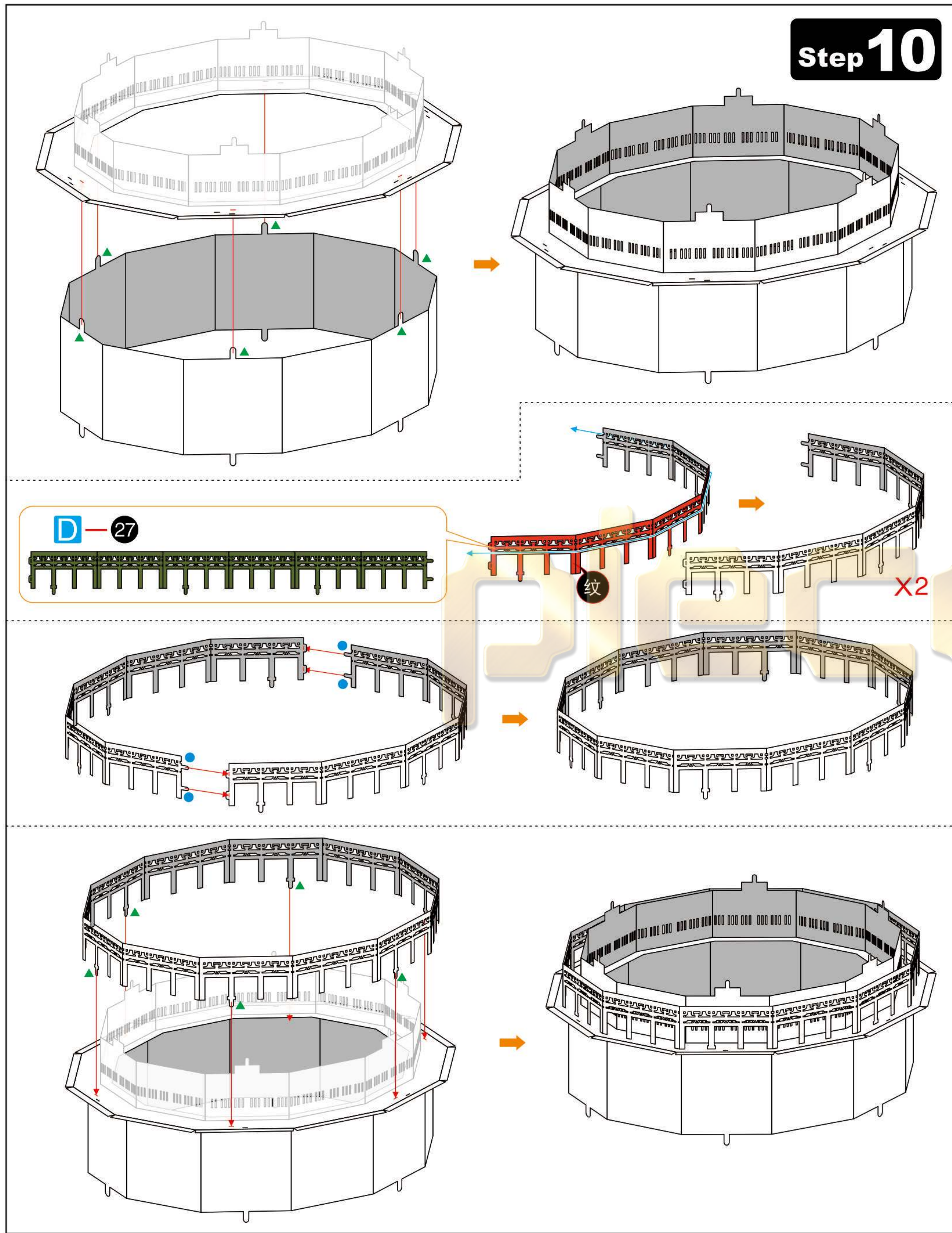
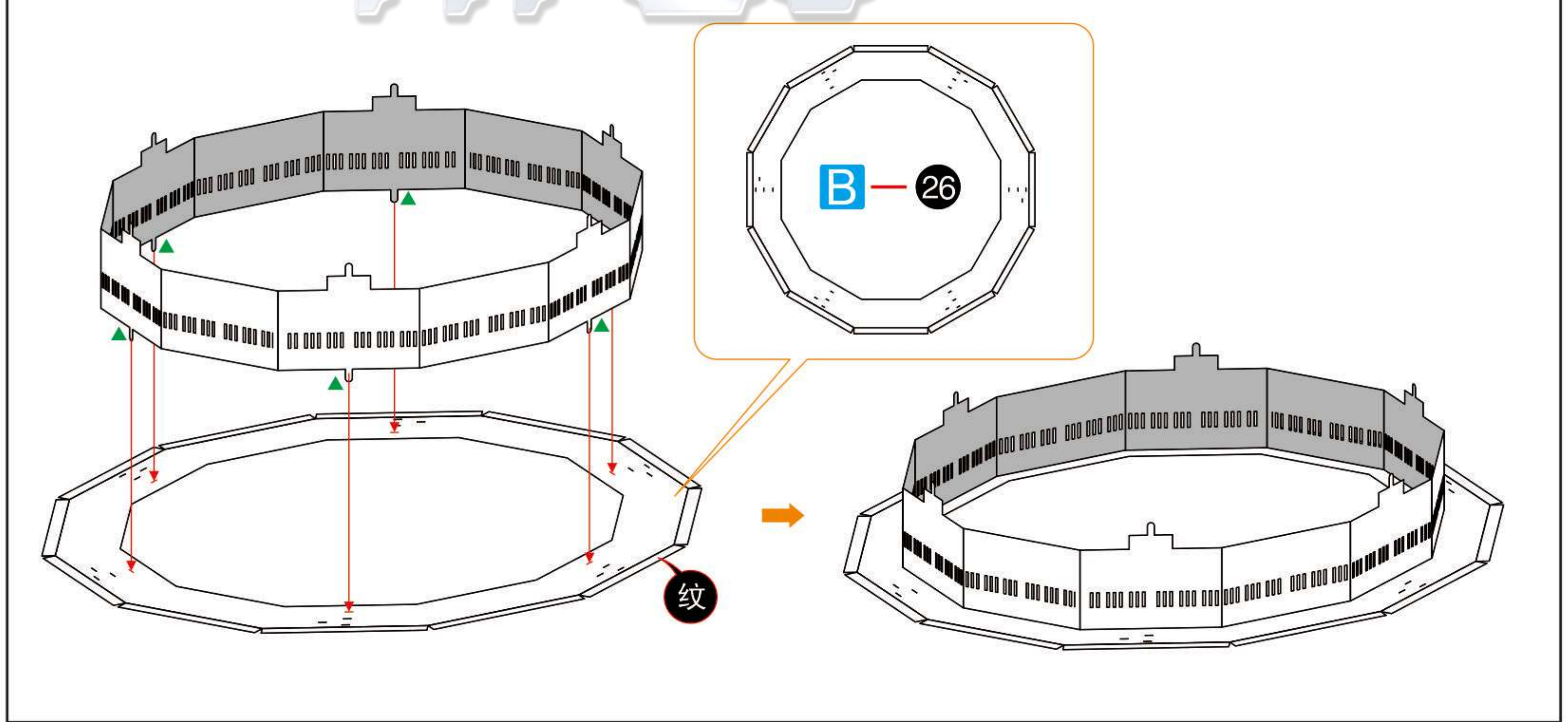
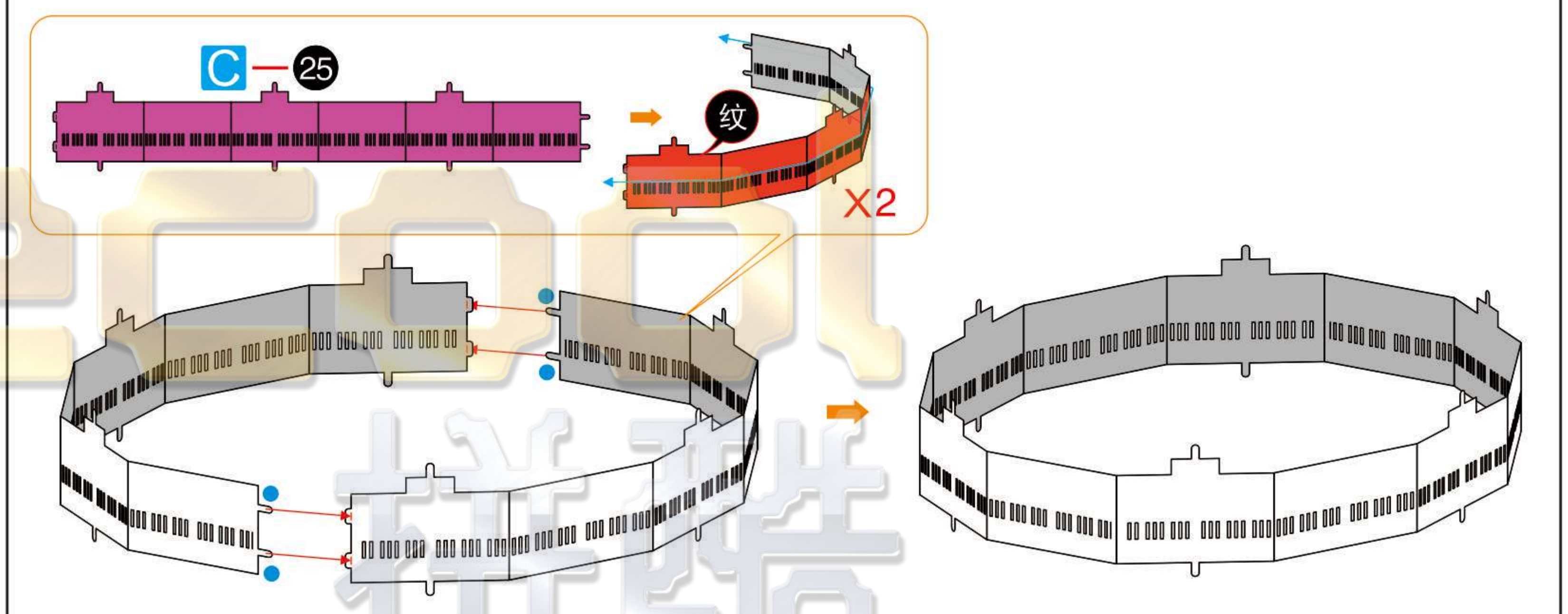

**Step 10**

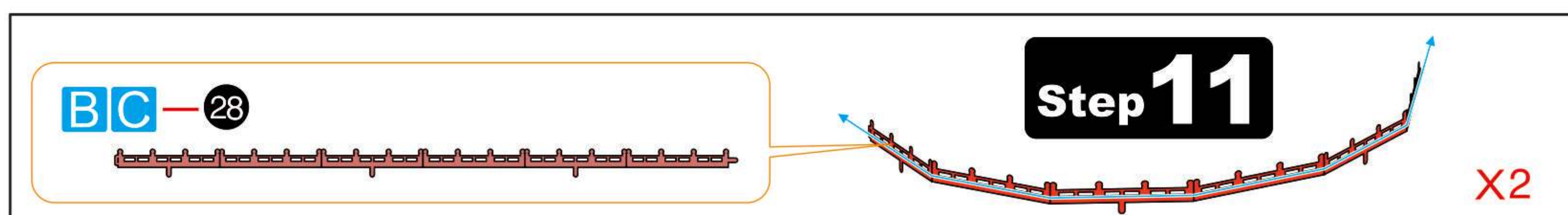

**Step 11**

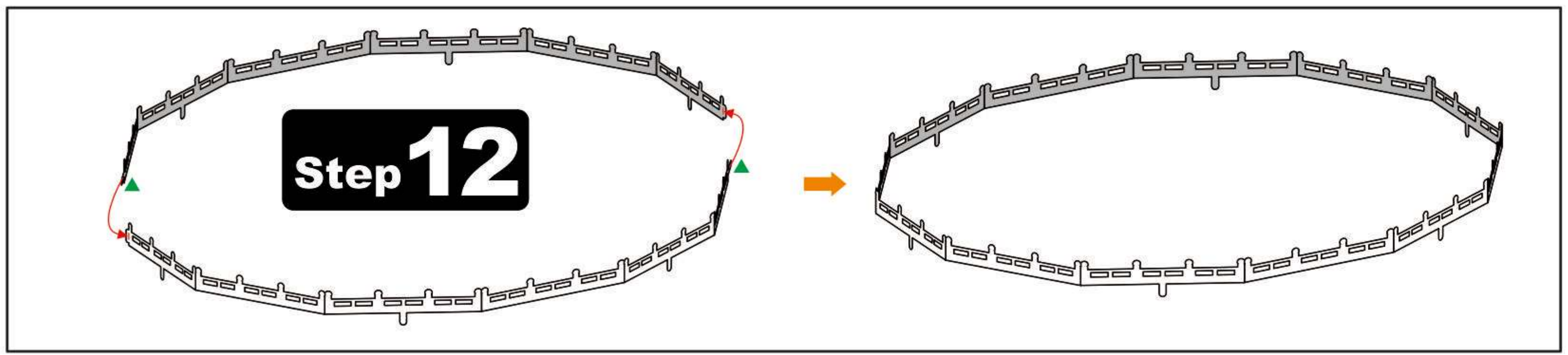

**Step 12**

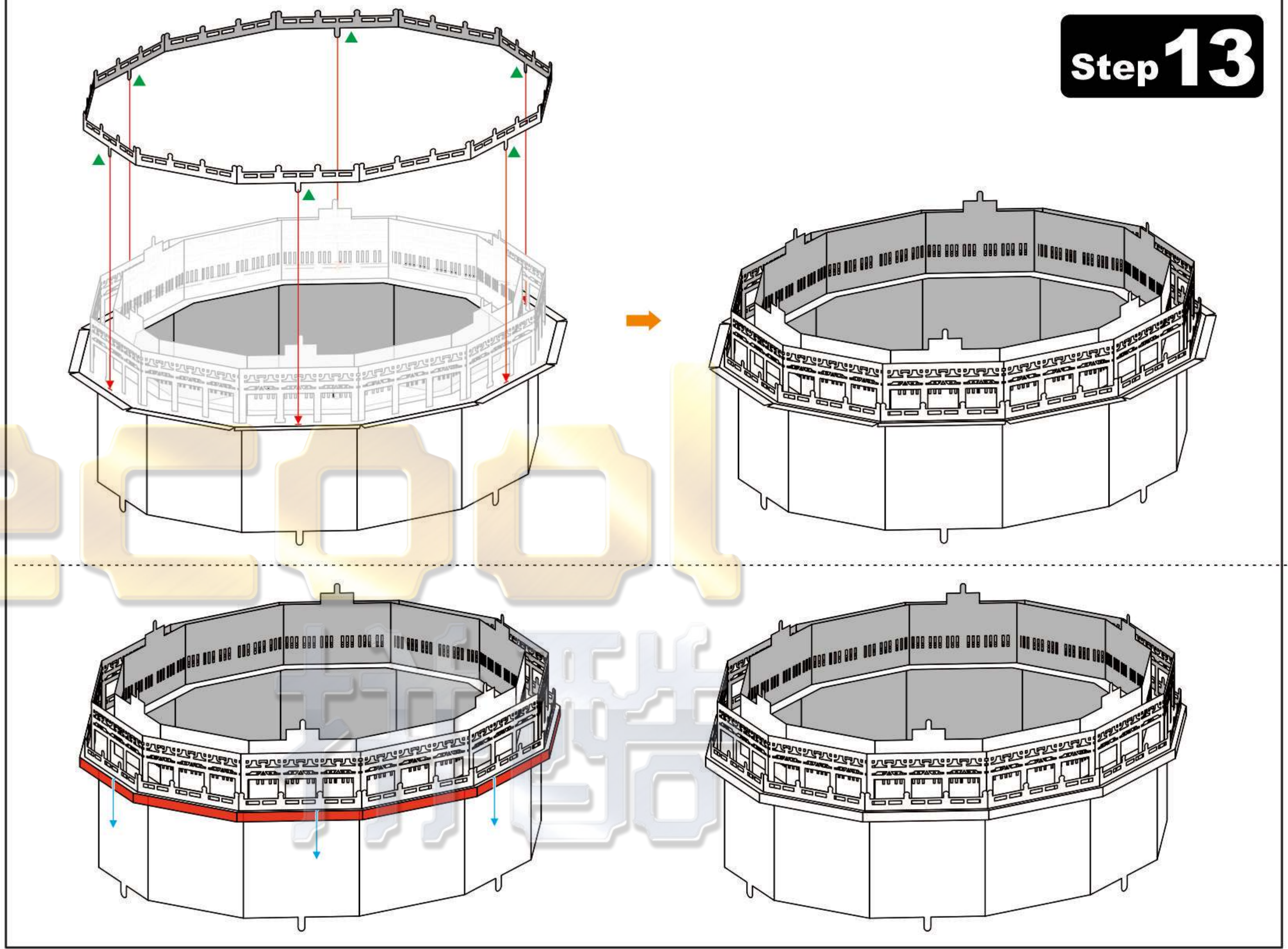

**Step 13**

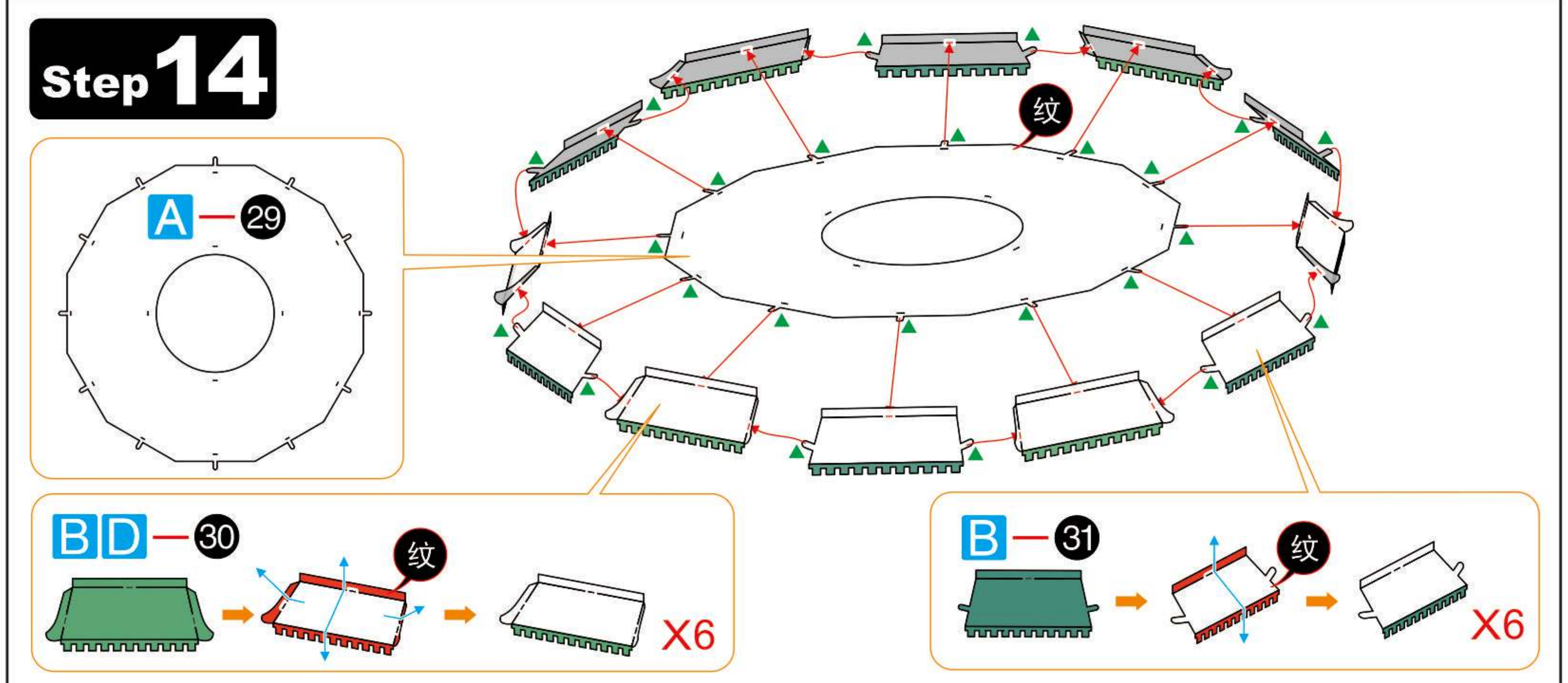

**Step 14**

Step 15

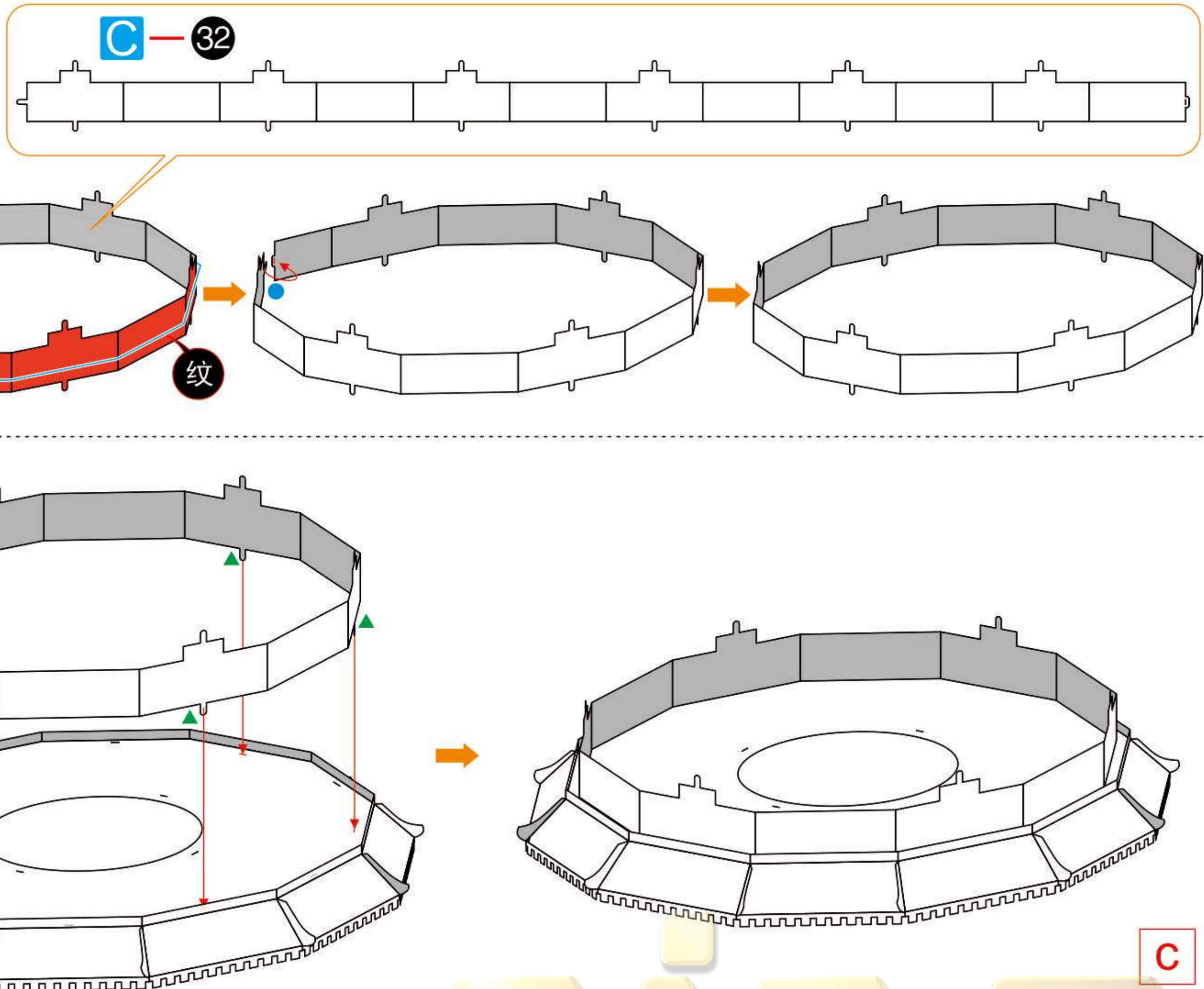

Step 18

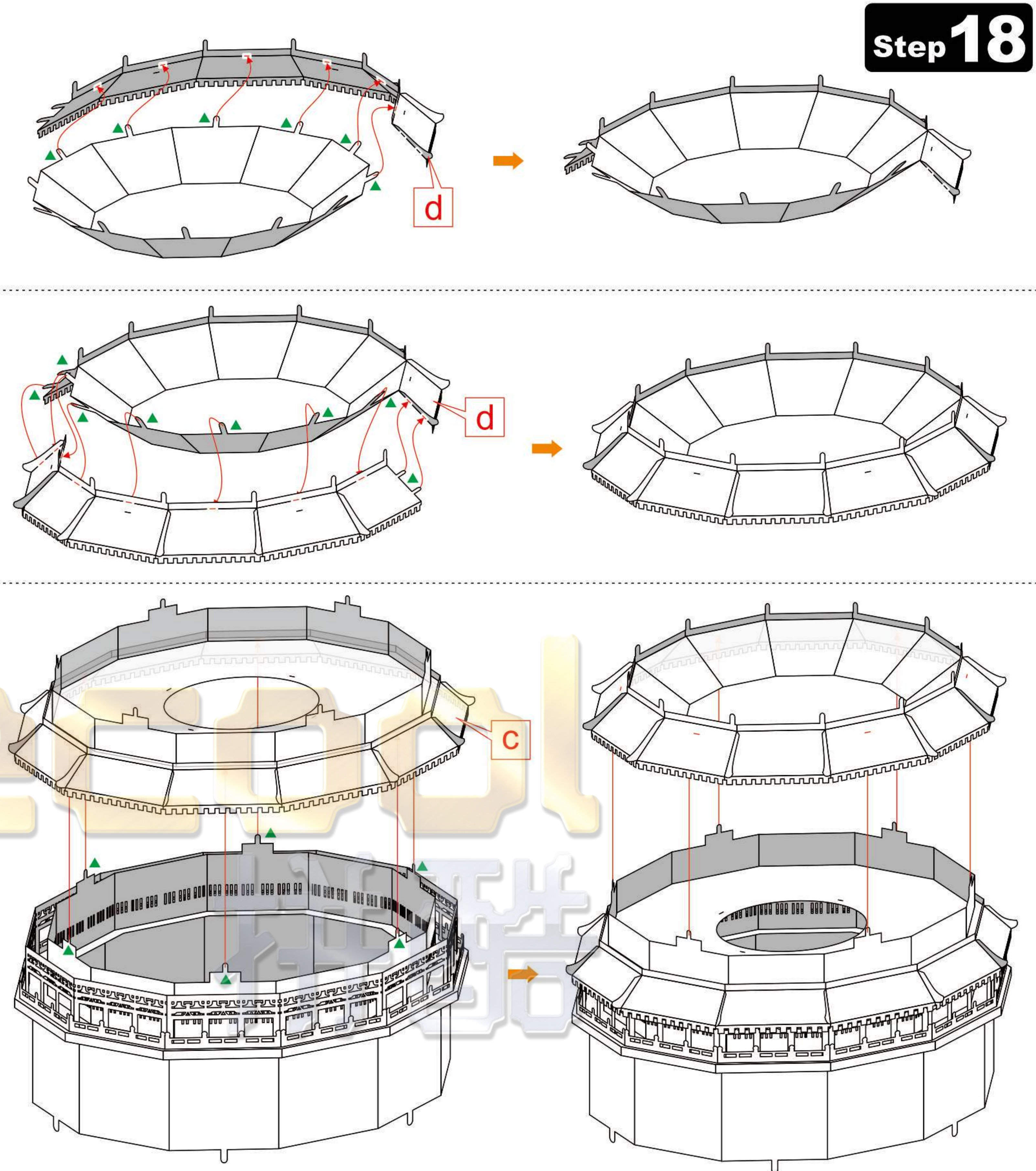

Step 16

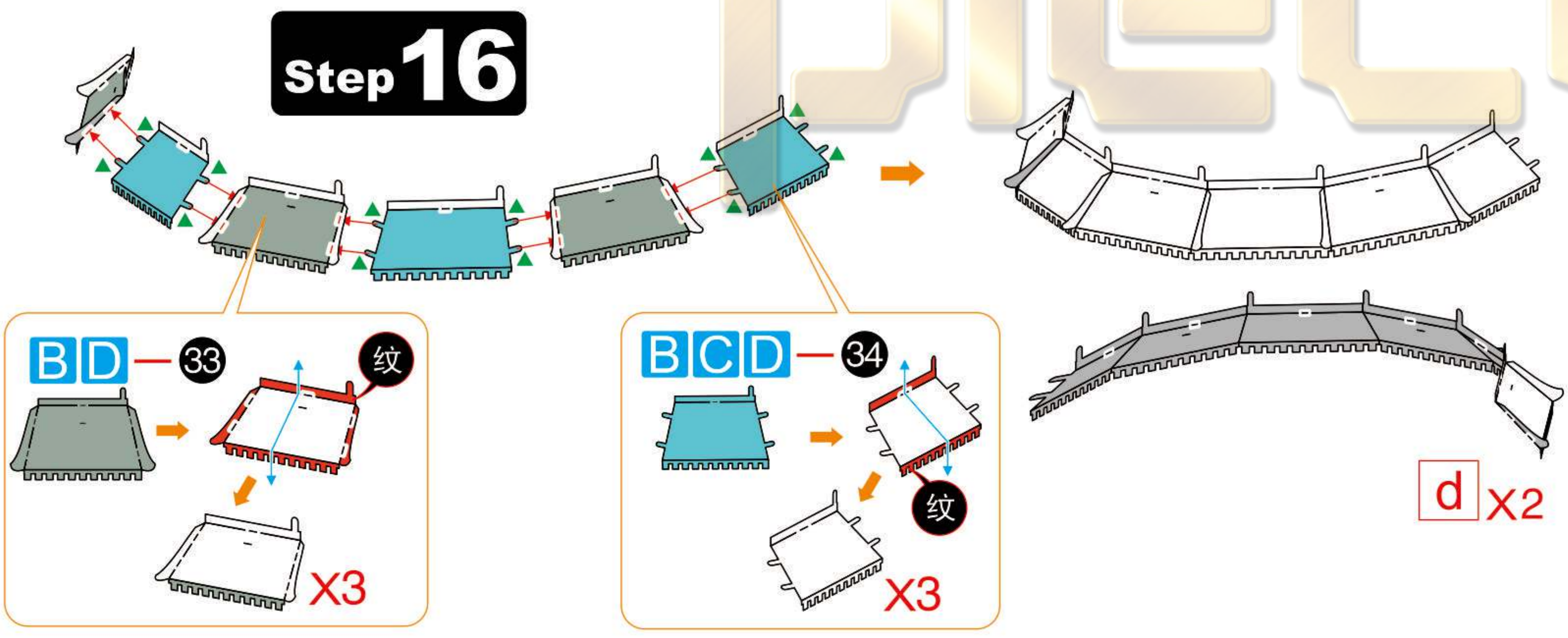

Step 17

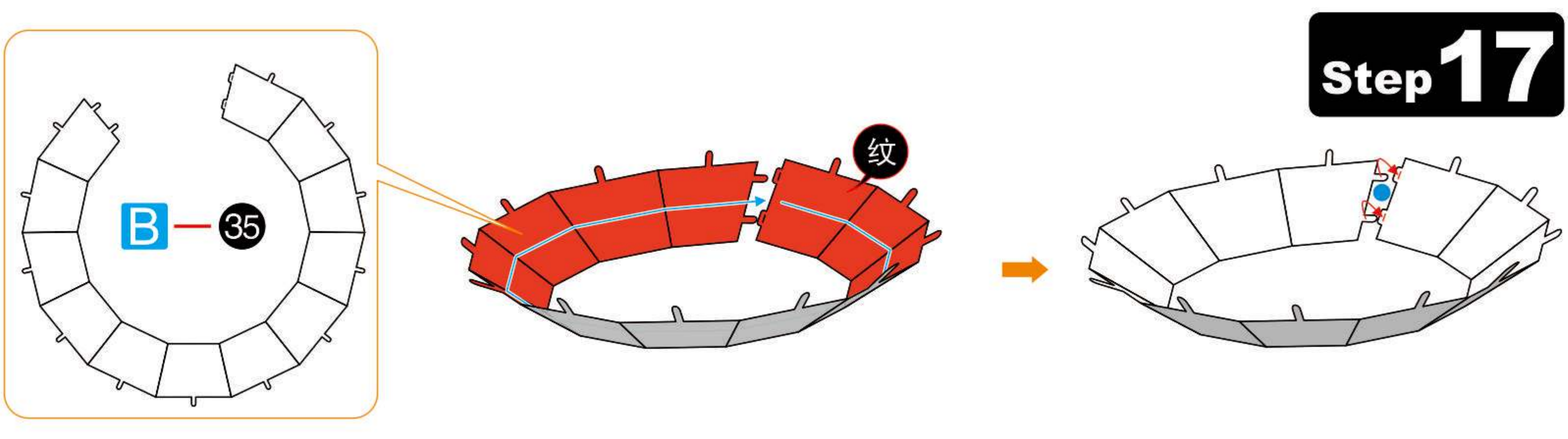

Step 19

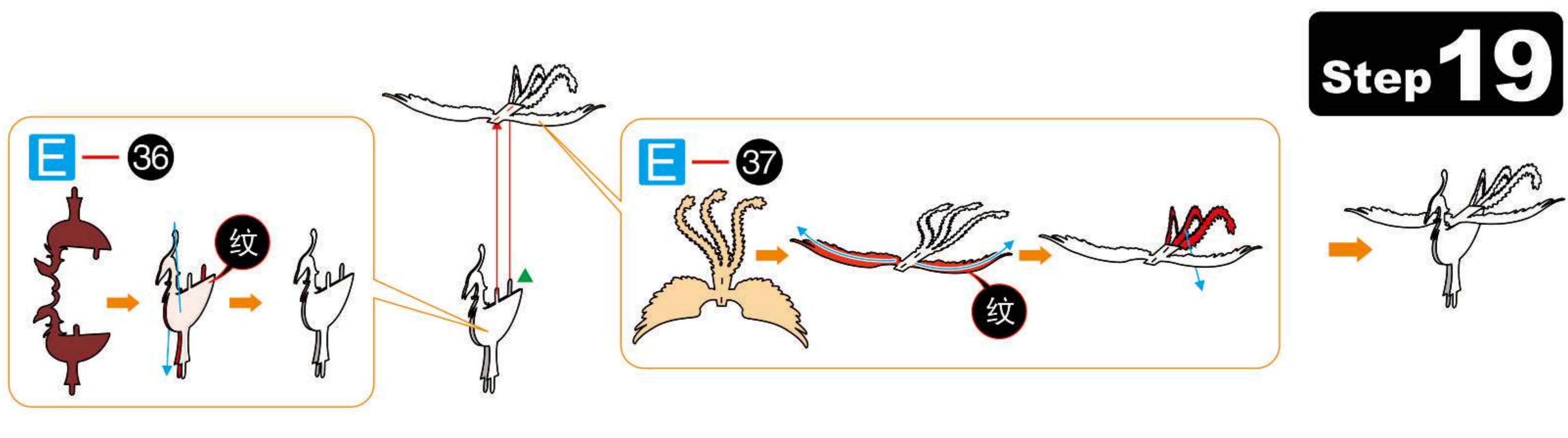

9 10  
11 12

Step 20

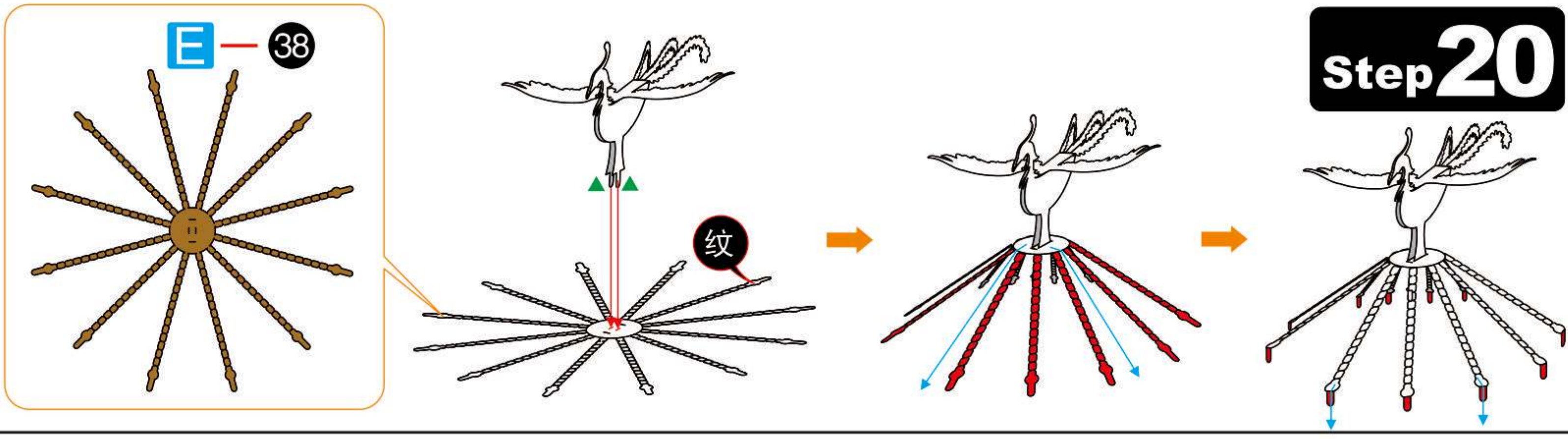

Step 21

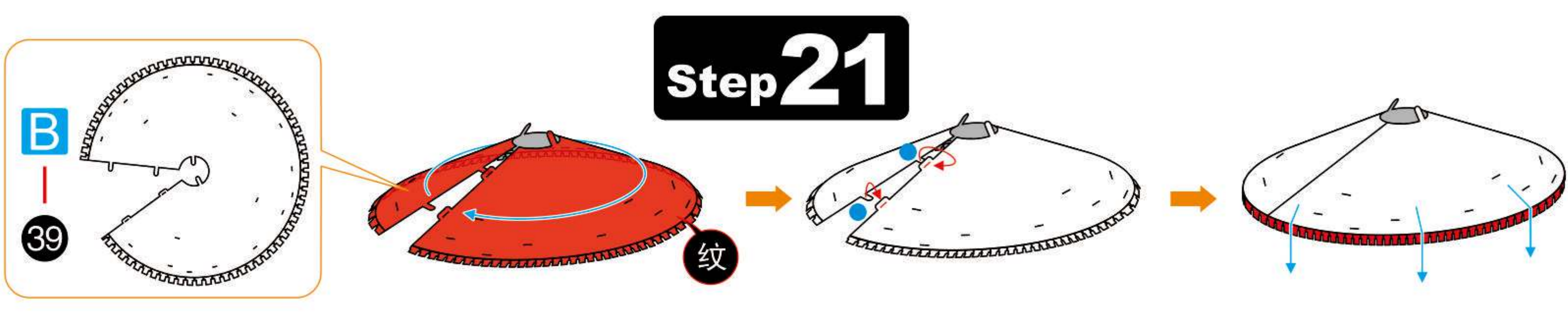

Step 23

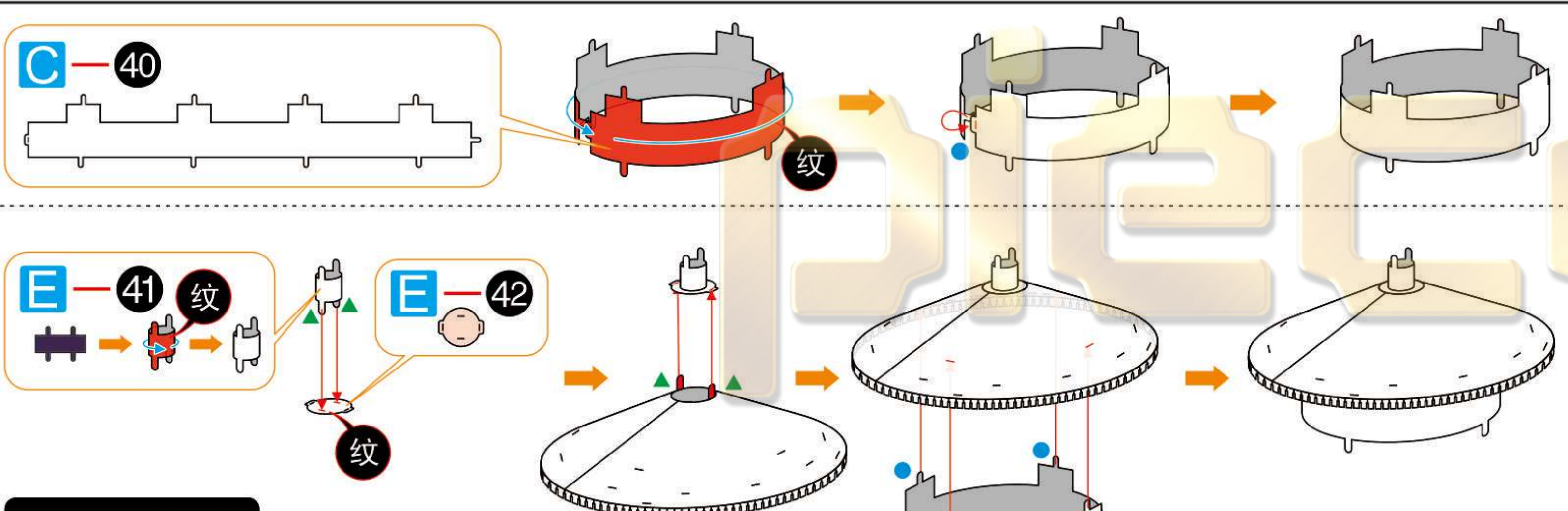
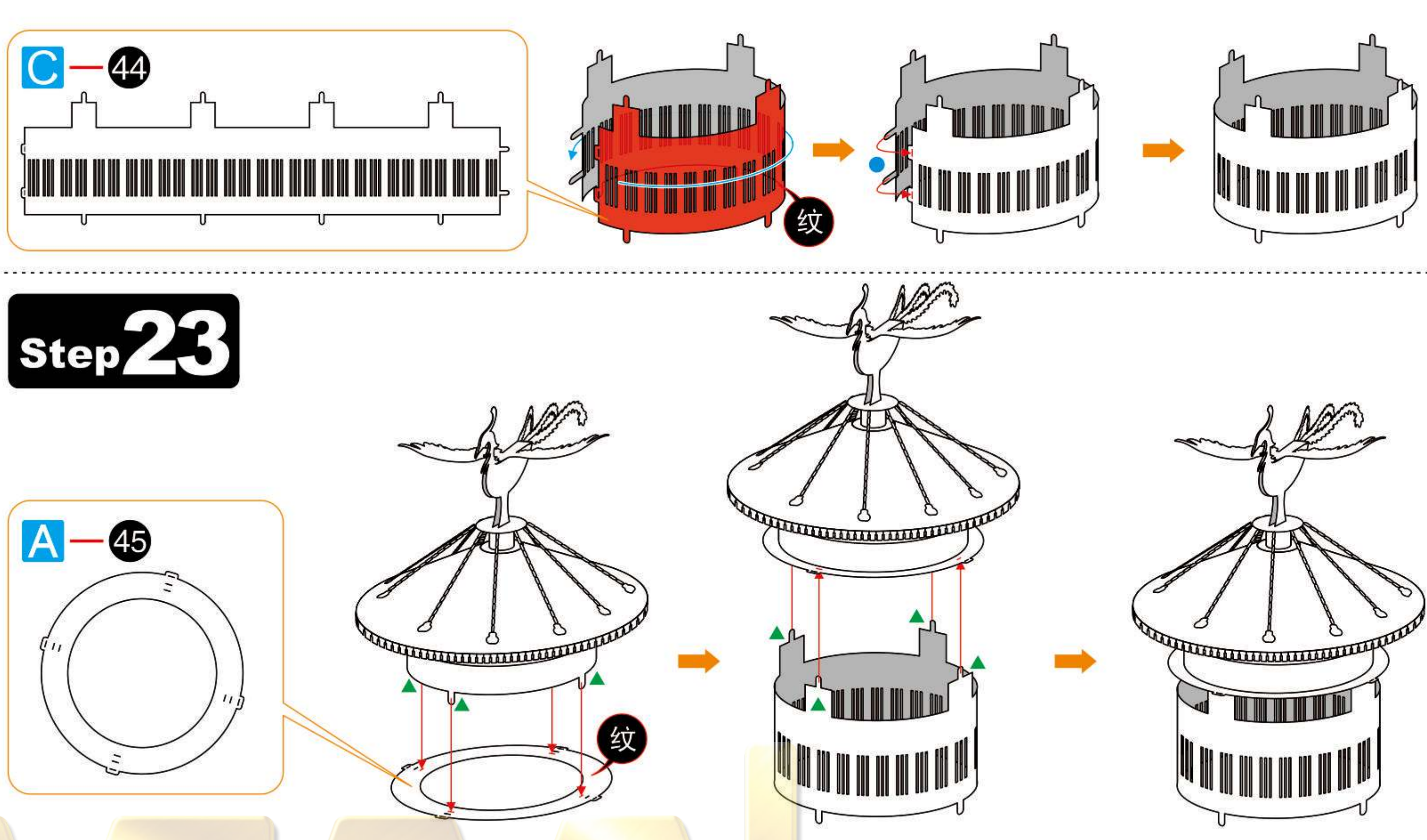

Step 24

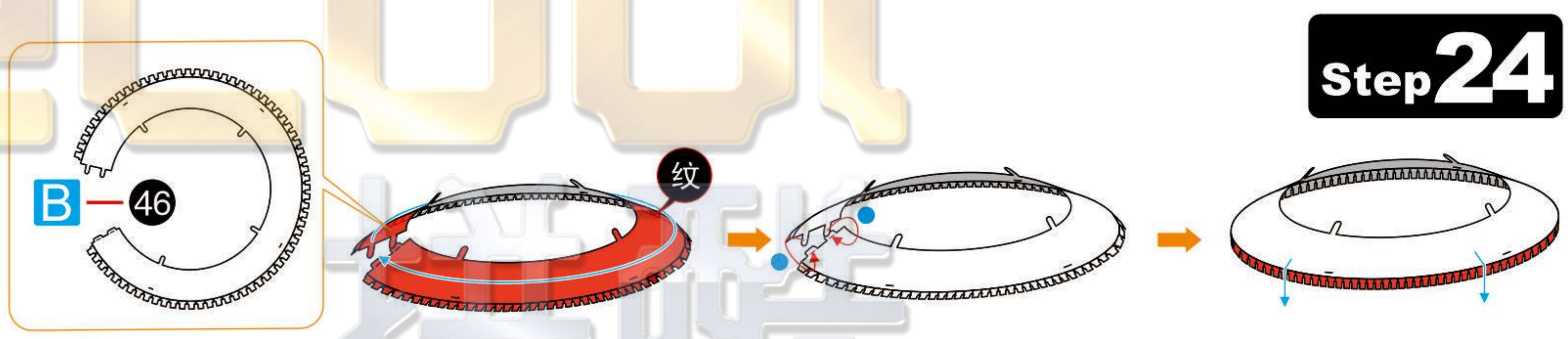

Step 22

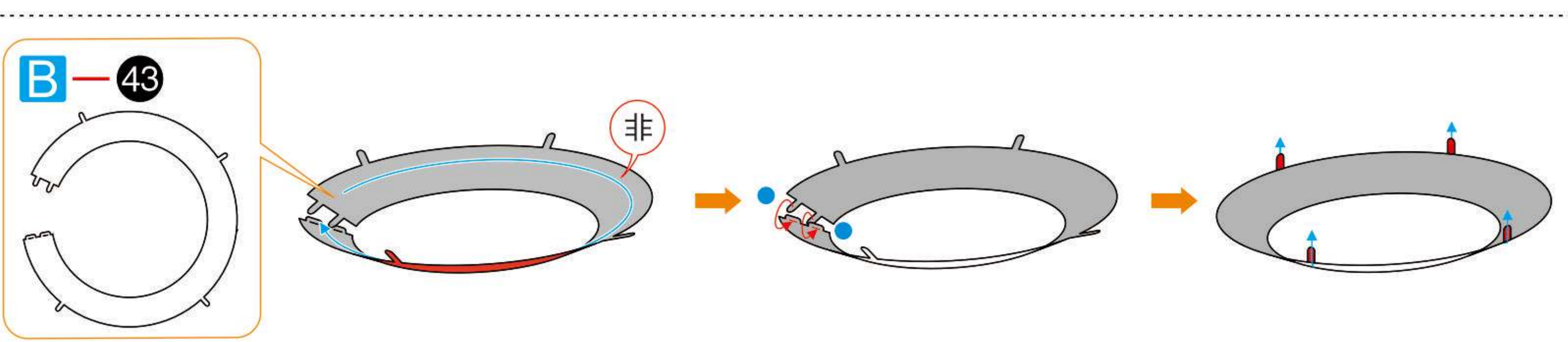

Step 25

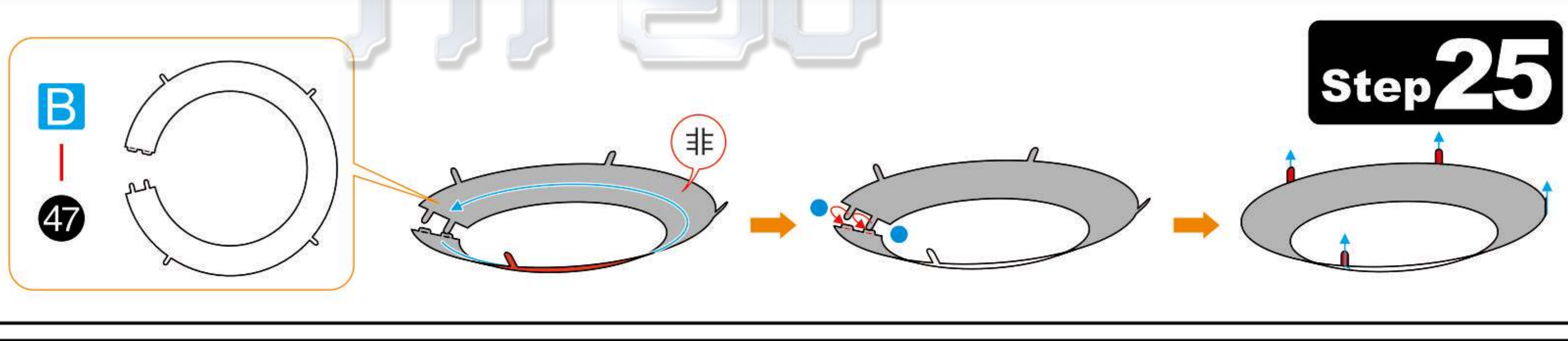

Step 26

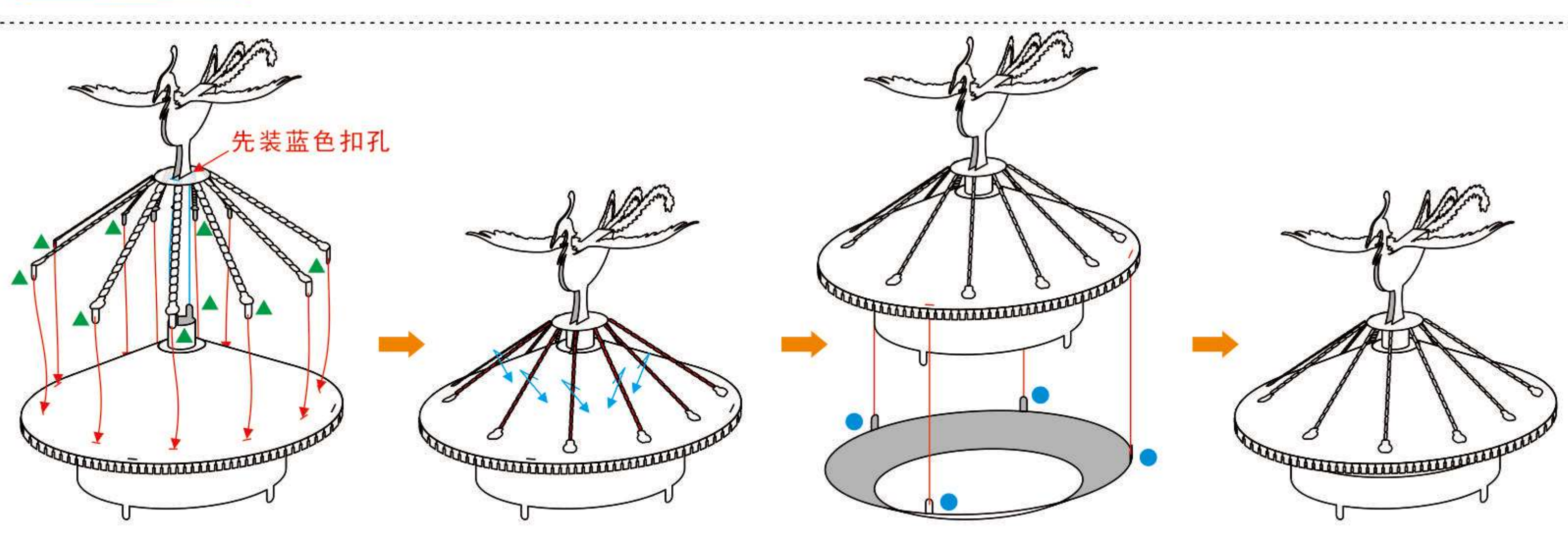
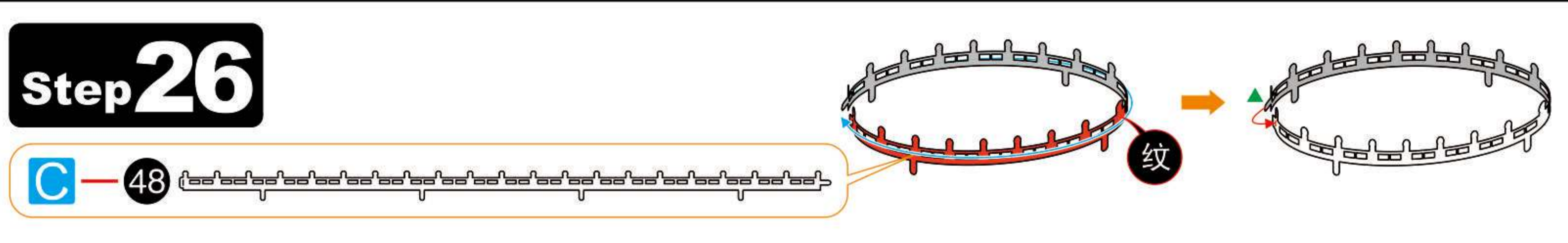

Step 27

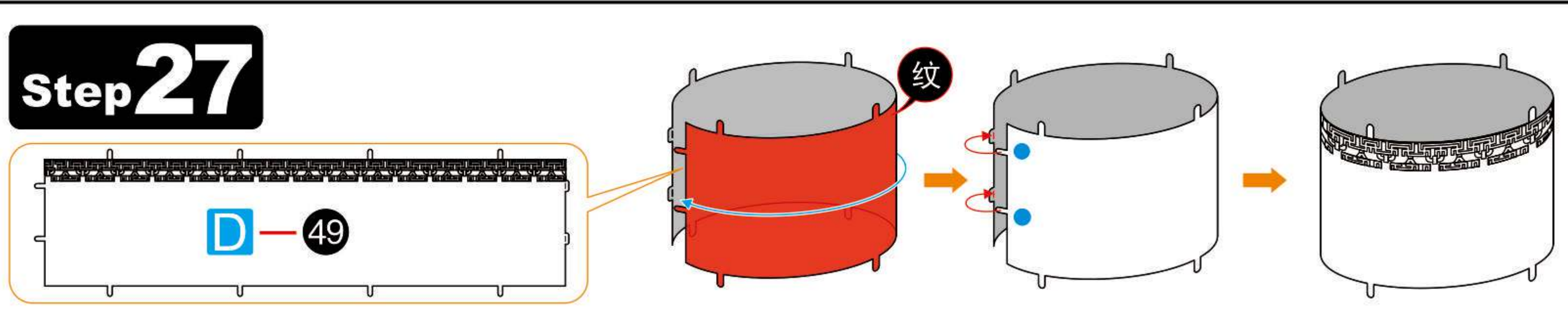

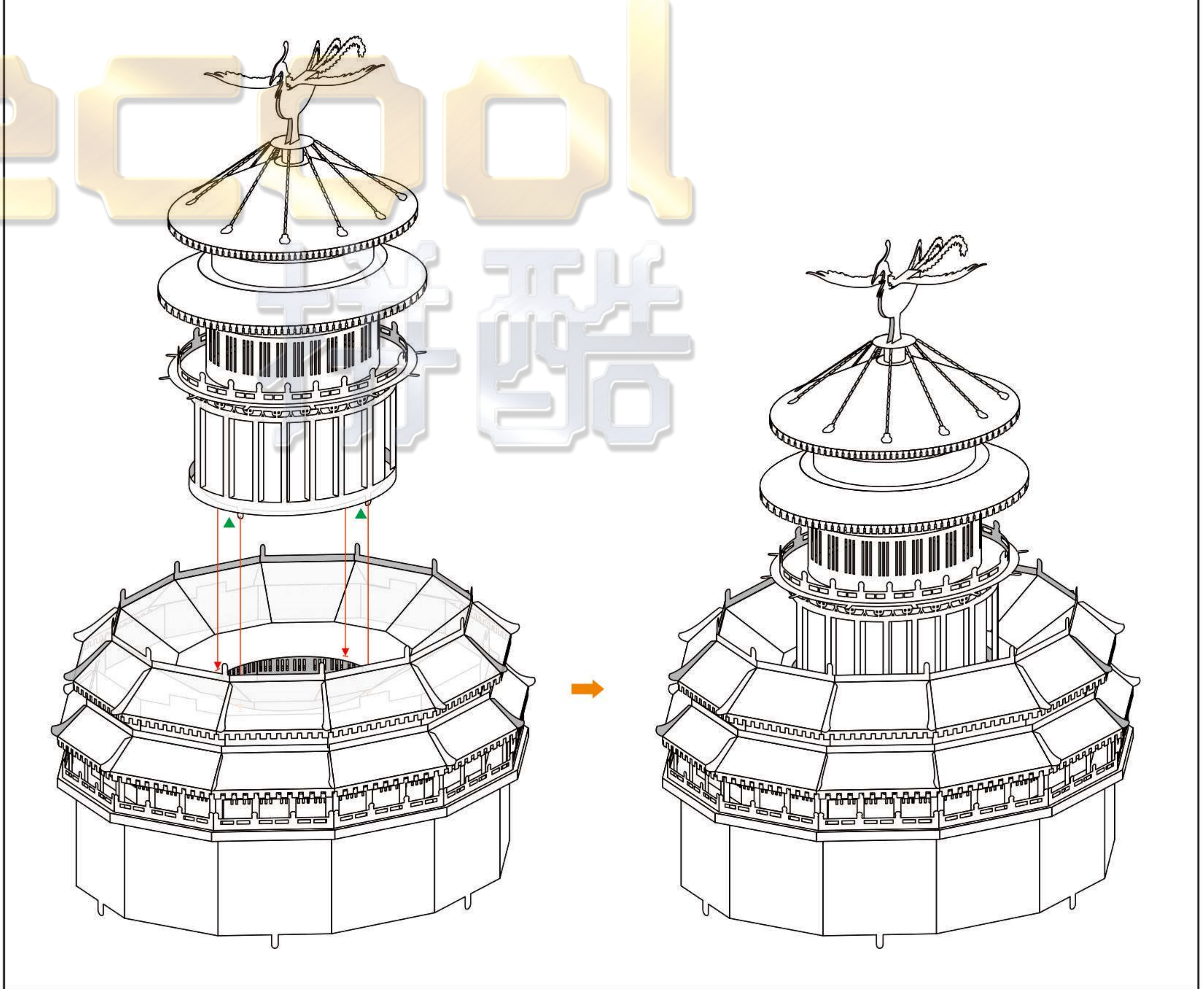
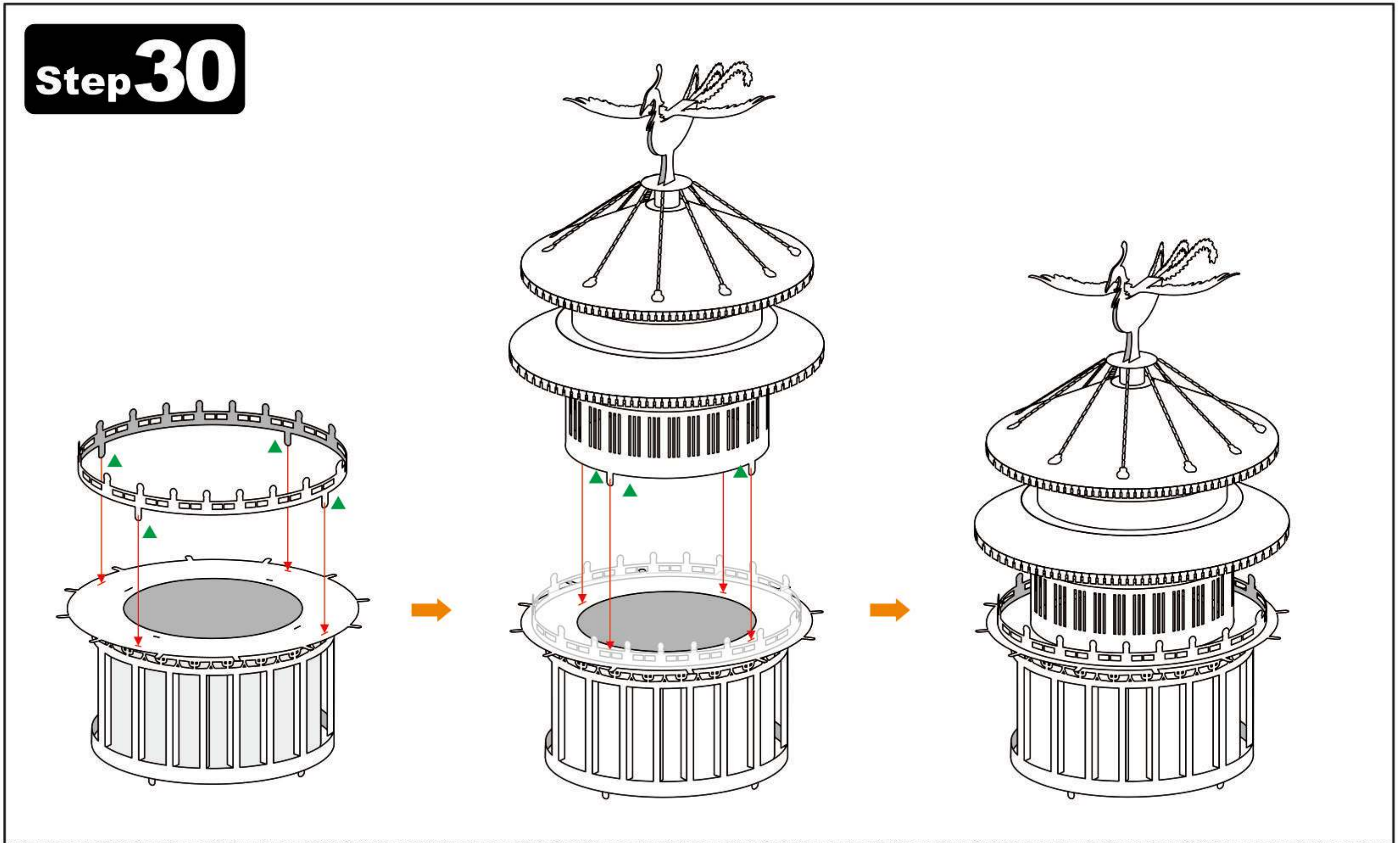
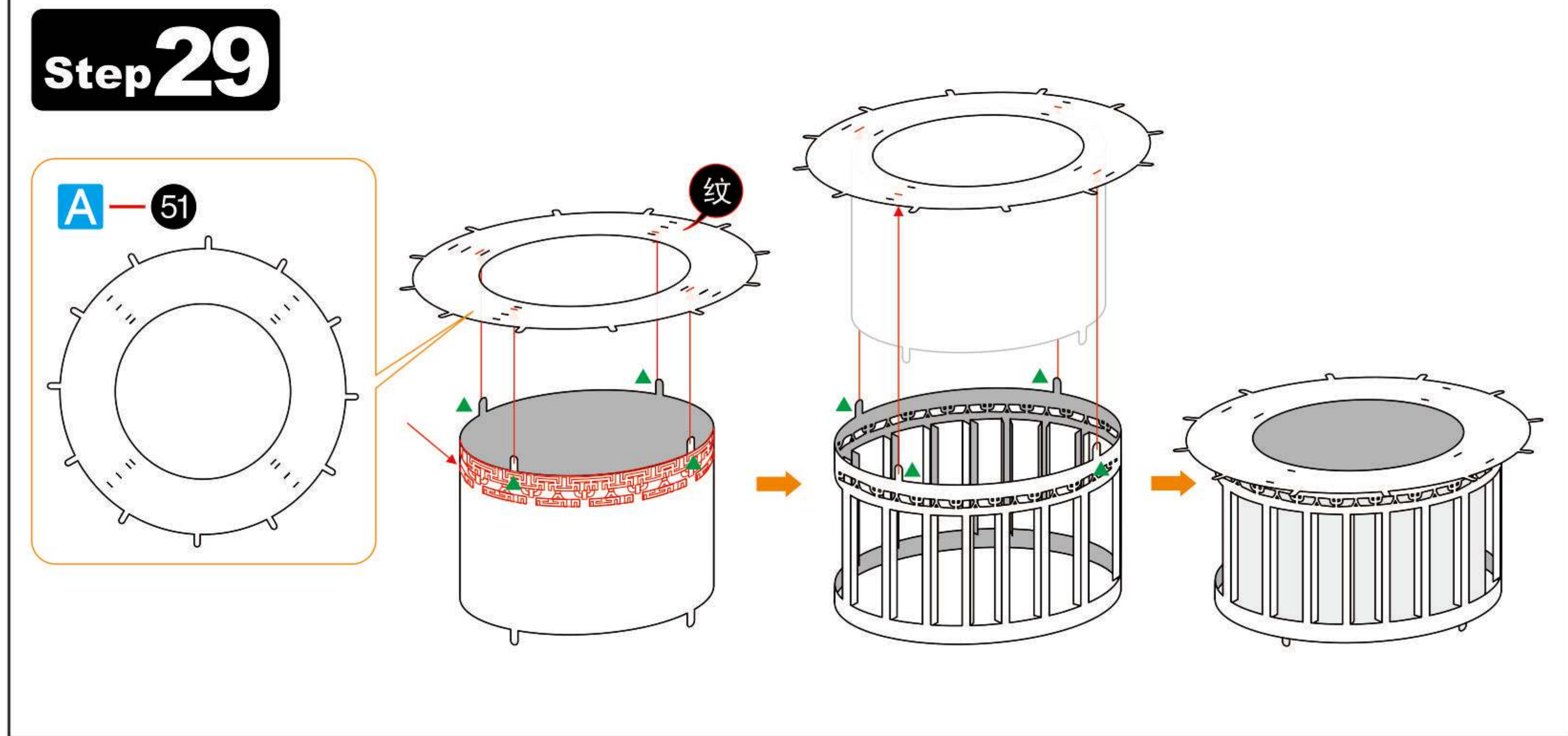
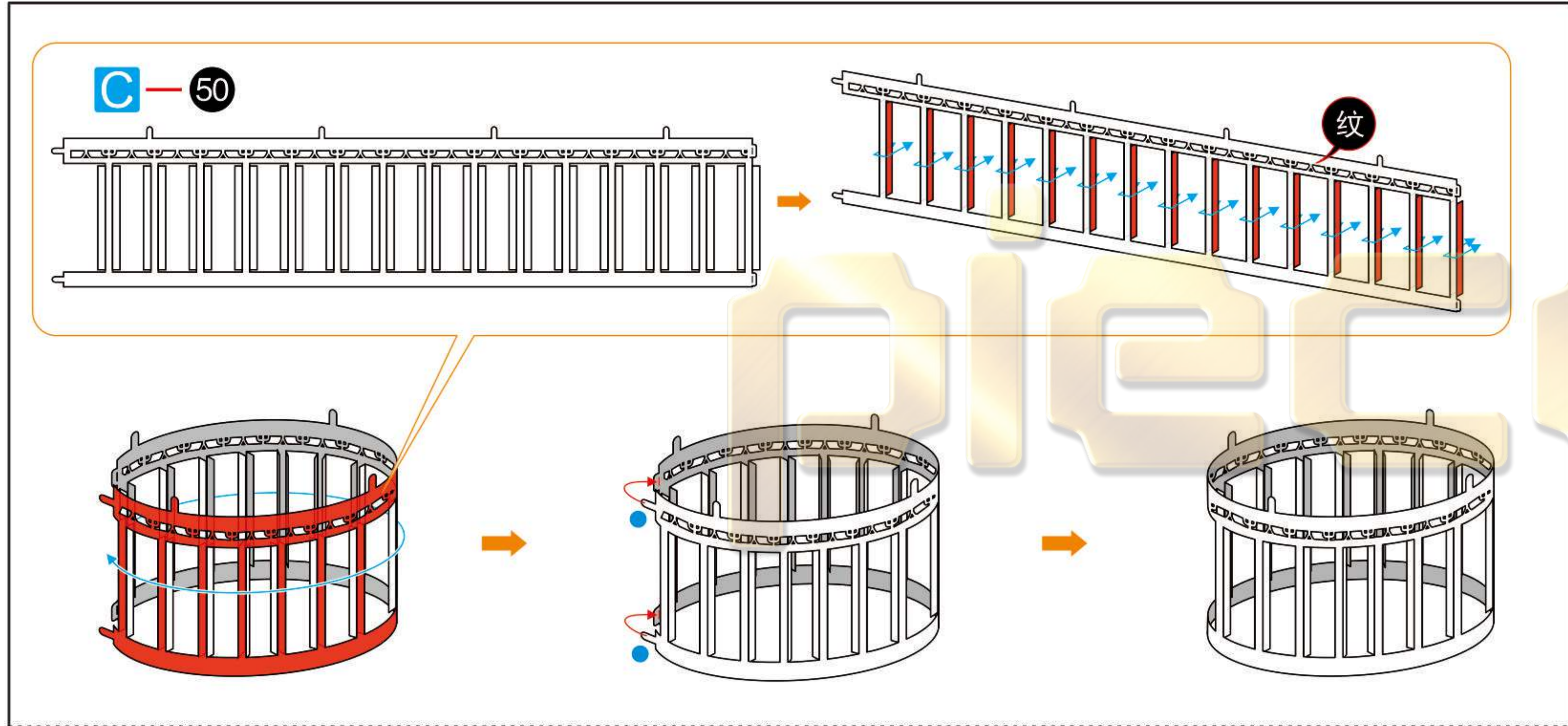
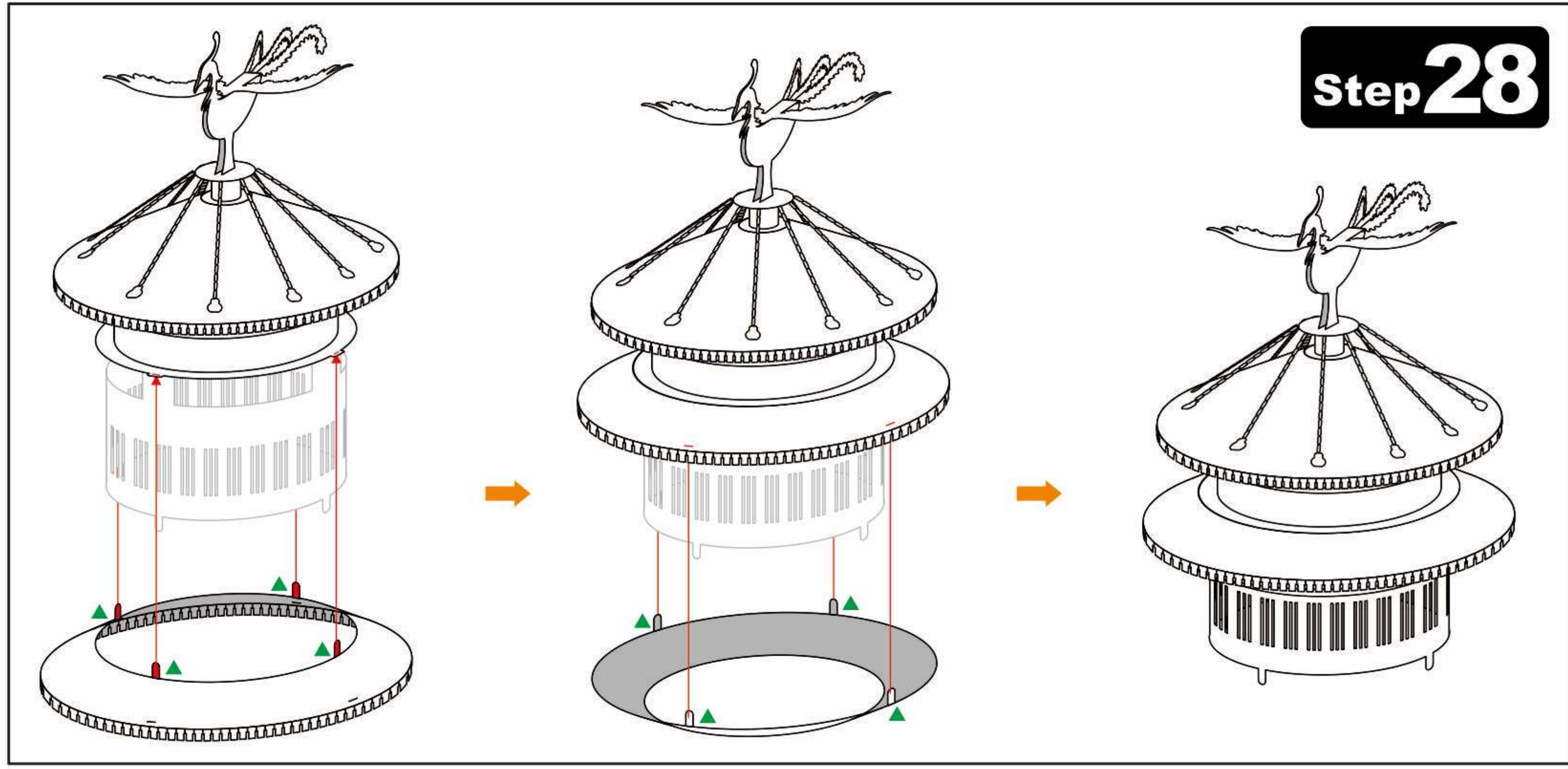

13 14  
15 16

